

TABLE OF CONTENTS P19-08054

Tab	Case Overview	Actions Described
1	190023109-OR051_08-15-19_Redacted	Officer Report
2	190023109-OR059_08-19-19_Redacted	Officer Report
3	190023109-OR061_08-20-19_Redacted	Officer Report

Tab	Investigation/Patrol Reports	Actions Described
4	190023109-Case Report-081219_Redacted	Case Report
5	190023109-Certified Mail Receipt, Ally FNCL	Certified Mail
6	190023109-Certified Mail Receipt, Pinnacle Public Fin Inc	Certified Mail
7	190023109-Certified Mail Receipt, Wells Fargo Auto	Certified Mail
8	190023109- Evidence Log - Scene-082119_Redacted	Crime Scene/evidence/Strike Marks
9	190023109-Crime Scene Diagram	Crime Scene/evidence/Strike Marks
10	190023109-Crime Scene Diagram with Evidence Labels	Crime Scene/evidence/Strike Marks
11	190023109-Deposit Envelope081419_Redacted	Crime Scene/evidence/Strike Marks
12	190023109-Evidence Log - Magazines090419_Redacted	Crime Scene/evidence/Strike Marks
13	190023109-Evidence Log - Post Luther-081419_Redacted	Crime Scene/evidence/Strike Marks
14	190023109-Evidence Log - RCHSMC_Redacted	Crime Scene/evidence/Strike Marks
15	190023109-Evidence Log - Scene-081319_Redacted	Crime Scene/evidence/Strike Marks
16	190023109-Evidence Log 3-081419_Redacted	Crime Scene/evidence/Strike Marks
17	190023109-Evidence Log 4-081419_Redacted	Crime Scene/evidence/Strike Marks
18	190023109-Evidence Log AR-082219_Redacted	Crime Scene/evidence/Strike Marks
19	190023109-Evidence Log Helicopter #N911RP-081319_Redacted	Crime Scene/evidence/Strike Marks
20	190023109-Evidence Log Kia-082119_Redacted	Crime Scene/evidence/Strike Marks
21	190023109-Evidence Log-081319_Redacted	Crime Scene/evidence/Strike Marks
22	190023109-Evidence Log2- Scene081419_Redacted	Crime Scene/evidence/Strike Marks
23	190023109-Evidence Log-MVPD Deputies-081219_Redacted	Crime Scene/evidence/Strike Marks
24	190023109-Evidence Log-RCHSMC_Redacted	Crime Scene/evidence/Strike Marks
25	190023109-Evidence Log-Scene-081419_Redacted	Crime Scene/evidence/Strike Marks
26	190023109-RSO MOVAL Unit Evidence Log-082219_Redacted	Crime Scene/evidence/Strike Marks
27	190023109-Strike Mark Log-081619_Redacted	Crime Scene/evidence/Strike Marks
28	190023109-CHP 180 LIC PLT 6Z11833 CA-082919_Redacted	Impounds/CHP 180/Vehicle Release
29	190023109-CHP 180 LIC PLT 7MYW037 CA-082919_Redacted	Impounds/CHP 180/Vehicle Release
30	190023109-Vehicle Release 090619_Redacted	Impounds/CHP 180/Vehicle Release
31	190023109-Vehicle Release-082919_Redacted	Impounds/CHP 180/Vehicle Release
32	190023109-NIBIN Property Report-102419_Redacted	NIBIN
33	190023109-NIBIN Results-111419_Redacted	NIBIN
34	190023109-NIBIN Results-122319_Redacted	NIBIN
35	190023109-OR002_08-12-19_Redacted	Officer Report
36	190023109-OR003_08-12-19_Redacted	Officer Report
37	190023109-OR004_08-12-19_Redacted	Officer Report
38	190023109-OR005_08-12-19_Redacted	Officer Report
39	190023109-OR006_08-12-19_Redacted	Officer Report
40	190023109-OR007_08-12-19_Redacted	Officer Report
41	190023109-OR008_08-13-19_Redacted	Officer Report
42	190023109-OR009_08-13-19_Redacted	Officer Report
43	190023109-OR0010_08-13-19_Redacted	Officer Report
44	190023109-OR0011_08-13-19_Redacted	Officer Report
45	190023109-OR0012_08-13-19_Redacted	Officer Report
46	190023109-OR0013_08-13-19_Redacted	Officer Report

47	190023109-OR0014_08-13-19_Redacted	Officer Report
48	190023109-OR0015_08-13-19_Redacted	Officer Report
49	190023109-OR0016_08-13-19_Redacted	Officer Report
50	190023109-OR0017_08-13-19_Redacted	Officer Report
51	190023109-OR0018_08-13-19_Redacted	Officer Report
52	190023109-OR0019_08-13-19_Redacted	Officer Report
53	190023109-OR0020_08-13-19_Redacted	Officer Report
54	190023109-OR0021_08-13-19_Redacted	Officer Report
55	190023109-OR0022_08-13-19_Redacted	Officer Report
56	190023109-OR0023_08-13-19_Redacted	Officer Report
57	190023109-OR0024_08-13-19_Redacted	Officer Report
58	190023109-OR0025_08-13-19_Redacted	Officer Report
59	190023109-OR0026_08-13-19_Redacted	Officer Report
60	190023109-OR0027_08-13-19_Redacted	Officer Report
61	190023109-OR0028_08-13-19_Redacted	Officer Report
62	190023109-OR0029_08-13-19_Redacted	Officer Report
63	190023109-OR0030_08-13-19_Redacted	Officer Report
64	190023109-OR0031_08-13-19_Redacted	Officer Report
65	190023109-OR0032_08-13-19_Redacted	Officer Report
66	190023109-OR0033_08-13-19_Redacted	Officer Report
67	190023109-OR0034_08-13-19_Redacted	Officer Report
68	190023109-OR0035_08-13-19_Redacted	Officer Report
69	190023109-OR0036_08-13-19_Redacted	Officer Report
70	190023109-OR0037_08-13-19_Redacted	Officer Report
71	190023109-OR0038_08-13-19_Redacted	Officer Report
72	190023109-OR0039_08-13-19_Redacted	Officer Report
73	190023109-OR040_08-14-19_Redacted	Officer Report
74	190023109-OR041_08-14-19_Redacted	Officer Report
75	190023109-OR042_08-14-19_Redacted	Officer Report
76	190023109-OR043_08-14-19_Redacted	Officer Report
77	190023109-OR044_08-14-19_Redacted	Officer Report
78	190023109-OR045_08-14-19_Redacted	Officer Report
79	190023109-OR046_08-14-19_Redacted	Officer Report
80	190023109-OR047_08-14-19_Redacted	Officer Report
81	190023109-OR048_08-14-19_Redacted	Officer Report
82	190023109-OR049_08-14-19_Redacted	Officer Report
83	190023109-OR050_08-14-19_Redacted	Officer Report
84	190023109-OR052_08-15-19_Redacted	Officer Report
85	190023109-OR053_08-14-19_Redacted	Officer Report
86	190023109-OR054_08-15-19_Redacted	Officer Report
87	190023109-OR055_08-15-19_Redacted	Officer Report
88	190023109-OR056_08-15-19_Redacted	Officer Report
89	190023109-OR057_08-18-19_Redacted	Officer Report
90	190023109-OR058_08-18-19_Redacted	Officer Report
91	190023109-OR060_08-19-19_Redacted	Officer Report
92	190023109-OR061_08-20-19_Redacted	Officer Report
93	190023109-OR062_08-20-19_Redacted	Officer Report
94	190023109-OR065_08-20-19_Redacted	Officer Report
95	190023109-OR066_08-21-19_Redacted	Officer Report
96	190023109-OR067_09-04-19_Redacted	Officer Report
97	190023109-OR068_08-23-19_Redacted	Officer Report
98	190023109-OR069_08-23-19_Redacted	Officer Report
99	190023109-OR070_08-26-19_Redacted	Officer Report

100	190023109-OR071_08-27-19_Redacted	Officer Report
101	190023109-OR074_08-29-19_Redacted	Officer Report
102	190023109-OR075_09-03-19_Redacted	Officer Report
103	190023109-OR076_09-03-19_Redacted	Officer Report
104	190023109-OR077_09-04-19_Redacted	Officer Report
105	190023109-OR078_09-04-19_Redacted	Officer Report
106	190023109-OR080_09-07-19_Redacted	Officer Report
107	190023109-OR081_09-09-19_Redacted	Officer Report
108	190023109-OR082_09-09-19_Redacted	Officer Report
109	190023109-OR083_09-09-19_Redacted	Officer Report
110	190023109-OR084_09-10-19_Redacted	Officer Report
111	190023109-OR085_09-10-19_Redacted	Officer Report
112	190023109-OR086_09-10-19_Redacted	Officer Report
113	190023109-OR087_09-11-19_Redacted	Officer Report
114	190023109-OR088_09-11-19_Redacted	Officer Report
115	190023109-OR089_09-11-19_Redacted	Officer Report
116	190023109-OR090_09-11-19_Redacted	Officer Report
117	190023109-OR091_09-11-19_Redacted	Officer Report
118	190023109-OR092_09-13-19_Redacted	Officer Report
119	190023109-OR093_09-19-19_Redacted	Officer Report
120	190023109-OR094_09-25-19_Redacted	Officer Report
121	190023109-OR096_09-26-19_Redacted	Officer Report
122	190023109-OR097_09-26-19_Redacted	Officer Report
123	190023109-OR098_10-03-19_Redacted	Officer Report
124	190023109-OR100_10-05-19_Redacted	Officer Report
125	190023109-OR101_10-05-19_Redacted	Officer Report
126	190023109-OR102_10-05-19_Redacted	Officer Report
127	190023109-OR103_10-23-19_Redacted	Officer Report
128	190023109-OR105_10-28-19_Redacted	Officer Report
129	190023109-OR106_10-31-19_Redacted	Officer Report
130	190023109-OR107_11-23-19_Redacted	Officer Report
131	190023109-OR108_12-18-19_Redacted	Officer Report
132	190023109-OR109_01-13-20_Redacted	Officer Report
133	190023109-OR110_01-10-20_Redacted	Officer Report
134	190023109-OR111_01-15-20_Redacted	Officer Report
135	190023109-OR112_02-20-20_Redacted	Officer Report
136	190023109-OR113_04-08-20_Redacted	Officer Report
137	190023109-OR114_08-10-20_Redacted	Officer Report
138	190023109-OR115_12-03-20_Redacted	Officer Report
139	190023109-OR116_08-12-19_Redacted	Officer Report
140	190023109-RSO AOD RPT #MC192240003_Redacted	Officer Report
141	190023109-RSO AOD RPT #MC192240003-081919_Redacted	Officer Report
142	190023109 - Property Report AR-082219_Redacted	Property Report
143	190023109 -GMC Property Report- 082119_Redacted	Property Report
144	082019_Redacted	Property Report
145	190023109-CHP Property Report - Unit 4455_Redacted	Property Report
146	190023109-CHP Property Report-081319_Redacted	Property Report
147	190023109-CHP Property Report-Unit4455-0909-19_Redacted	Property Report
148	190023109-Property Report - MVPD Deputies-081219_Redacted	Property Report
149	190023109-Property Report - RCHSMC_Redacted	Property Report
150	190023109-Property Report Helicopter 2 Scene_Redacted	Property Report
151	190023109-Property Report Helmet Emblem-091219_Redacted	Property Report
152	190023109-Property Report Kia-082119_Redacted	Property Report

153	190023109-Property Report Magazine Swabs-090419_Redacted	Property Report
154	190023109-Property Report NIBIN-121119_Redacted	Property Report
155	190023109-Property Report-081519_Redacted	Property Report
156	190023109-Property Report-092519_Redacted	Property Report
157	190023109-Property Report-Scene-081419_Redacted	Property Report
158	190023109-RSO MOVAL Unit Property Report-082219_Redacted	Property Report
159	190023109 - FEIMER Assult Rifle Chart Form090319_Redacted	Weapons Chart
160	190023109- Assult Rifle Chart Form-081319_Redacted	Weapons Chart
161	190023109- CHP Semi-Auto Pistol Chart Form_Redacted	Weapons Chart
162	190023109-CHP Assult Rifle Chart Form OV99- 090319_Redacted	Weapons Chart
163	190023109-CHP Assult Rifle Chart FormVM01-082119_Redacted	Weapons Chart
164	190023109-CHP Semi-Auto Pistol Chart Form - MVPD Deputy-08122019_Redacted	Weapons Chart
165	190023109-CHP Semi-Auto Pistol Chart Form - MVPD Deputy-0813-19_Redacted	Weapons Chart
166	190023109-CHP Semi-Auto Pistol Chart Form MVPD Deputy-081219_Redacted	Weapons Chart
167	190023109-CHP Semi-Auto Pistol Chart Form_Redacted	Weapons Chart
168	190023109-CHP Semi-Auto Pistol Chart Form-082119_Redacted	Weapons Chart
169	190023109-CHP Semi-Auto Pistol Chart Form-MVPD Deputy-081219_Redacted	Weapons Chart
170	190023109-CHP Semi-Auto Pistol Chart Form-MVPD Deputy-081319_Redacted	Weapons Chart
171	190023109-CHP Semi-Auto Pistol Chart Form-MVPD DeputyB-081219_Redacted	Weapons Chart
172	190023109-CHP Shot Gun Chart Form - Unit 1365174, Unit 174-081319_Redacted	Weapons Chart
173	190023109-MVPD Shot Gun Chart Form - Unit 1358192, Unit 10-004-081319_Redacted	Weapons Chart
174	190023109-MVPD Shot Gun Chart Form - Unit 1378955, Unit 11-246-082119_Redacted	Weapons Chart
175	190023109-RPD Semi-Auto Pistol Chart Form - Feimer 1001_Redacted	Weapons Chart
176	190023109-Weapon Accountability Forms-081419_Redacted	Weapons Chart

Tab	Autopsy Report	Actions Described
178	190023109-OR063_08-20-19_Redacted	Autopsy report of Officer Moye
179	190023109-OR072_08-29-19_Redacted	Autopsy report of Officer Moye
180	190023109-OR064_08-20-19_Redacted	Autopsy report of Aaron Luther
181	190023109-OR073_08-29-19_Redacted	Autopsy report of Aaron Luther

Tab	Audio	Actions Described
182	911 Audio	Flash Drive
183	Interviews	Flash Drive
184	SceneClips	Flash Drive

Tab	Photos	Actions Described
185	Photo Thumbnails	

Tab	Video	Actions Described
186	Flash Drive Image	Flash Drive

Tab	Press - Media Release	Actions Described
-----	-----------------------	-------------------

187	190023109-PressRelease	
-----	------------------------	--

Tab	District Attorney	Actions Described
188	190023109-DA Clearance Letters-081821	DA Clearance Letter



Riverside Police Department

Officer Report

File Number:
190023109-051

Administrative Information

Subject:		1111 - OFFICER NEEDS BACK-UP/URGENT RESPONSE			
Date(s) and Time(s) of Occurrence Or Between:		//			
Location Of Occurrence:		Box Springs Blvd / Eastridge Ave RIVERSIDE			
Date/Time Reported:	8/12/2019 5:38:06 PM	Day:			
Date Of Report:	8/15/2019 10:11:59 AM	Type Of Premises:			
NPC:		RD:	PG08	Beat:	3
Was There a Witness To The Crime?					
Can a Suspect Be Named Or Identified?		By Whom?			
Can a Suspect Vehicle Be Identified?		By Whom?			

Code Section Classification:

Records Section

Reporting Officer:	[REDACTED]				
115 Qualified:	Yes				
Send Copies Of This Report To:					
DOJ/NCIC Entered?		Name/ID			
DOJ/NCIC Cancelled?		Name/ID			
APR Sent?		Name/ID			
APB Sent?		Name/ID			

Public Narrative

Officer Involved Shooting Investigation.

Supervisor Approving

Approving Supervisor:	[REDACTED]				
Date Reviewed:	8/15/2019 12:00:00 AM				

Evidence Information

Physical Evidence Present?		Physical Evidence Seized?	
----------------------------	--	---------------------------	--



Riverside Police Department

Officer Report

File Number:
190023109-051

Photographs Taken?		Photographer?	
Weapon Seized?		Weapon(s) Taken For Safety?	
Gang Related?		Sensitive Data?	
Fingerprint Search Made?		Fingerprints Obtained?	
Narcotics Seized?		Narcotics Field Tested?	
Audio Recording Available?		In Car Recording Available?	
Body Worn Camera Recording Available?			
Type of Weapon, Force, Or Device Used?			
Motive:			

Narrative

1 **Narrative:**

2 On 08-12-19, at approximately 1830 hours, I was contacted by Sergeant [REDACTED] and asked to respond
3 to Box Springs Boulevard and Eastridge Avenue, in the City and County of Riverside to assist with an
4 Officer Involved Shooting investigation. I arrived at the scene at approximately 1904 hours.

5
6 I attended a briefing of the incident provided by Riverside Police Sergeant [REDACTED], Riverside County
7 Sheriff's Sergeant [REDACTED] and California Highway Patrol Captain [REDACTED]. The preliminary information
8 from the briefing was California Highway Patrol Officer A. Moye (#21641) was in the process of towing a
9 vehicle he had stopped, when the suspect retrieved a firearm from the vehicle and began firing at
10 Officer Moye and California Highway Patrol Officer [REDACTED] who was also on-scene. Officer
11 Moye and Officer [REDACTED] both sustained gunshot wounds and several officers and deputies from multiple
12 agencies responded to assist with the active shooter.

13
14 During the ensuing shootout, California Highway Patrol Officers [REDACTED]
15 [REDACTED], Riverside Police Department Officer K. Feimer (#1001), and Riverside County Sheriff
16 Department [REDACTED] discharged their firearms.

17
18 CHP Officer Moye was transported to Riverside University Health Systems Medical Center in Moreno
19 Valley in the Riverside Police Department helicopter, Air1. CHP Officer [REDACTED] was transported by a
20 Riverside Sheriff's Department vehicle to the same hospital. The suspect, later identified as Aaron
21 Nathaniel Luther, was transported by American Medical Response ambulance to the same hospital.

22
23 CHP Officer Moye and Luther succumbed to their injuries at the hospital and CHP Officer [REDACTED] was in
24 surgery.

25
26 Following the briefing, Detective [REDACTED] was assigned as the case agent and Detective [REDACTED]
[REDACTED] as the co-case agent. Detective [REDACTED] and Senior Forensic Specialist [REDACTED]



Riverside Police Department

Officer Report

File Number:
190023109-051

30 [redacted] responded to the hospital. Detective [redacted] Detective [redacted] Detective [redacted]
31 [redacted] and Senior Forensic Specialist [redacted] were assigned to process the crime
32 scene. Detective [redacted] and Supervising Forensic Specialist [redacted] were
33 assigned to process/chart the Riverside County Sheriff's Department employees weapons at the Moreno
34 Valley Police station. I was assigned to assist with the scene and processing/charting the California
35 Highway Patrol officers at the CHP, Riverside office located at 8118 Lincoln Avenue, Riverside.

36 Before a walk-through of the scene was done, Riverside County Sheriff Department personnel took
37 aerial photographs by utilizing a drone. The photographs were saved to a thumb drive. I took
38 possession of the thumb drive from RSO Investigator [redacted] at approximately 2050 hours.

39 (I maintained custody of the thumb drive until releasing it to Detective [redacted] on 08-13-19, at approximately 0630 hours.)

40 I did a walk-through of the scene before responding the CHP office.

41 -----
42 **Processing of CHP Officers / Weapons**
43 **8118 Lincoln Avenue, Riverside**

44 **Officer [redacted] 0010 hours**

45
46 Senior Forensic Specialist [redacted] by taking photographs of Officer [redacted] Officer [redacted]
47 was wearing his department issued uniform, which consisted of tan pants, tan short sleeve shirt with a
48 badge on his left chest and a metal name tag on the right chest. The shirt also had California Highway
49 Patrol patches on both sleeves. He was wearing his black Sam Browne duty belt.

50
51 Officer [redacted] rendered his weapon safe and it was then charted by Senior Forensic Technician [redacted]
52 [redacted] report for details.

53
54 Based on the charting of Officer [redacted] handgun he *did not fire any rounds* from this weapon.

55
56 Officer [redacted] maintained possession of his duty weapon. Officer [redacted] did not have a back-up
57 weapon.

58 (Refer to photographs for details)

59
60 Officer [redacted] patrol rifle was processed / charted at the scene by Detective [redacted] and
61 Supervising Forensic Specialist [redacted] Refer to [redacted] report for details.

62
63 **Officer [redacted] 0100 hours**

64
65 Senior Forensic Specialist [redacted] started by taking photographs of Officer [redacted] Officer [redacted] was
66 wearing his department issued uniform, which consisted of tan pants, tan short sleeve shirt with a
67 badge on his left chest and a metal name tag on the right chest. The shirt also had California Highway
68
69
70
71



Riverside Police Department

Officer Report

File Number:
190023109-051

72 Patrol patches on both sleeves. He was wearing his black Sam Browne duty belt. There was a hole near
73 the inner seam of his right leg, near the calf and another similar defect near the inner knee.

74
75 These defects in the uniform pants coincide with injuries Officer [REDACTED] had to his right calf and right
76 inner knee. The injury to his calf was wrapped in gauze but a circular area of blood could be seen
77 through the gauze. The injury to his inner knee was visible was circular in shape but was not wrapped or
78 bleeding at the time of the photographs. Officer [REDACTED] had an abrasion / bruising to his left forearm.
79 (Refer to photographs for details)

80
81 Officer [REDACTED] rendered his weapon safe and it was then charted by Senior Forensic Technician [REDACTED]
82 Refer to [REDACTED] report for details.

83
84 Based on the charting, Officer [REDACTED] fired eighteen (18) rounds from his duty weapon.

85
86 Senior Forensic Specialist [REDACTED] took possession of Officer [REDACTED] uniform pants at 0140 hours.

87
88 Upon completing the charting, I was notified CHP Officer [REDACTED] was at the station and had
89 blood on his uniform. Senior Forensic Specialist [REDACTED] photographed Officer [REDACTED] in his department
90 issued uniform, which consisted of tan pants, tan long sleeve shirt with a badge on his left chest and a
91 metal name tag on the right chest. The shirt also had California Highway Patrol patches on both sleeves.
92 He was wearing his black Sam Browne duty belt.

93
94 Officer [REDACTED] had blood on his left sleeve near the cuff, his left front shirt pocket and just below the left
95 pocket, his right front shirt pocket and his left pant leg.

96
97 Senior Forensic Specialist [REDACTED] took possession of Officer [REDACTED] uniform at 0153 hours.

98
99 *CHP Officer [REDACTED] was present and took photographs as part of the CHP investigation.

100
101 I cleared the CHP office at approximately 0230 hours.

102 -----
103
104 **Charting of Officer Feimer's Unit Shotgun**
105 **Scene**

106
107 At approximately 0600 hours, I returned back to the original crime scene to assist with the investigation.
108 I assisted with a canvas of the scene, locating and identifying items of evidence.

109
110 I also assisted Supervising Forensic Specialist [REDACTED] with charting the shotgun in Officer K.
111 Feimer's marked Riverside Police Department vehicle (#3849). Supervising Forensic Specialist [REDACTED]
112 [REDACTED] photographed the shotgun, which was secured in the shotgun rack. I removed the shotgun and
113 rendered it safe.

114
115 Supervising Forensic Specialist [REDACTED] then charted the weapon. Refer to [REDACTED] report
116 for details.



Riverside Police Department

Officer Report

File Number:
190023109-051

117
118 Based on the charting, the shotgun was not fired during this incident.
119
120 I cleared the scene at approximately 2130 hours.
121
122
123

RIVERSIDE POLICE DEPARTMENT

Date Printed: 10/30/2022 11:06	Case Report Number: 190023109-051	Page: 5 of 5	Ver. 1.3.3
-----------------------------------	--------------------------------------	-----------------	---------------



Riverside Police Department

Officer Report

File Number:
190023109-059

Administrative Information

Subject:	1111 - OFFICER NEEDS BACK-UP/URGENT RESPONSE				
Date(s) and Time(s) of Occurrence Or Between:	//				
Location Of Occurrence:	Box Springs Bldg / Eastridge Ave RIVERSIDE				
Date/Time Reported:	8/12/2019 5:38:06 PM	Day:			
Date Of Report:	8/19/2019 9:39:43 AM	Type Of Premises:			
NPC:		RD:	PG08	Beat:	3
Was There a Witness To The Crime?					
Can a Suspect Be Named Or Identified?			By Whom?		
Can a Suspect Vehicle Be Identified?			By Whom?		

Code Section Classification:

Records Section

Reporting Officer:	[REDACTED]		
115 Qualified:	Yes		
Send Copies Of This Report To:			
DOJ/NCIC Entered?		Name/ID	
DOJ/NCIC Cancelled?		Name/ID	
APR Sent?		Name/ID	
APB Sent?		Name/ID	

Public Narrative

This report will cover [REDACTED] initial response to the crime scene and the charting of Officer Kevin Feimer's duty handgun.

Supervisor Approving

Approving Supervisor:	[REDACTED]
Date Reviewed:	8/20/2019 12:00:00 AM

Evidence Information



Riverside Police Department

Officer Report

File Number:
190023109-059

Physical Evidence Present?		Physical Evidence Seized?	
Photographs Taken?		Photographer?	
Weapon Seized?		Weapon(s) Taken For Safety?	
Gang Related?		Sensitive Data?	
Fingerprint Search Made?		Fingerprints Obtained?	
Narcotics Seized?		Narcotics Field Tested?	
Audio Recording Available?		In Car Recording Available?	
Body Worn Camera Recording Available?			
Type of Weapon, Force, Or Device Used?			
Motive:			

Narrative

1 On 08-12-2019 I responded to Eastridge and and Box Springs regarding the homicide of California
2 Highway Patrol (CHP) Officer Andre Moye. Upon arrival I made contact with Sergeant [REDACTED] with
3 the Riverside Police Department (RPD). I learned that several CHP Officers, Deputies from the
4 Riverside County Sheriff's Department (RCSD) and one Riverside Police Officer was involved in an
5 Officer Involved Shooting (OIS).
6
7
8 Members from the Riverside Police Department Robbery-Homicide Unit, Forensic Specialists,
9 Investigators from the Riverside County District Attorney's Office, RCSD Central Homicide Unit, RCSD
10 Coroner, CHP Investigators as well as command staff from all involved agencies arrived at the
11 shooting scene. I helped coordinate the investigative briefing of the incident with the above listed
12 involved agencies.
13
14
15 RPD Detective [REDACTED] was assigned as the case agent of the investigation. Detective [REDACTED]
16 [REDACTED] was assigned as the co-case agent. Sergeant [REDACTED] was assigned as the supervisor of the
17 crime scene. I responded to the Magnolia Avenue station to assist with the charting of involved
18 officers weapons.
19
20
21 On 08-12-2019 at about 2315 hours, I met with Officer Kevin Feimer, Senior Forensic Specialist [REDACTED]
22 [REDACTED] and Riverside Police Officer's Association Attorney [REDACTED] in the Forensic Bay at the
23 Magnolia Avenue Police Station. The purpose of this meeting was to photograph Officer Kevin
24 Feimer and to chart his issued Glock handgun.
25



Riverside Police Department

Officer Report

File Number:
190023109-059

26
27
28
29
30
31
32
33
34
35
36
37
38
39
40
41
42
43
44
45
46
47
48
49
50
51
52
53
54
55
56
57
58
59
60
61
62
63
64
65
66
67
68

Officer Kevin Feimer Charting of Glock handgun

Glock Model 22, .40 Caliber semi-auto handgun, serial # WDR085

(1) .40 caliber live bullet was located in the chamber of the handgun. (Head stamp Win .40 S&W)

(1) .40 caliber Glock magazine with a 15 round capacity was located in the magazine well of the handgun.

(15) live rounds of .40 caliber cartridges were located in the magazine that was inserted into the magazine well. (Head stamp Win .40 S&W)

(2) additional .40 caliber Glock magazines with a 15 round capacity were found on Officer Feimer's duty belt magazine pouch.

Both magazines found in the magazine pouch of Feimer's duty belt each contained (15) live rounds of .40 caliber cartridges. (Head stamp Win .40 S&W)

A Stream Light TLR flashlight was attached to Officer Feimer's Glock handgun.

At the conclusion of the charting of Officer Feimer's Glock handgun, all issued .40 caliber cartridges were accounted for.

Officer Feimer did not have any secondary firearms on his person.

Officer Kevin Feimer Body Video System (BVS) recording device

Officer Kevin Feimer was wearing his BVS during this officer involved shooting. I later contacted [REDACTED] and learned that he [REDACTED] had responded to the Magnolia Avenue Station prior to my arrival and met with Officer Kevin Feimer. [REDACTED] took Officer Feimer's BVS camera and downloaded the recordings at the Magnolia Avenue Station. [REDACTED] then returned the BVS camera to Officer Feimer.



Riverside Police Department Officer Report

File Number:
190023109-059

69
70
71
72
73
74
75
76
77
78

RIVERSIDE POLICE DEPARTMENT

Date Printed: 10/30/2022 11:24	Case Report Number: 190023109-059	Page: 4 of 4	Ver. 1.3.3
--	---	------------------------	----------------------



Riverside Police Department

Officer Report

File Number:
190023109-061

Administrative Information

Subject:		1111 - OFFICER NEEDS BACK-UP/URGENT RESPONSE			
Date(s) and Time(s) of Occurrence Or Between:		//			
Location Of Occurrence:		Box Springs Bldg / Eastridge Ave RIVERSIDE			
Date/Time Reported:	8/12/2019 5:38:06 PM	Day:			
Date Of Report:	8/20/2019 2:30:14 PM	Type Of Premises:			
NPC:		RD:	PG08	Beat:	3
Was There a Witness To The Crime?					
Can a Suspect Be Named Or Identified?		By Whom?			
Can a Suspect Vehicle Be Identified?		By Whom?			

Code Section Classification:

Records Section

Reporting Officer:	[REDACTED]				
115 Qualified:	Yes				
Send Copies Of This Report To:					
DOJ/NCIC Entered?		Name/ID			
DOJ/NCIC Cancelled?		Name/ID			
APR Sent?		Name/ID			
APB Sent?		Name/ID			

Public Narrative

Supervisor Approving

Approving Supervisor:	[REDACTED]				
Date Reviewed:	8/20/2019 12:00:00 AM				

Evidence Information

Physical Evidence Present?		Physical Evidence Seized?	
----------------------------	--	---------------------------	--



Riverside Police Department

Officer Report

File Number:
190023109-061

Photographs Taken?		Photographer?	
Weapon Seized?		Weapon(s) Taken For Safety?	
Gang Related?		Sensitive Data?	
Fingerprint Search Made?		Fingerprints Obtained?	
Narcotics Seized?		Narcotics Field Tested?	
Audio Recording Available?		In Car Recording Available?	
Body Worn Camera Recording Available?			
Type of Weapon, Force, Or Device Used?			
Motive:			

Narrative

1 **Additional File:**

2 RSO - MC192240003

3

4 **Narrative:**

5 On Monday, August 12, 2019, at about 1800 hours, I learned of an officer involved
6 shooting that was in progress involving California Highway Patrol (CHP) Officers,
7 Riverside Police Officers and other local law enforcement agencies. I responded to the
8 Command Post located at Eastridge St. and Box Springs Rd., in the city of Riverside.

9

10 I attended a briefing of the incident provided by Riverside Police Sergeant [REDACTED]
11 Riverside County Sheriff's Sergeant [REDACTED] and California Highway Patrol Captain
12 [REDACTED]. The preliminary information from the briefing was that California Highway Patrol
13 Officer A. Moye was in the process of impounding a vehicle when the suspect retrieved
14 a firearm from the vehicle and began firing at Officer Moye and assisting California
15 Highway Patrol Officer [REDACTED] who was also on-scene. Officer Moye and Officer [REDACTED]
16 both sustained gunshot wounds and several officers and deputies from multiple
17 agencies responded to assist with the active shooter. During the ensuing shootout,
18 California Highway Patrol Officers [REDACTED] Riverside Police
19 Department Officer K. Feimer, and Riverside County Sheriff Department Deputies
20 [REDACTED] discharged their firearms.

21

22 CHP Officer Moye was transported to Riverside University Health Systems Medical
23 Center via the Riverside Police Department helicopter, Air1. CHP Officer [REDACTED] was
24 transported by a Riverside Sheriff's Department vehicle to the same hospital. The
25 suspect, later identified as Aaron Nathaniel Luther, was transported by American
26 Medical Response ambulance to the same hospital. CHP Officer Moye and Luther
27 succumbed to their injuries at the hospital and CHP Officer [REDACTED] was in critical
28 condition.



Riverside Police Department

Officer Report

File Number:
190023109-061

29
30 Following the briefing, Detective [REDACTED] was assigned as the case agent and
31 Detective [REDACTED] as the co-case agent. Sergeant [REDACTED], Detective [REDACTED]
32 and Senior Forensic Specialist [REDACTED] responded to the RUHS to collect evidence on
33 the involved officers, the transport vehicles and the suspect. Detective [REDACTED] and
34 Supervising Forensic Specialist [REDACTED] were assigned to process/chart the
35 Riverside County Sheriff's Department employees weapons at the Moreno Valley Police
36 station. Detective [REDACTED] was assigned to assist with the scene and processing/charting
37 the California Highway Patrol officers at the CHP, Riverside office located at 8118
38 Lincoln Avenue, Riverside. Detective [REDACTED], Detective [REDACTED], Detective [REDACTED]
[REDACTED] and Senior Forensic Specialist [REDACTED] were assigned to process the crime
40 scene. I was assigned as the Scene Supervisor.

41
42 I participated in a scene walk-through. Based on the size of the scene, the evidence
43 needed to be collected and the fact that it was dark, we determined we would be
44 better suited to hold the scene until daylight. This would ensure a more thorough
45 canvass and collection.

46 Patrol Sgt. [REDACTED] and I coordinated the overall containment of the scene including
47 having two detectives [REDACTED] within the scene keeping watch of the
48 evidence including the Police vehicles, civilian vehicles and fire vehicles. I cleared the
49 scene at about 0300 hours and returned the following morning at 0600 hours.

50 At about 0800 hours, I called Detective [REDACTED] and Officer [REDACTED] to the scene to record
51 video and take still photographs of the scene using a department unmanned Arial
52 System (Drone).

53 I maintained scene supervision throughout the day and oversaw the processing of the
54 evidence until about 0430 hours, on Wednesday, August 14, 2019. During that time I
55 coordinated the release of vehicles inside the scene that were no longer needed. After
56 leaving the scene I responded to the Magnolia Police Station where I coordinated the
57 placement of (9) involved vehicles held for evidence. Three were placed inside
58 evidence bays and the remaining were placed in our secured parking lot. I cleared at
59 about 0500 hrs. NFI.

60
61



Riverside Police Department

Case Report

File Number:
190023109

Administrative Information

Subject:		1111 - OFFICER NEEDS BACK-UP/URGENT RESPONSE	
Occurred On (Date and Time)	8/12/2019 12:00:00 AM	Occurred Day:	Monday
Or Between (Date and Time)			
Location Of Occurrence:	Box Springs Bldg / Eastridge Ave RIVERSIDE		
Date/Time Reported:	8/12/2019 5:38:06 PM		
Date Of Report:	8/12/2019 11:16:18 PM		
Type Of Premises:			
NPC:		RD:	PG08
		Beat:	3
Was There a Witness To The Crime?			Yes
Can a Suspect Be Named Or Identified?	Yes	By Whom?	
Can a Suspect Vehicle Be Identified?	Yes	By Whom?	

Code Section Classification:

Offense	Code Section
MURDER:SECOND DEGREE ON PEACE OFFICER	187(A)
Completed	Yes

Records Section

Reporting Officer:			
115 Qualified:	Yes		
DOJ/NCIC Entered?	Name/ID		
DOJ/NCIC Cancelled?	Name/ID		
APR Sent?	Name/ID		
APB Sent?	Name/ID		

Public Narrative

--	--

Supervisor Approving

Approving Supervisor:			
Date Reviewed:	8/15/2019 12:00:00 AM		



Riverside Police Department

Case Report

File Number:
190023109

Victim Information

PURSUANT TO CALIFORNIA PENAL CODE SECTION 293(a)/CONFIDENTIAL FORM(S) ATTACHED?:							
Code:	V1	Name:	Society				
Victim Type:	Individual			Will the victim prosecute?			
Sex:	Male	Race:	Unknown	DOB:			
Height:			Weight:				
Hair:			Eyes:				
Attire:							
Employer/School				Occupation/Grade			
Notes:							

Victim Aliases

Victim Scars, Marks and Tattoos

Scar, Mark, Tattoo	Scar, Mark, Tattoo Location	Description

Victim Vehicle Information:

Make	Model	Year	Color	License No.

Victim Domestic Violence (if applicable) Information:

Emotional State	Appearance	Injuries	Sobriety/Drug
Victim Advised of Citizen's Arrest Rights?			
Victim Given "Alternatives To Domestic Violence" Card?			
Victim Given Department Phone Number?			
Victim Advised Of Public Record/Privacy, 293(a) PC?			

Victim Injuries:

Injuries:	
If Treated For Injuries, By Whom?	
If Hospitalized, Where?	
Date/Time:	
Nature of Injuries:	
Injury Weapons:	



Riverside Police Department

Case Report

File Number:
190023109

Victim Addresses:

Address Type	Address	City, State ZIP	County
--------------	---------	-----------------	--------

Victim Phones:

Phone Type	Phone Number
------------	--------------

Evidence Information

Physical Evidence Present?	No	Physical Evidence Seized?	
Photographs Taken?		Photographer?	
Weapon Seized?		Weapon(s) Taken For Safety?	Gang Related?
Fingerprint Search Made?		Fingerprints Obtained?	Sensitive Data?
Narcotics Seized?		Narcotics Field Tested?	Audio Recording Available?
In Car Recording Available?		Body Worn Camera Recording Available?	
Type of Weapon, Force, Or Device Used?			
Motive:			

Property Information

Addendums (if applicable)

Narrative

- 1 DETAILS: On 8/12/2019 at approximately 5:38 p.m., I was near Chicago Ave. and Central Ave. in the
- 2 City and County of Riverside in my department issued police vehicle when I heard a call broadcast on
- 3 the police radio that officers of the California Highway Patrol were being fired upon and requesting
- 4 emergency assistance at Eastridge Ave. and Box Springs Blvd.
- 5
- 6 I began driving toward that location when I heard that the suspect was possibly armed with an "AR-
- 7 15" type rifle and had officers pinned down. I drove onto Interstate 215 South and as I was
- 8 approaching Eastridge Ave. on the 215, I saw a smaller white pickup truck and a black and white
- 9 marked CHP vehicle on the overpass for some railroad tracks facing westbound. Traffic on the
- 10 offramp was stopped and there were some people hiding behind vehicles and others apparently
- 11 recording videos with their mobile phones. There were multiple police vehicles arriving at the scene.



Riverside Police Department

Case Report

File Number:
190023109

12
13 I parked on the offramp and exited my vehicle and put on my ballistic vest with "police" markings for
14 protection and to identify myself because I was in plainclothes. I also retrieved my patrol rifle and
15 police radio, then I ran up the offramp toward Eastridge Ave. When I reached the top of the offramp,
16 there was a Riverside County Sheriffs Moreno Valley contract police unit parked on the North side of
17 Eastridge Ave., facing West. There was a Riverside County Sheriff's deputy taking cover behind the
18 driver's door with his weapon drawn. I then took cover behind the passenger side door of this
19 vehicle and I could see a CHP Officer lying on the ground with other officers near him. I heard
20 someone yell the suspect was down and to move the officer. The Riverside Police Helicopter was
21 landing in the intersection of Eastridge Ave. and the Interstate 215 southbound exit. I then saw
22 multiple officers carry the CHP officer into the Riverside Police helicopter and put him inside. I also
23 saw several officers helping a CHP Officer who had a large bleeding wound to one of his legs in the
24 shin area. I could hear the Riverside Police helicopter taking off and heard someone say on the police
25 radio that the helicopter was on the way to the hospital.

26
27 In front of the white pickup truck I could see multiple officers and deputies. I then approached the
28 area of the white truck with a group of other officers and deputies. There was a CHP motorcycle
29 parked behind the white pickup truck and a CHP Ford Explorer police vehicle with what appeared to
30 be multiple bullet strikes to the front of the vehicle. Behind the CHP Explorer was another CHP unit
31 and on the ground near the front of that unit I saw a black "AR-15" style rifle and a black handgun
32 and several handgun magazines lying on the ground. Around these weapons there was also a large
33 amount of what appeared to be blood on the ground. Behind this CHP car, there was a Ford Crown
34 Victoria Moreno Valley Police unit with broken glass on the ground near the driver side window and
35 the driver door was standing open. A few moments later I heard one of the officers or deputies say
36 there was no more shooters and they had the suspect. I saw the CHP Officer with the leg wound
37 being helped into the rear seat of a white CHP unit. The driver of that unit said he was taking the
38 wounded officer to the hospital and left the scene. I then broadcast on the police radio that the
39 scene was "Code 4" meaning emergency assistance was no longer because I could hear and see
40 multiple police vehicles driving quickly to the area with sirens and lights.

41
42 After the scene was stabilized, I made contact with Sgt. [REDACTED] who told me to take up a perimeter
43 position at the top of the southbound Interstate 215 offramp at Eastridge Ave. and start a crime
44 scene log. I retrieved a crime scene log and began documenting the names of personnel who were
45 already at the scene. I maintained my position at the top of the offramp until I was relieved by Officer
46 [REDACTED], who I passed the crime scene log off to. Lt. [REDACTED] then asked me to assist CHP officers
47 with perimeter scene security where several witnesses were moved to at the top of the onramp to
48 Interstate 215 South from Eastridge Ave. I maintained this position for some time when I was notified
49 by CHP Officers there were multiple witnesses who were wanting to leave the scene and needed to
50 be interviewed.

51
52 I then walked down to the command post area near Eastridge Ave. and Box Springs Blvd. where I
53 made contact with Lt. [REDACTED] and informed him of the witnesses who were wanting to leave the
54 scene. Lt. [REDACTED] said he would send investigators to that location to speak to the witnesses. After

Date Printed: 9/28/2022 9:55 AM	Case Report Number: 190023109-001	Page: 4 of 5	Ver. 1.3.3
---	---	------------------------	----------------------



Riverside Police Department

Case Report

File Number:
190023109

55 making contact with Lt. [REDACTED], I spoke to Lt. [REDACTED] and asked if I could be of any further
56 assistance. By that time, there was a multitude of personnel from several agencies on scene and Lt.
57 [REDACTED] told me that I could clear the scene.
58
59 End of narrative.
60
61
62

RIVERSIDE POLICE DEPARTMENT

Date Printed: 9/28/2022 9:55 AM	Case Report Number: 190023109-001	Page: 5 of 5	Ver. 1.3.3
------------------------------------	--------------------------------------	-----------------	---------------

SENDER: COMPLETE THIS SECTION

- Complete items 1, 2, and 3. Also complete item 4 if Restricted Delivery is desired.
- Print your name and address on the reverse so that we can return the card to you.
- Attach this card to the back of the mailpiece, or on the front if space permits.

1. Article Addressed to:

ALLY FNCL
P.O. BOX 8128
COCKEYSVILLE MD
21030

2. Article Number
(Transfer from service label)

7016 1970 0000 0286 1750

COMPLETE THIS SECTION ON DELIVERY

A. Signature
X *Stephanie Daughtry* Agent Addressee

B. Received by (Printed Name) C. Date of Delivery
S. Daughtry

D. Is delivery address different from item 1? Yes
If YES, enter delivery address below: No

3. Service Type
 Certified Mail® Priority Mail Express™
 Registered Return Receipt for Merchandise
 Insured Mail Collect on Delivery

4. Restricted Delivery? (Extra Fee) Yes

SENDER: COMPLETE THIS SECTION

- Complete items 1, 2, and 3. Also complete item 4 if Restricted Delivery is desired.
- Print your name and address on the reverse so that we can return the card to you.
- Attach this card to the back of the mailpiece, or on the front if space permits.

1. Article Addressed to:
 PINNACLE PUBLIC FIN INC
 8377 E. HARTFORD DR.
 STE. 115
 SCOTTSDALE AZ
 85255

2. Article Number
 (Transfer from service label)

7016 1970 0000 0286 1774

COMPLETE THIS SECTION ON DELIVERY

A. Signature Agent
 Addressee

B. Received by (Printed Name) C. Date of Delivery

D. Is delivery address different from item 1? Yes
 If YES, enter delivery address below: No

3. Service Type
 Certified Mail® Priority Mail Express™
 Registered Return Receipt for Merchandise
 Insured Mail Collect on Delivery

4. Restricted Delivery? (Extra Fee) Yes

SENDER: COMPLETE THIS SECTION

- Complete items 1, 2, and 3. Also complete item 4 if Restricted Delivery is desired.
- Print your name and address on the reverse so that we can return the card to you.
- Attach this card to the back of the mailpiece, or on the front if space permits.

1. Article Addressed to:

WELLS FAREO AUTO
P.O. BOX 997517
SACRAMENTO CA
95899

2. Article Number
(Transfer from service label)

7016 1970 0000 0286 1781

PS Form 3811, July 2013

Domestic Return Receipt

COMPLETE THIS SECTION ON DELIVERY

A. Signature Agent
X  Addressee

B. Received by (Printed Name) C. Date of Delivery

D. Is delivery address different from item 1? Yes
If YES, enter delivery address below: No

AUG 20 2019

3. Service Type
 Certified Mail® Priority Mail Express™
 Registered Return Receipt for Merchandise
 Insured Mail Collect on Delivery

4. Restricted Delivery? (Extra Fee) Yes

EVIDENCE LOG

FILE: 190023109 P.O.R. # 9: RSO UNIT #18-003
 P.O.R. # 10: KIA OPTIMA, CA LICENSE #7MYW037
 DATE: 8/13/2019 P.O.R. # 11: EASTRIDGE AVE. AND 215
 FREEWAY OVERPASS
 LOCATION: EASTRIDGE AVE. AND 215 P.O.R. #
 FREEWAY OVERPASS
 SPECIALIST: [REDACTED] P.O.R. #

EVID NUM	COLL TIME	DESCRIPTION OF EVIDENCE	POR	LOCATION OF EVIDENCE
VM01	2352	"SIG SAUER" 5.56 NATO RIFLE, MODEL SIG M400, SERIAL #2695CHP WITH STRAP (FIREARM FOR CHP OFFICER [REDACTED])	9	REAR SEAT OF RSO UNIT #18-003
VM01-A	2352	RIFLE MAGAZINE WITH (3) "SPEER 17 223 REM" CARTRIDGES (LIVE)	9	REAR SEAT OF RSO UNIT #18-003
VM01-B	2352	RIFLE MAGAZINE WITH (20) "SPEER 17 223 REM" CARTRIDGES (LIVE)	-	REAR SADDLE MAGAZINE HOLDER (OPPOSITE EJECTOR PORT)
VM01-C	2352	RIFLE MAGAZINE WITH (20) "SPEER 17 223 REM" CARTRIDGES (LIVE)	-	REAR SADDLE MAGAZINE HOLDER (EJECTOR PORT SIDE)
		<u>8/14/2019</u>		
OV99	0230	"SAVAGE" .22 LR CALIBER RIFLE SEMI AUTO, MODEL 64, SERIAL #2937401, AND DETACHED SCOPE INSIDE BLACK RIFLE BAG	10	TRUNK OF KIA OPTIMA, CALIFORNIA LICENSE #7MYW037
OV99-A	0230	BLACK RIFLE MAGAZINE	-	RIFLE BAG OF ITEM #OV99
OV99-B	0230	FIREARMS SAFETY CERTIFICATE FOR MCKENZIE [REDACTED])	-	RIFLE BAG OF ITEM #OV99
OV58	0252	"SMITH & WESSON" .40 CALIBER SEMI-AUTO PISTOL, MODEL M&P, SERIAL #JBC8786 (POSSIBLE BLOOD & DIRT)	11	STREET
OV58-A	0252	PISTOL MAGAZINE (EMPTY) WITH POSSIBLE BLOOD	-	REMOVED FROM ITEM #OV58

**KEY: POR= POINT OF REFERENCE, N = NORTH, S = SOUTH, E = EAST, W = WEST, HT = HEIGHT
 COLL. TIME = COLLECTION TIME, EVID. NUM= EVIDENCE ITEM NUMBER**

EVIDENCE LOG

EVID NUM	COLL TIME	DESCRIPTION OF EVIDENCE	POR	LOCATION OF EVIDENCE
OV57	0301	"SMITH & WESSON" .40 CALIBER BLACK PISTOL MAGAZINE (EMPTY)	11	STREET
OV53	0306	"SMITH & WESSON" .40 CALIBER BLACK PISTOL MAGAZINE WITH (3) "FEDERAL 40 S&W" CARTRIDGES	11	STREET
OV47	0315	"SMITH & WESSON" .40 CALIBER BLACK PISTOL MAGAZINE WITH (8) "FEDERAL 40 S&W" CARTRIDGES	11	STREET
		VM = ██████████		
		OV = ██████████		

**KEY: POR= POINT OF REFERENCE, N = NORTH, S = SOUTH, E = EAST, W = WEST, HT = HEIGHT
COLL. TIME = COLLECTION TIME, EVID. NUM= EVIDENCE ITEM NUMBER**

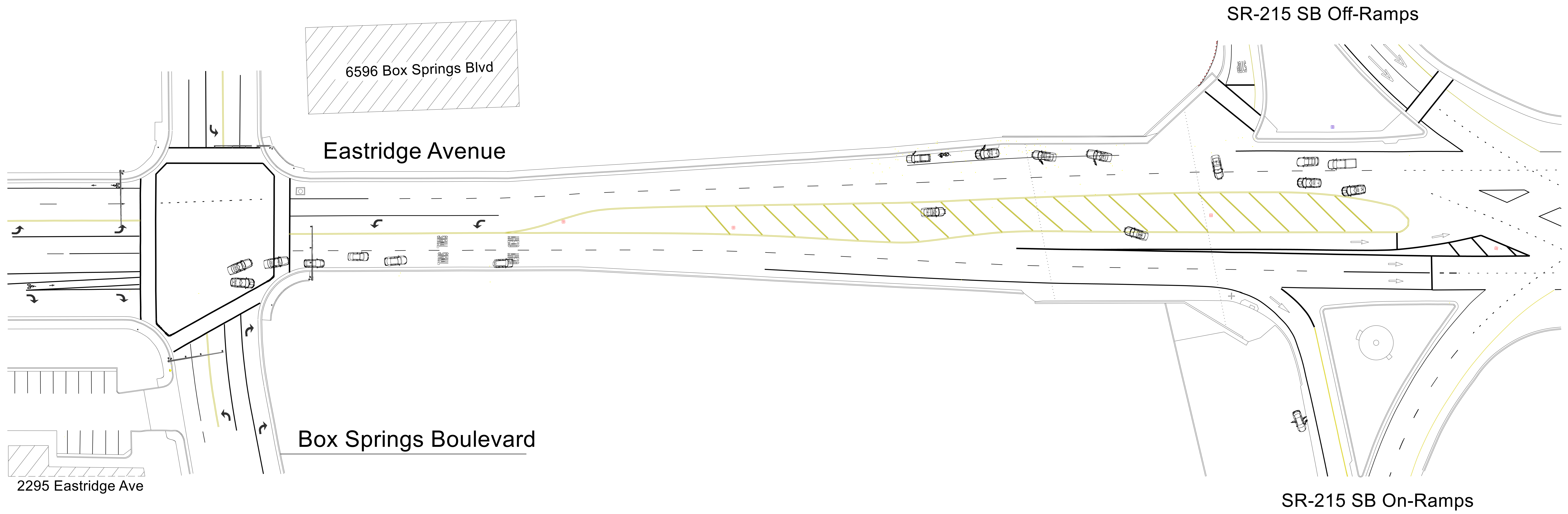

Case Number: 190023109
 Drawn By: Detective Greg Matthews
 Date: January 10, 2020
 Scale: 1" = 26.4' (ARCH E - 36x48)

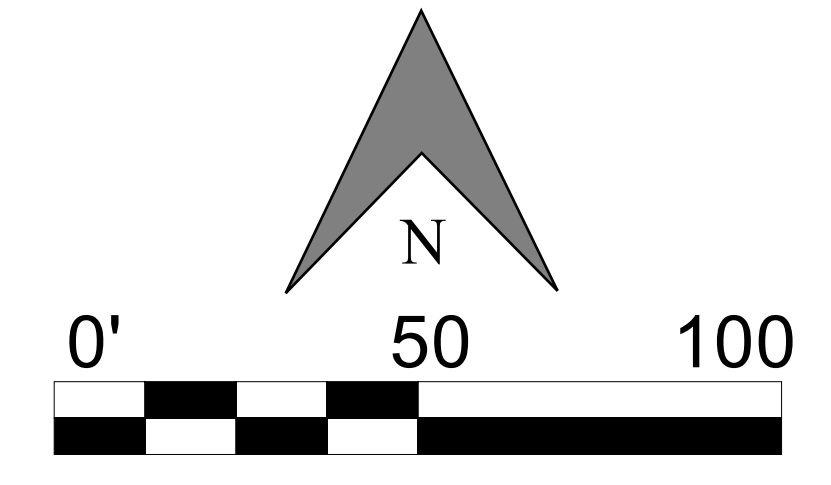

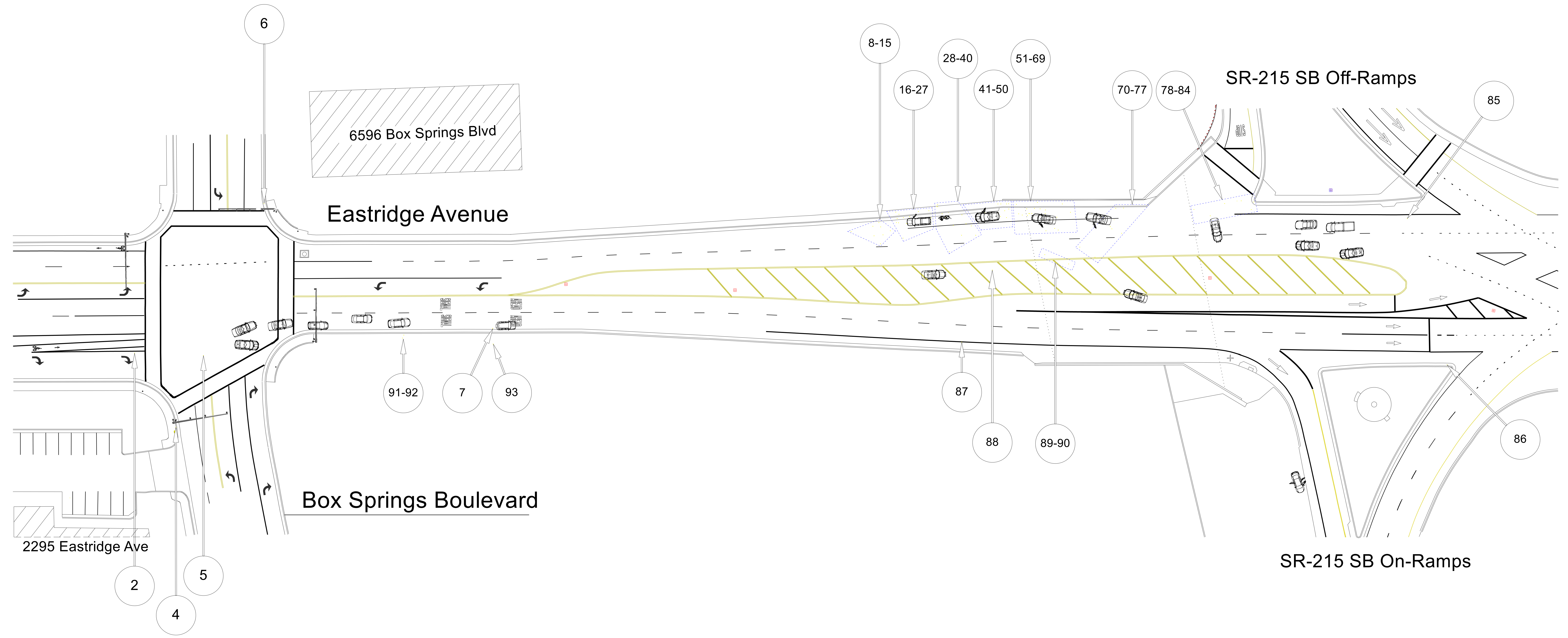

Case Number: 190023109
 Drawn By: Detective Greg Matthews
 Date: January 10, 2020
 Scale: 1" = 26.4' (ARCH E - 36x48)

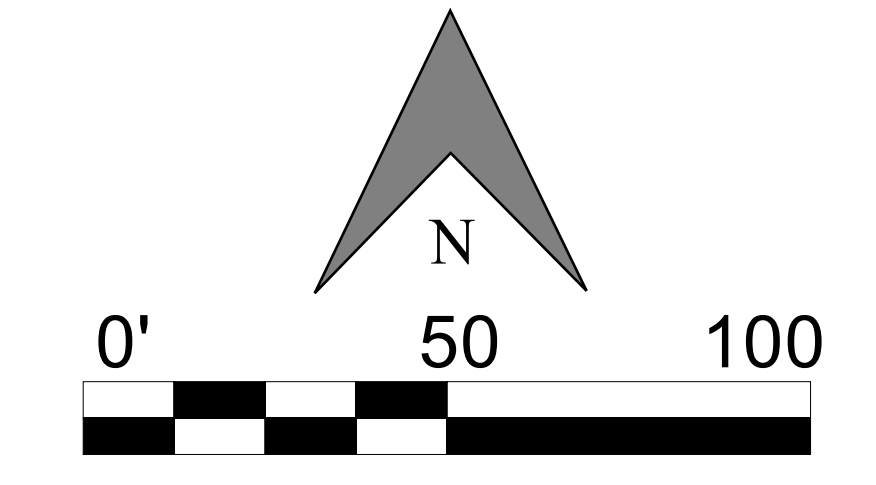



Riverside Police Department



tRIV01hoV

190023109
OV022C-B

Category : CASH - CURRENCY/STOCKS/BONDS
Description : 6 x .25 1 x .10 1 x .05 1 x .01
= \$1.66

Value : \$1.66

Serial Number :

Owner :

Date Collected: 08/14/2019 00:14

Reason Held : Evidence

Col Location : Eastridge, East Of Box Springs-
On Street Near White GMC Truck

Separated from OV022C

Collecting Officer : [REDACTED]
Offense Date : 08/12/2019
Offense Code : 187

Submitting Officer / ID

Date/Time

Deposited on 11/15/19
Oct 19 17

190023109

RIVERSIDE POLICE DEPARTMENT

CURRENCY ENVELOPE

Evidence Found Property Subsequent

REPORT # 10000009 ITEM # 0V022C-B

OWNER _____

SUSPECT _____

CRIME: 107 PC

LOCATION FOUND: FRONT 0V022C

FOUND BY: L. VEAN #1723 DATE/TIME FOUND: 8/14/19 @ 0014

CURRENCY:

~~_____ X \$100 = \$ _____~~
~~_____ X \$ 50 = \$ _____~~
~~_____ X \$ 20 = \$ _____~~
~~_____ X \$ 10 = \$ _____~~
~~_____ X \$ 5 = \$ _____~~
~~_____ X \$ 1 = \$ _____~~

Subtotal = \$ _____

_____ X \$1.00 = \$ _____
 _____ X \$0.50 = \$ _____
 _____ X \$0.25 = \$ 1.50 ✓
 _____ X \$0.10 = \$ 1.10 ✓
 _____ X \$0.05 = \$ 0.15 ✓
 _____ X \$0.01 = \$ 0.01 ✓

Subtotal = \$ 1.66 ✓

TOTAL AMOUNT: \$ 1.66

ENTERED & SEALED BY: L. VEAN #1723 ave.

DATE/TIME: 8/15/19 @ 1928 VERIFIED BY: D. [unclear] #1547

PROPERTY UNIT USE ONLY:

Received by: AB 1717 Date: 8/16/19 Intact? yes no

Opened by: 681917 Date: 11/02/19 Accurate: yes no

Resealed by: _____ Date: _____ Verified by: _____

EVIDENCE LOG

**KEY: POR= POINT OF REFERENCE, COLL. TIME = COLLECTION TIME, EVID. NUM = EVIDENCE
ITEM NUMBER**

EVIDENCE LOG

FILE: 190023109P.O.R # 1 – MOYE, ANDRE (DOB: 4-15-1985)DATE: 8-12-2019 / 8-13-2019P.O.R # 2 – PAUL, ROBERT (DOB: 10-1-1984)LOCATION: 26520 Cactus Ave. Moreno Valley 92555P.O.R # 3- LUTHER, AARON (DOB: 3-23-1970)TECHNICIAN: R. MEYER #1913

P.O.R # _____

EVID NUM	COLL TIME	DESCRIPTION OF EVIDENCE	POR	N	S	E	W	HT
		UNDER VICTIM, MOYE						
N/A	2157	BADGE, NAME PLATE, AND (2) GOLD PENS REMOVED FROM MOYE'S UNIFORM SHIRT (MOY018), RELEASED TO SGT SIMONS ON 8/14/19 @1556 HRS.	1					
MOY019	2157	WHITE UNDER-SHIRT, REMOVED FROM UNDER VICTIM, MOYE	1					
MOY020	2203	(2) MOTOR UNIFORM BOOTS, VICTIM, MOYE, RECEIVED FROM HOSPITAL STAFF	1					
MOY021	2206	FOLDING KNIFE, REMOVED FROM RIGHT BOOT (MOY020), VICTIM, MOYE	1					
MOY022	8/12/19 0028	(2) BLACK SOCKS, VICTIM, MOYE, RECEIVED FROM HOSPITAL STAFF	1					
MOY023	2143	BLACK BOXER BRIEFS AND SHIRT KEEPER, VICTIM, MOYE, RECEIVED FROM HOSPITAL	1					
MOY024	1542	SMITH AND WESSON M&P 40, SERIAL HYY59191, RECEIVED FROM CHP OFFICER SANDOVAL #21620	1					
MOY025	1542	40 CAL MAGAZINE, (LOADED/15 ROUNDS) AND (1) 40 CALIBER ROUND FROM CHAMBER (MOY024)	1					
MOY026	2143	(2) 40 CAL MAGAZINE, (EACH LOADED/15 ROUNDS) FROM DUTY BELT (MOY013)	1					
MOY027	2157	(2) EYE DROPS, LIP BALM, AND JR. BADGE STICKERS REMOVED FROM UNIFORM SHIRT POCKETS (MOY018)	1					
PAUL01	2253	UNIFORM PANTS WITH VELCROW BELT, RECEIVED FROM HOSPITAL STAFF, VICTIM PAUL	2					
PAUL02	2258	FOLDING KNIFE, REMOVED FROM REAR PANT POCKET (PAUL01)	2					
PAUL03	2259	(2) BLACK GLOVES, REMOVED FROM REAR PANT POCKET (PAUL01)	2					
PAUL04	2305	DUTY VEST, RECEIVED FROM	2					

EVIDENCE LOG

FILE: 190023109

P.O.R # 1 – MOYE, ANDRE (DOB: 4-15-1985)

DATE: 8-12-2019 / 8-13-2019

P.O.R # 2 – PAUL, ROBERT (DOB: 10-1-1984)

LOCATION: 26520 Cactus Ave. Moreno Valley 92555

P.O.R # 3- LUTHER, AARON (DOB: 3-23-1970)

TECHNICIAN: R. MEYER #1913

P.O.R # _____

EVID NUM	COLL TIME	DESCRIPTION OF EVIDENCE	POR	N	S	E	W	HT
		HOSPITAL STAFF, VICTIM, PAUL						
PAUL05	2305	UNIFORM SHIRT, RECEIVED FROM HOSPITAL STAFF, VICTIM PAUL	2					
PAUL06	2305	WHITE UNDERSHIRT, RECEIVED FROM HOSPITAL STAFF, VICTIM PAUL	2					
PAUL07	2309	(2) BLACK DUTY BOOTS, RECEIVED FROM HOSPITAL STAFF, VICTIM PAUL	2					
PAUL08	2253	(4) LATEX GLOVES, REMOVED FROM LEFT PANT POCKET (PAUL01), VICTIM, PAUL	2					
PAUL09	2305	CHP BADGE, NAME PLATE, AND FLAG PIN, REMOVED FROM UNIFORM SHIRT (PAUL05), VICTIM, PAUL	2					
PAUL10	2305	(2) SHIRT KEEPERS, (2) KEYS, NOTEBOOK, AND PENCIL REMOVED FROM UNIFORM SHIRT (PAUL05), VICTIM, PAUL	2					
PAUL11	2325	DUTY BELT, WITH TASOR, AND HT, RECEIVED FROM CHP OFFICER SANDOVAL #2162, VICTIM, PAUL	2					
PAUL12	2325	WATCH, RECEIVED FROM HOSPITAL STAFF, VICTIM, PAUL	2					
PAUL13	2309	(2) BLACK SOCKS, RECEIVED FROM HOSPITAL STAFF, VICTIM, PAUL	2					
N/A		WALLET FROM LEFT REAR PANT POCKET (PAUL01), RELEASED TO SGT. SIMONS 8/14/19 @1645	2					
LUTH04	2350	(2) BUCCAL SAMPLES FROM SUSPECT, LUTHER	3					
LUTH05	8/13/19 0000	WALLET, RECEIVED FROM HOSPITAL STAFF, SUSPECT, LUTHER	3					
LUTH06	0003	HANDCUFFS REMOVED FROM WRISTS OF SUSPECT, LUTHER	3					
LUTH07	0019	GSR KIT FROM HANDS OF SUSPECT, LUTHER, RECIVED FROM DEPUTY CORONER BAKER	3					
LUTH08	0017	POSSIBLE DNA SWABS FROM PALM	3					

EVIDENCE LOG

FILE: 190023109

P.O.R # 1 – MOYE, ANDRE (DOB: 4-15-1985)

DATE: 8-12-2019 / 8-13-2019

P.O.R # 2 – PAUL, ROBERT (DOB: 10-1-1984)

LOCATION: 26520 Cactus Ave. Moreno Valley 92555

P.O.R # 3- LUTHER, AARON (DOB: 3-23-1970)

TECHNICIAN: R. MEYER #1913

P.O.R # _____

EVID NUM	COLL TIME	DESCRIPTION OF EVIDENCE	POR	N	S	E	W	HT
		AND BACKSIDE OF RIGHT HAND, SUSPECT, LUTHER						
LUTH09	00017	POSSIBLE DNA SWABS FROM PALM AND BACKSIDE OF LEFT HAND, SUSPECT, LUTHER,	3					
LUTH10	0050	BLACK SHIRT (HANES 2XL), REMOVED FROM UNDER SUSPECT, LUTHER	3					
LUTH11	0050	BOXER BRIEFS, BLUE AND BLACK STRIPE, FRUIT OF THE LOOM, REMOVED FROM SUSPECT, LUTHER	3					

EVIDENCE LOG

FILE: 190023109

DATE: 8/13/19

LOCATION: Eastridge Ave. / Box Springs Blvd.

SPECIALIST: [REDACTED]

P.O.R. # 2: Eastridge Ave. / Box Springs Blvd.

P.O.R. #

P.O.R. #

P.O.R. #

P.O.R. #

P.O.R. #

EVID NUM	COLL TIME	DESCRIPTION OF EVIDENCE	POR	LOCATION WHERE ITEM WAS COLLECTED
OV002	2114	(1) "Speer 223 REM" cartridge	2	From street
OV003	2107	(1) Metal projectile	2	From street
OV004	2122	(1) Metal fragment	2	From sidewalk
OV005	2126	(1) Metal jacketed projectile	2	From street
OV006	2131	(1) Metal jacketed projectile	2	From street
OV007	2211	(1) "WMA 16" cartridge case	2	From street near white Jeep 5VEX605/CA
OV008	2308	(1) Gray tow strap	2	From street
OV009	2310	(1) "REM 223 FC" cartridge case	2	From street
OV010	2311	(1) "REM 223 FC" cartridge case	2	From street
OV011	2313	(1) Orange S/S "Russell" training fit t-shirt, size 2XL; debris marks, holes	2	From street
OV012	2315	(6) "REM 223 FC" cartridge cases	2	From street
OV013	2316	(2) "REM 223 FC" cartridge cases	2	From street
OV014	2334	(9) "REM 223 FC" cartridge cases	2	From street
OV015	2340	(7) "REM 223 FC" cartridge cases	2	From street near white GMC truck 6Z11833/CA
OV016	0007	Black unk make and caliber semi-auto assault rifle, unk model/serial number	2	From sidewalk near white GMC truck 6Z11833/CA
OV016A	0007	(2) Empty blk 5.56 caliber magazines taped together w/ blk electrical tape	-	Separated from OV016
OV017	2343	(1) Gray tow strap	2	From street near white GMC truck 6Z11833/CA
OV018	2343	(1) Pair of grey shorts w/ bro belt; (2) lighters/charger; (2) brow/tan striped socks; (1) "Camel" cigarette box	2	From street near white GMC truck 6Z11833/CA
OV018A	2343	(1) Pair of blk/white "Puma" tennis shoes, size 11.5; Possible blood	2	Separated from OV018
OV018B	2343	Multiple keys	2	From front left pocket of shorts; Separated from OV018
OV019	2347	(1) Orange "OccuNomix" L/S t-shirt w/ silver reflectors, size XL; Poss. blood	2	From street near white GMC truck 6Z11833/CA

KEY: POR= POINT OF REFERENCE, COLL. TIME = COLLECTION TIME, EVID. NUM = EVIDENCE ITEM NUMBER

EVIDENCE LOG

OV020	2349	(2) Empty black 5.56 caliber magazines taped together w/ blk electrical tape	2	From street near white GMC truck 6Z11833/CA
OV021	2358	(50) "REM 223 FC" cartridge cases	2	From street near white GMC truck 6Z11833/CA
VID01	0617	(3 DVD's) Master copy DVD of scene (do not release)	2	N/A
VID02	0830	(2 DVD's) Working copy DVD of scene (created: 8/29/19)	-	N/A

**KEY: POR= POINT OF REFERENCE, COLL. TIME = COLLECTION TIME, EVID. NUM = EVIDENCE
ITEM NUMBER**

EVIDENCE LOG

FILE: <u>190023109</u>	P.O.R. # 7: 6596 BOX SPRINGS BOULEVARD
DATE: <u>8/13/2019</u>	P.O.R. # 8: RPD UNIT #3849
LOCATION: <u>6596 BOX SPRINGS BOULEVARD</u>	P.O.R. #
SPECIALIST: [REDACTED]	P.O.R. #
	P.O.R. #

EVID NUM	COLL TIME	DESCRIPTION OF EVIDENCE	POR	LOCATION OF EVIDENCE
BM01	1111	POSSIBLE PROJECTILE (POSSIBLE LEAD)	7	PARKING LOT NORTH OF VISION HEATING AND AIR CONDITIONING GATED REAR LOT
BM02	1113	JACKETED PROJECTILE (POSSIBLE COPPER AND LEAD)	7	PARKING LOT NORTH OF VISION HEATING AND AIR CONDITIONING GATED REAR LOT
BM03	1115	JACKETED PROJECTILE (POSSIBLE COPPER AND LEAD)	7	PARKING LOT NORTH OF VISION HEATING AND AIR CONDITIONING GATED REAR LOT
BM04	1330	SCRAPING OF POSSIBLE PROJECTILE STRIKE	7	STRIKE MARK "BM-A4" ON EXTERIOR EAST SIDE OF BUILDING
KF01	1222	"COLT" 5.56 MM RIFLE, MODEL LAW ENFORCEMENT, SERIAL #LE066024 WITH STRAP, ATTACHED TLR-1 HL "STREAMLIGHT", AND ATTACHED SCOPE	8	FIREARM FOR RPD OFFICER KEVIN FEIMER- REMOVED FROM TRUNK OF RPD UNIT #3849
KF01-A	1222	"WMA 16" 5.56 MM CARTRIDGE (LIVE)	-	FROM CHAMBER OF ITEM #KF01
KF01-B	1222	RIFLE MAGAZINE AND (16) "WMA 16" 5.56 MM CARTRIDGES (LIVE)	-	REMOVED FROM ITEM #KF01
BM-A	PHOTO	POSSIBLE STRIKE MARK	7	E-ZHAULER TRAILER (CA PERM TRAILER #4RR5175) EXTERIOR EAST WALL
BM-A1	PHOTO	POSSIBLE STRIKE MARK	7	E-ZHAULER TRAILER (CA PERM TRAILER #4RR5175) INTERIOR EAST WALL
BM-A2	PHOTO	POSSIBLE STRIKE MARK	7	E-ZHAULER TRAILER (CA PERM TRAILER #4RR5175) INTERIOR WEST WALL
BM-A3	PHOTO	POSSIBLE STRIKE MARK	7	E-ZHAULER TRAILER (CA PERM TRAILER #4RR5175) EXTERIOR WEST WALL

**KEY: POR= POINT OF REFERENCE, N = NORTH, S = SOUTH, E = EAST, W = WEST, HT = HEIGHT
COLL. TIME = COLLECTION TIME, EVID. NUM= EVIDENCE ITEM NUMBER**

EVIDENCE LOG

EVID NUM	COLL TIME	DESCRIPTION OF EVIDENCE	POR	LOCATION OF EVIDENCE
BM-A4	PHOTO	POSSIBLE STRIKE MARK	7	EXTERIOR EAST SIDE OF BUILDING NEAR BOTTOM
BM-B	PHOTO	POSSIBLE STRIKE MARK	7	EXTERIOR EAST SIDE OF BUILDING NEAR TOP
BM-C	PHOTO	POSSIBLE STRIKE MARK	7	EXTERIOR EAST SIDE OF BUILDING NEAR TOP
BM-D	PHOTO	POSSIBLE STRIKE MARK	7	EXTERIOR EAST SIDE OF BUILDING NEAR TOP
		BM = [REDACTED]		
		KF = KEVIN FEIMER		

**KEY: POR= POINT OF REFERENCE, N = NORTH, S = SOUTH, E = EAST, W = WEST, HT = HEIGHT
COLL. TIME = COLLECTION TIME, EVID. NUM= EVIDENCE ITEM NUMBER**

EVIDENCE LOG

P.O.R. # 1: White Kia Optima 7MYW037/CA

FILE: 190023109

P.O.R. #

DATE: 8/21/19

P.O.R. #

LOCATION: Magnolia Station

P.O.R. #

SPECIALIST:

P.O.R. #

P.O.R. #

EVID NUM	COLL TIME	DESCRIPTION OF EVIDENCE	POR	LOCATION WHERE ITEM WAS COLLECTED
KIA01	0947	(1) Control and (1) sample swab of possible blood	1	Exterior front driver door frame
KIA02	0950	(1) Control and (1) sample swab of possible blood	1	Exterior rear driver door (below handle)
KIA03	0951	(1) Control and (1) sample swab of possible blood	1	Interior front driver door frame
KIA04	0953	(1) Control and (1) sample swab of possible blood	1	Gear shift base frame (driver side)
KIA05	1003	Metal fragment	1	Interior rear driver floorboard (under floor mat)
KIA06	0954	(1) Sample swab of sterile collection water	-	N/A
		<u>Possible Strike Marks</u>		
A	-	Possible strike mark	1	Exterior side of windshield near front passenger side
A1	-	Possible strike mark	1	Interior side of windshield near front passenger side
A2	-	Possible strike mark	1	Interior headliner near front passenger side
A3	-	Possible strike mark	1	Interior headliner near front passenger side
A4	-	Possible strike mark	1	Interior headliner near front passenger side
B	-	Possible strike mark	1	Interior front passenger visor
C	-	Possible strike mark	1	Interior front passenger visor
D	-	Possible strike mark	1	Interior front passenger visor
E	-	Possible strike mark	1	Interior front passenger visor
F	-	Possible strike mark	1	Exterior rear driver door window frame

KEY: POR= POINT OF REFERENCE, COLL. TIME = COLLECTION TIME, EVID. NUM = EVIDENCE ITEM NUMBER

EVIDENCE LOG

FILE: 190023109

DATE: 8/13/19

LOCATION: CHP Lincoln Station

SPECIALIST: [REDACTED]

P.O.R. # 1: CHP Ofc. [REDACTED]

P.O.R. # 2: CHP Ofc. [REDACTED]

P.O.R. #

P.O.R. #

P.O.R. #

P.O.R. #

EVID NUM	COLL TIME	DESCRIPTION OF EVIDENCE	POR	LOCATION WHERE ITEM WAS COLLECTED
SMI01	0140	(1) Pair of beige "United Uniform" CHP pants; (2) black gloves from rear left pocket of pants- Poss. blood, debris marks, and holes	1	Received from [REDACTED]
SMI02	0119	Black Smith and Wesson .40 cal semi-auto pistol model M&P 40 (serial #JBV8354)	1	Received from [REDACTED]
SMI02A	0119	(1) Black magazine; (15) "Federal 40 S&W" cartridges	1	Separated from SMI02
SMI02B	0119	(2) Black magazines from duty belt; (7) "Federal 40 S&W" cartridges; (5) "Federal 40 S&W" cartridges (separated from the magazines)	1	Received from [REDACTED]
SMI02C	0119	(1) "Federal 40 S&W" cartridge	1	From firearm chamber (separated from SMI02)
KES01	0153	(1) Beige "Frontline Call of Duty" L/S CHP uniform shirt, size 15/33; (1) Pair of beige "Flying Cross" CHP uniform pants- Poss. blood and debris marks	2	Received from CHP personnel

KEY: POR= POINT OF REFERENCE, COLL. TIME = COLLECTION TIME, EVID. NUM = EVIDENCE ITEM NUMBER

EVIDENCE LOG

FILE: 190023109

DATE: 8/14/19

LOCATION: Eastridge Ave. / Box Springs Blvd.

SPECIALIST: [REDACTED]

P.O.R. # 2: Eastridge Ave. / Box Springs Blvd.

P.O.R. #

P.O.R. #

P.O.R. #

P.O.R. #

P.O.R. #

EVID NUM	COLL TIME	DESCRIPTION OF EVIDENCE	POR	LOCATION WHERE ITEM WAS COLLECTED
OV022A	0002	(1) Navy blue "King Sportswear" hooded L/S sweatshirt, size 2XL	2	From street near white GMC truck 6Z11833/CA
OV022B	0002	(1) Blue/silver "Tac-Force" knife; possible blood	2	From street near white GMC truck 6Z11833/CA
OV022B-A	0002	(1) Original envelope that held OV022B	-	Knife removed from original packaging and secured in gun box for safety purposes
OV022C	0014	(1) Multi-colored backpack w/misc. docs and tools; Possible blood and unk white powder/poss. paraphernalia exterior bottom pocket	2	From street near white GMC truck 6Z11833/CA
OV022C-A	0014	(1) Black 5.56 caliber magazine; (9) .223 cartridges from magazine	-	Separated from OV022C (inside backpack pocket)
OV022C-B	0014	6 x .25 1 x .10 1 x .05 1 x .01 = \$1.66	-	Separated from OV022C
OV023	0206	(1) Control and (1) sample swab of possible blood	2	From street near white GMC truck 6Z11833/CA
OV024	0017	(1) Silver "Coolpad" cell phone-possible blood	2	From street near white GMC truck 6Z11833/CA; Released to Det. J. Adcox on 8/15/19 at 1350 hours
OV025	0338	Misc. clothes, personal items, tools (previously removed from GMC truck)	2	From sidewalk near white GMC truck 6Z11833/CA; Released back to truck at scene per Det. J. Ontko
OV026	0338	Multiple personal items and tools (previously removed from GMC truck)	2	From sidewalk near white GMC truck 6Z11833/CA; Released back to truck at scene per Det. J. Ontko
OV027	0021	(3) "REM 223 FC" cartridge cases	2	From street near white GMC truck 6Z11833/CA
OV028	0026	(1) Metal jacketed projectile	2	From sidewalk near CHP motorcycle 3006136/CA Exempt
OV029	0027	(1) Brown leather band w/ black face-cracked/brown, Apple Watch "Series 1"	2	From sidewalk near CHP motorcycle 3006136/CA Exempt
OV030	0217	Sample of possible blood on brush (twigs)	2	Near sidewalk and CHP motorcycle 3006136/CA Exempt
OV031	0028	(1) Black pair of broken "Oakley" sunglasses; Possible blood	2	From street near CHP motorcycle 3006136/CA Exempt
OV032	0030	(1) "REM 223 FC" cartridge case	2	From street near CHP motorcycle 3006136/CA Exempt
OV033A	0030	(1) Black electronic device	2	On top of CHP motorcycle 3006136/CA Exempt
OV033B	0030	(1) Yellow taser w/ labels "Moye" and "840-34", serial #X30004135	2	On top of CHP motorcycle 3006136/CA Exempt

KEY: POR= POINT OF REFERENCE, COLL. TIME = COLLECTION TIME, EVID. NUM = EVIDENCE ITEM NUMBER

EVIDENCE LOG

OV033C	0030	(2) Dark tan/black riding gloves	2	On top of CHP motorcycle 3006136/CA Exempt
OV034	0033	(3) "REM 223 FC" cartridge cases	2	From street near CHP motorcycle 3006136/CA Exempt
OV035	0035	(12) "REM 223 FC" cartridge cases	2	From street btwn CHP motorcycle 3006136/CA Exempt and CHP vehicle 1484455/ CA Exempt
OV036	0035	(3) "REM 223 FC" cartridge cases	2	From street near CHP vehicle 1484455/CA Exempt
OV037	0036	(4) "REM 223 FC" cartridge cases	2	From street near CHP vehicle 1484455/CA Exempt
OV038	0038	(12) "REM 223 FC" cartridge cases	2	From street near CHP vehicle 1484455/CA Exempt
OV039	0040	(6) "REM 223 FC" cartridge cases	2	From street near CHP vehicle 1484455/CA Exempt
OV040	0041	(1) Metal jacket	2	From street
OV041	0051	(4) "Federal 40 S&W" cartridge cases	2	From street near CHP vehicle 1484455/CA Exempt
OV042	0051	(1) Metal jacketed projectile	2	From street near CHP vehicle 1484455/CA Exempt
OV043	0052	(1) "Federal 40 S&W" cartridge case and metal fragment	2	From street near CHP vehicle 1484455/CA
OV044	0054	(1) Metal jacket fragment	2	From street near CHP vehicle 1484455/CA
OV045	0055	(1) Metal projectile	2	From sidewalk near CHP vehicle 1484455/CA Exempt
OV046	0057	(1) Metal projectile	2	From sidewalk near CHP vehicle 1484455/CA Exempt
OV048	0058	(4) "Federal 40 S&W" cartridge cases	2	From sidewalk near CHP vehicle 1484455/CA Exempt
OV049	0058	(3) "Federal 40 S&W" cartridge cases	2	From street near CHP vehicle 1484455/CA Exempt
OV050	0102	(1) Metal jacket fragment	2	From sidewalk near CHP vehicle 1484455/CA Exempt
OV051	0109	(5) "Federal 40 S&W" cartridge cases	2	From sidewalk between CHP vehicles 1484455/CA Exempt and 1484560/CA Exempt
OV052	0111	(1) "Federal 40 S&W" cartridge case	2	From street near CHP vehicle 1484560/CA Exempt
OV054	0120	(3) "Federal 40 S&W" cartridge cases	2	From street near CHP vehicle 1484560/CA Exempt
OV055	0219	(1) Control and (1) sample swab of possible blood	2	From street near CHP vehicle 1484560/CA Exempt

KEY: POR= POINT OF REFERENCE, COLL. TIME = COLLECTION TIME, EVID. NUM = EVIDENCE ITEM NUMBER

EVIDENCE LOG

FILE: <u>190023109</u>	P.O.R. # 1: RIVERSIDE SHERIFF DEPUTY [REDACTED]
DATE: <u>8/12/2019</u>	P.O.R. # 2: RIVERSIDE SHERIFF DEPUTY [REDACTED]
LOCATION: <u>MORENO VALLEY POLICE STATION</u>	P.O.R. # 3: RIVERSIDE SHERIFF DEPUTY [REDACTED]
SPECIALIST: <u>[REDACTED]</u>	P.O.R. # 4: RIVERSIDE SHERIFF DEPUTY [REDACTED]
	P.O.R. # 5: RIVERSIDE SHERIFF DEPUTY [REDACTED]

EVID NUM	COLL TIME	DESCRIPTION OF EVIDENCE	POR	LOCATION OF EVIDENCE
MCHAP01	2155	(1) CONTROL & (1) SAMPLE SWAB OF POSSIBLE BLOOD	1	RIGHT PALM
MCHAP02	2158	(1) CONTROL & (1) SAMPLE SWAB OF POSSIBLE BLOOD	1	LEFT PALM
MCHAP03	2201	(2) BUCCAL DNA EXEMPLAR SWABS	1	MOUTH
JV01	2236	(1) CONTROL & (1) SAMPLE SWAB OF POSSIBLE BLOOD	2	RIGHT FOREARM
JV02	2238	(2) BUCCAL DNA EXEMPLAR SWABS	2	MOUTH
WS-1	2251	(1) SAMPLE SWAB OF STERILE COLLECTION WATER	-	FOR MORENO VALLEY PD SAMPLES BEFORE 2251 HOURS
BE01	2315	(1) CONTROL & (1) SAMPLE SWAB OF POSSIBLE BLOOD	3	RIGHT RING FINGER
BE02	2318	(1) CONTROL & (1) SAMPLE SWAB OF POSSIBLE BLOOD	3	LEFT UNIFORM SHIRT POCKET
BE03	2320	(1) CONTROL & (1) SAMPLE SWAB OF POSSIBLE BLOOD	3	RIGHT BOOT TOE LEATHER UPPER
BE04	2335	"GLOCK" 9MM SEMI-AUTO PISTOL, MODEL 17, SERIAL #WSM804 BLACK, ATTACHED TLR-1 HL "STREAMLIGHT"	3	RIGHT HIP HOLSTER
BE04-A	2335	(1) "WIN 9MM LUGER" CARTRIDGE (LIVE)	-	FROM CHAMBER OF ITEM #BE04
BE04-B	2335	PISTOL MAGAZINE AND (15) "WIN 9MM LUGER" CARTRIDGES (LIVE) WITH POSSIBLE BLOOD	-	REMOVED FROM ITEM #BE04
-	-	-	-	-
-	-	-	-	-

**KEY: POR= POINT OF REFERENCE, N = NORTH, S = SOUTH, E = EAST, W = WEST, HT = HEIGHT
COLL. TIME = COLLECTION TIME, EVID. NUM= EVIDENCE ITEM NUMBER**

EVIDENCE LOG

FILE: 190023109P.O.R # 1 - MOYE, ANDRE (DOB: 4-15-1985)DATE: 8-12-2019 / 8-13-2019P.O.R # [REDACTED]LOCATION: 26520 Cactus Ave. Moreno Valley 92555P.O.R # 3- LUTHER, AARON (DOB: 3-23-1970)TECHNICIAN: [REDACTED]P.O.R # [REDACTED]

EVID NUM	COLL TIME	DESCRIPTION OF EVIDENCE	POR	N	S	E	W	HT
		UNDER VICTIM, MOYE						
N/A	2157	BADGE, NAME PLATE, AND (2) GOLD PENS REMOVED FROM MOYE'S UNIFORM SHIRT (MOY018), RELEASED TO SGT S [REDACTED] ON 8/14/19 @1556 HRS.	1					
MOY019	2157	WHITE UNDER-SHIRT, REMOVED FROM UNDER VICTIM, MOYE	1					
MOY020	2203	(2) MOTOR UNIFORM BOOTS, VICTIM, MOYE, RECEIVED FROM HOSPITAL STAFF	1					
MOY021	2206	FOLDING KNIFE, REMOVED FROM RIGHT BOOT (MOY020), VICTIM, MOYE	1					
MOY022	8/12/19 0028	(2) BLACK SOCKS, VICTIM, MOYE, RECEIVED FROM HOSPITAL STAFF	1					
MOY023	2143	BLACK BOXER BRIEFS AND SHIRT KEEPER, VICTIM, MOYE, RECEIVED FROM HOSPITAL	1					
MOY024	1542	SMITH AND WESSON M&P 40, SERIAL HYY59191, RECEIVED FROM CHP OFFICER [REDACTED]	1					
MOY025	1542	40 CAL MAGAZINE, (LOADED/15 ROUNDS) AND (1) 40 CALIBER ROUND FROM CHAMBER (MOY024)	1					
MOY026	2143	(2) 40 CAL MAGAZINE, (EACH LOADED/15 ROUNDS) FROM DUTY BELT (MOY013)	1					
MOY027	2157	(2) EYE DROPS, LIP BALM, AND JR. BADGE STICKERS REMOVED FROM UNIFORM SHIRT POCKETS (MOY018)	1					
[REDACTED]01	2253	UNIFORM PANTS WITH VELCROW BELT, RECEIVED FROM HOSPITAL STAFF, VICTIM [REDACTED]	2					
[REDACTED]02	2258	FOLDING KNIFE, REMOVED FROM REAR PANT POCKET ([REDACTED]01)	2					
[REDACTED]03	2259	(2) BLACK GLOVES, REMOVED FROM REAR PANT POCKET (PAUL01)	2					
[REDACTED]04	2305	DUTY VEST, RECEIVED FROM	2					

EVIDENCE LOG

FILE: 190023109P.O.R # 1 – MOYE, ANDRE (DOB: 4-15-1985)DATE: 8-12-2019 / 8-13-2019P.O.R # ████████████████████LOCATION: 26520 Cactus Ave. Moreno Valley 92555P.O.R # 3- LUTHER, AARON (DOB: 3-23-1970)TECHNICIAN: ████████████████████P.O.R # ████████████████████

EVID NUM	COLL TIME	DESCRIPTION OF EVIDENCE	POR	N	S	E	W	HT
		HOSPITAL STAFF, VICTIM, PAUL						
██████05	2305	UNIFORM SHIRT, RECEIVED FROM HOSPITAL STAFF, VICTIM ██████	2					
██████06	2305	WHITE UNDERSHIRT, RECEIVED FROM HOSPITAL STAFF, VICTIM ██████	2					
██████07	2309	(2) BLACK DUTY BOOTS, RECEIVED FROM HOSPITAL STAFF, VICTIM ██████	2					
██████08	2253	(4) LATEX GLOVES, REMOVED FROM LEFT PANT POCKET (██████01), VICTIM, ██████	2					
██████09	2305	CHP BADGE, NAME PLATE, AND FLAG PIN, REMOVED FROM UNIFORM SHIRT (██████05), VICTIM, ██████	2					
██████10	2305	(2) SHIRT KEEPERS, (2) KEYS, NOTEBOOK, AND PENCIL REMOVED FROM UNIFORM SHIRT (██████05), VICTIM, ██████	2					
██████11	2325	DUTY BELT, WITH TASOR, AND HT, RECEIVED FROM CHP OFFICER ██████, VICTIM, ██████	2					
██████12	2325	WATCH, RECEIVED FROM HOSPITAL STAFF, VICTIM, ██████	2					
██████13	2309	(2) BLACK SOCKS, RECEIVED FROM HOSPITAL STAFF, VICTIM, ██████	2					
N/A		WALLET FROM LEFT REAR PANT POCKET (PAUL01), RELEASED TO SGT. ██████ 8/14/19 @1645	2					
LUTH04	2350	(2) BUCCAL SAMPLES FROM SUSPECT, LUTHER	3					
LUTH05	8/13/19 0000	WALLET, RECEIVED FROM HOSPITAL STAFF, SUSPECT, LUTHER	3					
LUTH06	0003	HANDCUFFS REMOVED FROM WRISTS OF SUSPECT, LUTHER	3					
LUTH07	0019	GSR KIT FROM HANDS OF SUSPECT, LUTHER, RECIVED FROM DEPUTY CORONER ██████	3					
LUTH08	0017	POSSIBLE DNA SWABS FROM PALM	3					

EVIDENCE LOG

FILE: 190023109

P.O.R # 1 – MOYE, ANDRE (DOB: 4-15-1985)

DATE: 8-12-2019 / 8-13-2019

P.O.R # [REDACTED]

LOCATION: 26520 Cactus Ave. Moreno Valley 92555

P.O.R # 3- LUTHER, AARON (DOB: 3-23-1970)

TECHNICIAN: [REDACTED]

P.O.R # _____

EVID NUM	COLL TIME	DESCRIPTION OF EVIDENCE	POR	N	S	E	W	HT
		AND BACKSIDE OF RIGHT HAND, SUSPECT, LUTHER						
LUTH09	00017	POSSIBLE DNA SWABS FROM PALM AND BACKSIDE OF LEFT HAND, SUSPECT, LUTHER,	3					
LUTH10	0050	BLACK SHIRT (HANES 2XL), REMOVED FROM UNDER SUSPECT, LUTHER	3					
LUTH11	0050	BOXER BRIEFS, BLUE AND BLACK STRIPE, FRUIT OF THE LOOM, REMOVED FROM SUSPECT, LUTHER	3					

EVIDENCE LOG

FILE: 190023109DATE: 8/14/19LOCATION: Eastridge Ave. / Box Springs Blvd.SPECIALIST: [REDACTED]P.O.R. # 2: Eastridge Ave. / Box Springs Blvd.

P.O.R. #

P.O.R. #

P.O.R. #

P.O.R. #

P.O.R. #

EVID NUM	COLL TIME	DESCRIPTION OF EVIDENCE	POR	LOCATION WHERE ITEM WAS COLLECTED
OV056	0319	(1) Black .40 S&W magazine (empty)	2	From street near CHP vehicle 1484560/CA Exempt
OV059	0134	(12) "Federal 40 S&W" cartridge cases	2	From street near CHP vehicle 1484560/CA Exempt
OV060	0135	(27) "Federal 40 S&W" cartridge cases	2	From sidewalk near CHP vehicle 1484560/CA Exempt
OV061	0136	(1) Metal jacketed fragment	2	From street near CHP vehicle 1484560/CA Exempt
OV062	0137	(2) "Federal 40 S&W" cartridge cases	2	From street near CHP vehicle 1484560/CA Exempt
OV063	0222	(1) Control and (1) sample swab of possible blood	2	From street near CHP vehicle 1484560/CA Exempt
OV064	0139	(8) "Federal 40 S&W" cartridge cases; (1) "FC 18 40 S&W" cartridge case	2	From sidewalk near CHP vehicle 1484560/CA Exempt
OV065	0225	(1) Control and (1) sample swab of possible blood	2	From street near CHP vehicle 1484560/CA Exempt
OV066	0140	(1) Metal jacket fragment	2	From street near CHP vehicle 1484560/CA Exempt
OV067	0141	(1) Metal projectile	2	From street near CHP vehicle 1484560/CA Exempt
OV068	0142	(1) Pair of black broken sunglasses	2	From street near CHP vehicle 1484560/CA Exempt
OV069	0153	(9) "Federal 40 S&W" cartridge cases	2	From street near CHP vehicle 1484560/CA Exempt
OV070	0154	(1) Metal jacket fragment	2	From street
OV071	0156	(1) Metal projectile fragment	2	From street
OV072	0157	(1) Metal jacket fragment	2	From street near Moreno Valley PD (RSO) vehicle 1378955/CA Exempt
OV073	0158	(1) Pair of black/red "Ironman" sunglasses	2	From street near Moreno Valley PD (RSO) vehicle 1378955/CA Exempt
OV074	0200	(6) "WIN 9mm Luger" cartridge cases	2	From street near Moreno Valley PD (RSO) vehicle 1378955/CA Exempt
OV075	0200	(2) "WIN 9mm Luger" cartridge cases	2	From street near Moreno Valley PD (RSO) vehicle 1378955/CA Exempt
OV076	0201	(1) "WIN 9mm Luger" cartridge case	2	From street near Moreno Valley PD (RSO) vehicle 1378955/CA Exempt

KEY: POR= POINT OF REFERENCE, COLL. TIME = COLLECTION TIME, EVID. NUM = EVIDENCE ITEM NUMBER

EVIDENCE LOG

OV077	0202	(1) "WIN 9mm Luger" cartridge case	2	From street near Moreno Valley PD (RSO) vehicle 1378955/CA Exempt
OV078	0230	(2) "WIN 9mm Luger" cartridge cases	2	From street near CHP vehicle 1501485/CA Exempt
OV079	0230	(1) Metal jacket fragment	2	From street near CHP vehicle 1501485/CA Exempt
OV080	0231	(1) "Federal 40 S&W" cartridge case	2	From street near 215 Fwy exit ramp
OV081	0232	(1) Set of dark grey "Peerless Handcuff Co" handcuffs	2	From street near 215 Fwy exit ramp
OV082	0233	(1) Silver "Peerless Handcuff" handcuff key	2	From street near 215 Fwy exit ramp
OV083	0235	(1) "Federal 40 S&W" cartridge case	2	From street near 215 Fwy exit ramp
OV084	0237	(1) Control and (1) sample swab of possible blood	2	From street near 215 Fwy exit ramp
REA01	0238	(1) Sample swab of sterile collection water	2	N/A
OV085	0244	(1) "Speer 223 REM" cartridge	2	From street
OV086	0246	(5) "Speer 223 REM" cartridge cases	2	From street
OV087	0257	(1) Metal projectile fragment	2	From street
OV088	0253	(1) Metal jacket fragment	2	From street
OV089	0254	(1) Metal jacket fragment	2	From street
OV090	0256	(1) Metal projectile	2	From street
OV094	0259	(1) "Speer 223 REM" cartridge case	2	On exterior trunk of CHP vehicle 1501660/CA Exempt
OV095	0300	(1) "Speer 223 REM" cartridge case	2	On exterior trunk of CHP vehicle 1501660/CA Exempt
OV096	0301	(1) "Speer 223 REM" cartridge case	2	Inside of CHP vehicle 1501660/CA Exempt
OV097	0302	(1) "Speer 223 REM" cartridge case	2	Inside of CHP vehicle 1501660/CA Exempt
OV098	0303	(1) "Speer 223 REM" cartridge case	2	On exterior trunk of CHP vehicle 1501660/CA Exempt
OV100	0310	(1) Metal jacketed projectile and multiple metal projectile fragments and metal jacket fragments	2	From street between CHP vehicles 1484455/CA Exempt and 1484560/CA Exempt

KEY: POR= POINT OF REFERENCE, COLL. TIME = COLLECTION TIME, EVID. NUM = EVIDENCE ITEM NUMBER

EVIDENCE LOG

FILE: 190023109
 DATE: 8/22/19
 LOCATION: Magnolia Station
 SPECIALIST: [REDACTED]

P.O.R. # 1: B/W Ford Crown Victoria- Moreno Valley
 P.O.R. # Police (RSO) Unit- 1378955/CA Exempt
 P.O.R. # Unit: 11-246
 P.O.R. #
 P.O.R. #
 P.O.R. #

EVID NUM	COLL TIME	DESCRIPTION OF EVIDENCE	POR	LOCATION WHERE ITEM WAS COLLECTED
MOR01	0954	(1) Control and (1) sample swab of possible blood	1	Interior rear passenger seat
MOR02	1025	Metal fragment	1	Interior front driver door frame near poss. strike marks B and B1
MOR03	1121	Metal jacket and fragment	1	Interior front driver door panel (behind panel)
MOR04	1121	Metal fragments	1	Interior front driver door panel (behind panel)
MOR05	1234	Metal fragments	1	Interior front driver side of bumper (from poss. strike mark A1)
MOR06	0956	(1) Sample swab of sterile collection water	-	N/A
		<u>Possible Strike Marks</u>		
A	-	Possible strike mark	1	Front driver side of bumper
A1	-	Possible strike mark	1	Front driver side of bumper- interior side on metal frame
B	-	Possible strike mark	1	Interior front driver door (plastic cover)
B1	-	Possible strike mark	1	Interior front driver door frame
		<u>Collected on 8/21/19</u>		
MOR07	1513	Black Remington 12 GA pump action shotgun model 870 (serial #AB415310M) (#89 sticker)	1	Removed from shotgun locking rack between front driver and front passenger seats

KEY: POR= POINT OF REFERENCE, COLL. TIME = COLLECTION TIME, EVID. NUM = EVIDENCE ITEM NUMBER

STRIKE MARK LOG

N		POSSIBLE STRIKE MARK	1	EXTERIOR FRONT FENDER VENT, RIGHT SIDE
O		POSSIBLE STRIKE MARK	1	EXTERIOR FRONT, ABOVE CENTER GRILL
P		POSSIBLE STRIKE MARK	1	EXTERIOR FRONT, RIGHT OF RADIATOR
P1		POSSIBLE STRIKE MARK	1	INTERIOR SIDE OF RADIATOR
P2		POSSIBLE STRIKE MARK	1	INTERIOR PLASTIC FRONT GRILL FAN/COVER
Q		POSSIBLE STRIKE MARK (MAY BE A DRILL MARK)	1	EXTERIOR FRONT BUMPER GUARD
R		POSSIBLE STRIKE MARK	1	EXTERIOR, FRONT PASSENGER SIDE QUARTER PANEL
S		POSSIBLE STRIKE MARK	1	EXTERIOR, FRONT PASSENGER DOOR
T		POSSIBLE STRIKE MARK	1	EXTERIOR, FRONT PASSENGER DOOR
U		POSSIBLE STRIKE MARK	1	EXTERIOR, FRONT PASSENGER DOOR
V		POSSIBLE STRIKE MARK	1	EXTERIOR, FRONT PASSENGER DOOR
W		POSSIBLE STRIKE MARK	1	EXTERIOR, FRONT PASSENGER DOOR
X		POSSIBLE STRIKE MARK	1	EXTERIOR, FRONT PASSENGER DOOR FRAME, NEAR SPOTLIGHT
Y		POSSIBLE STRIKE MARK	1	EXTERIOR, FRONT PASSENGER WINDOW
Z		POSSIBLE STRIKE MARK	1	EXTERIOR, REAR WINDSHIELD
AA		POSSIBLE STRIKE MARK	1	INTERIOR, REAR PASSENGER HEADLINER, NEAR REAR BRAKE LIGHT
BB		POSSIBLE STRIKE MARK	1	INTERIOR, REAR PASSENGER HEADLINER, NEAR REAR BRAKE LIGHT
CC		POSSIBLE STRIKE MARK (Projectile, placard 9)	1	INTERIOR, BACK SIDE OF DRIVER HEAD-REST
DD		POSSIBLE STRIKR MARK (Projectile, placard 10)	1	INTERIOR, BACK SIDE OF DRIVER HEAD-REST
EE		POSSIBLE STRIKE MARK	1	INTERIOR, LEFT SIDE OF DRIVER SEAT
FF		POSSIBLE STRIKE MARK	1	INTERIOR, DRIVER SIDE SUN VISOR
FF1		POSSIBLE STRIKE MARK	1	INTERIOR, DRIVER SIDE SUN VISOR
GG		POSSIBLE STRIKE MARK	1	EXTERIOR, FRONT OF UNDER CARRIAGE OF VEHICLE

**KEY: POR= POINT OF REFERENCE, COLL. TIME = COLLECTION TIME, EVID. NUM = EVIDENCE
ITEM NUMBER**

STRIKE MARK LOG

GG1		POSSIBLE STRIKE MARK	1	EXTERIOR, FRONT OF UNDER CARRIAGE OF VEHICLE
HH		POSSIBLE STRIKE MARK	1	EXTERIOR, FRONT OF UNDER CARRIAGE OF VEHICLE
HH1		POSSIBLE STRIKE MARK	1	EXTERIOR, FRONT OF UNDER CARRIAGE OF VEHICLE
II		POSSIBLE STRIKE MARK	1	EXTERIOR, FRONT OF UNDER CARRIAGE OF VEHICLE
II1		POSSIBLE STRIKE MARK	1	EXTERIOR, FRONT OF UNDER CARRIAGE OF VEHICLE
JJ		POSSIBLE STRIKE MARK	1	EXTERIOR, FRONT GRILL
JJ1		POSSIBLE STRIKE MARK	1	INTERIOR OF FRONT GRILL
JJ2		POSSIBLE STRIKE MARK	1	INTERIOR FRONT PLASTC FAN/COVER
KK		POSSIBLE STRIKE MARK	1	EXTERIOR, FRONT OF UNDER CARRIAGE OF VEHICLE
LL		POSSIBLE STRIKE MARK	1	EXTERIOR, REAR OF UNDER CARRIAGE OF VEHICLE
MM		POSSIBLE STRIKE MARK	1	EXTERIOR, TIRE AXLE OF UNDERCARRIAGE
NN		POSSIBLE STRIKE MARK	1	EXTERIOR, INNER METAL TIRE WELL
OO		POSSIBLE STRIKE MARK (Fragment, placard 16)	1	EXTERIOR, INNER PLASTIC TIRE WELL LINER

**KEY: POR= POINT OF REFERENCE, COLL. TIME = COLLECTION TIME, EVID. NUM = EVIDENCE
ITEM NUMBER**

VEHICLE REPORT

CHP 180 (Rev. 4-16) OPI 061

REPORTING DEPARTMENT: **RIVERSIDE PD** LOCATION CODE: **3313** DATE / TIME OF REPORT: **0829/19/1045** NOTICE OF STORED VEHICLE DELIVERED PERSONALLY: FILE NO.: **190023109**

LOCATION TOWED / STOLEN FROM: **10540 MAGNOLIA UNK** ODOMETER READING: **UNK** VIN CLEAR IN SVS? YES NO DATE / TIME DISPATCH NOTIFIED: **083118** LOG NO.:

YEAR: **02** MAKE: **GMC** MODEL: **SANOMA** BODY TYPE: **PK** COLOR: **WHT** LICENSE NO.: **6Z11833** ONE MONTH / YEAR: TWO: STATE: **CA**

VEHICLE IDENTIFICATION NO.: **1GTCS19W328231712** ENGINE NO.: VALUATION BY: OFFICER OWNER **0-500** 1000+ 4001+ \$

REGISTERED OWNER: **AA [REDACTED]** SAME AS R/O: LEGAL OWNER: **[REDACTED]**

STORED IMPOUNDED RELEASED RECOVERED - VEHICLE / COMPONENT

TOWING / STORAGE CONCERN (NAME, ADDRESS, PHONE): **BAUMANS 9516838060** STORAGE AUTHORITY / REASON: **22695, SCUC**

REASON FOR STOP: **[REDACTED]** AIRBAG? YES NO 1 2 DRIVEABLE? YES NO JUNK UNK VIN SWITCHED? YES NO

CONDITION	YES	NO	ITEMS	YES	NO	ITEMS	YES	NO	ITEMS	YES	NO	TIRES / WHEELS	CONDITION
WRECKED			SEAT (FRONT)			REGISTRATION			CAMPER			LEFT FRONT	FAIR
BURNED HULK per 431(c) CVC			SEAT (REAR)			ALT. / GENERATOR			VESSEL AS LOAD			RIGHT FRONT	
VANDALIZED			RADIO			BATTERY			FIREARMS			LEFT REAR	
ENG. / TRANS. STRIP			TAPE DECK			DIFFERENTIAL			OTHER			RIGHT REAR	
MISC. PARTS STRIP			TAPES			TRANSMISSION						SPARE	
BODY METAL STRIP			OTHER RADIO			AUTOMATIC						HUB CAPS	
SURGICAL STRIP per 431(b) CVC			IGNITION KEY			MANUAL						SPECIAL WHEELS	
RELEASE VEHICLE TO:	<input type="checkbox"/> R/O OR AGENT	<input type="checkbox"/> AGENCY HOLD	<input type="checkbox"/> 22850.3 CVC										

GARAGE PRINCIPAL / AGENT STORING VEHICLE (SIGNATURE): **[REDACTED]** DATE / TIME: **0829/19/1343**

CERTIFICATION: I, THE UNDERSIGNED, DO HEREBY CERTIFY THAT I AM LEGALLY AUTHORIZED AND ENTITLED TO TAKE POSSESSION OF THE ABOVE DESCRIBED VEHICLE.

SIGNATURE OF PERSON AUTHORIZING RELEASE: **[REDACTED]** SIGNATURE OF PERSON TAKING POSSESSION: **[REDACTED]**

STOLEN VEHICLE / COMPONENT EMBEZZLED VEHICLE PLATE(S) REPORT

DATE / TIME OF OCCURRENCE: DATE / TIME REPORTED: NAME OF REPORTING PARTY (R/P): DRIVER LICENSE NO. / STATE:

LAST DRIVER OF VEHICLE: DATE / TIME: ADDRESS OF R/P: TELEPHONE OF R/P: ()

I CERTIFY OR DECLARE UNDER PENALTY OF PERJURY UNDER THE LAWS OF THE STATE OF CALIFORNIA THAT THE FOREGOING IS TRUE AND CORRECT.

REMARKS
(LIST PROPERTY, TOOLS, VEHICLE DAMAGE, ARRESTS)

DRIVER'S NAME: **body damage R/rear** ARRESTED / SECTION?: YES NO CARGO / TYPE?: **BIO-HAZARD** VALUE \$: **view mirror broken shell**

golf clubs, golf bag & balls, tool bag, tools, fire in bed

exterior body / parts damage (L / side view mirror broken shell)

FRONT LEFT SIDE RIGHT SIDE REAR TOP

SIGNATURE OF: **[REDACTED]** I.D. NO.: SUPERVISOR: REQUIRED NOTICES SENT TO REGISTERED AND LEGAL OWNERS PER 22852 CVC? YES NO DATE NOTIFIED: **090319**

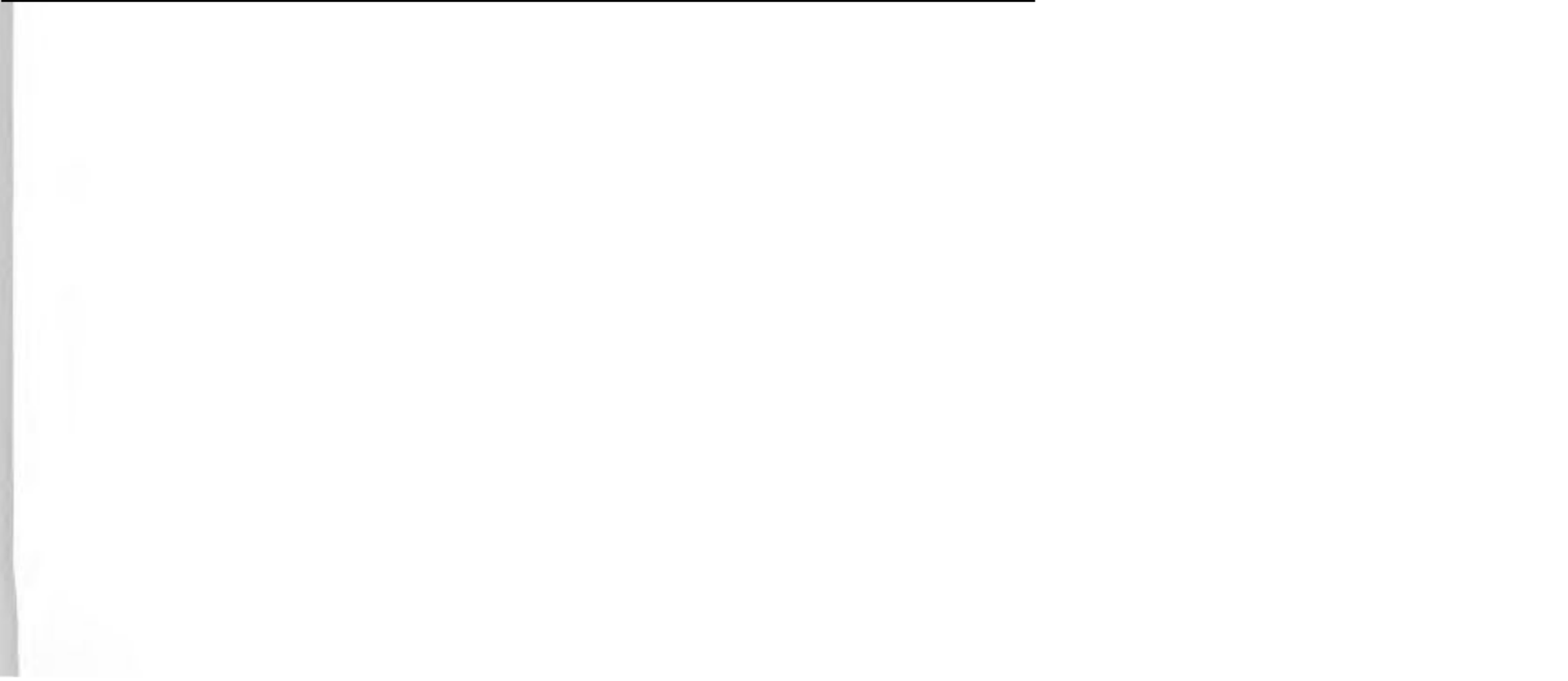
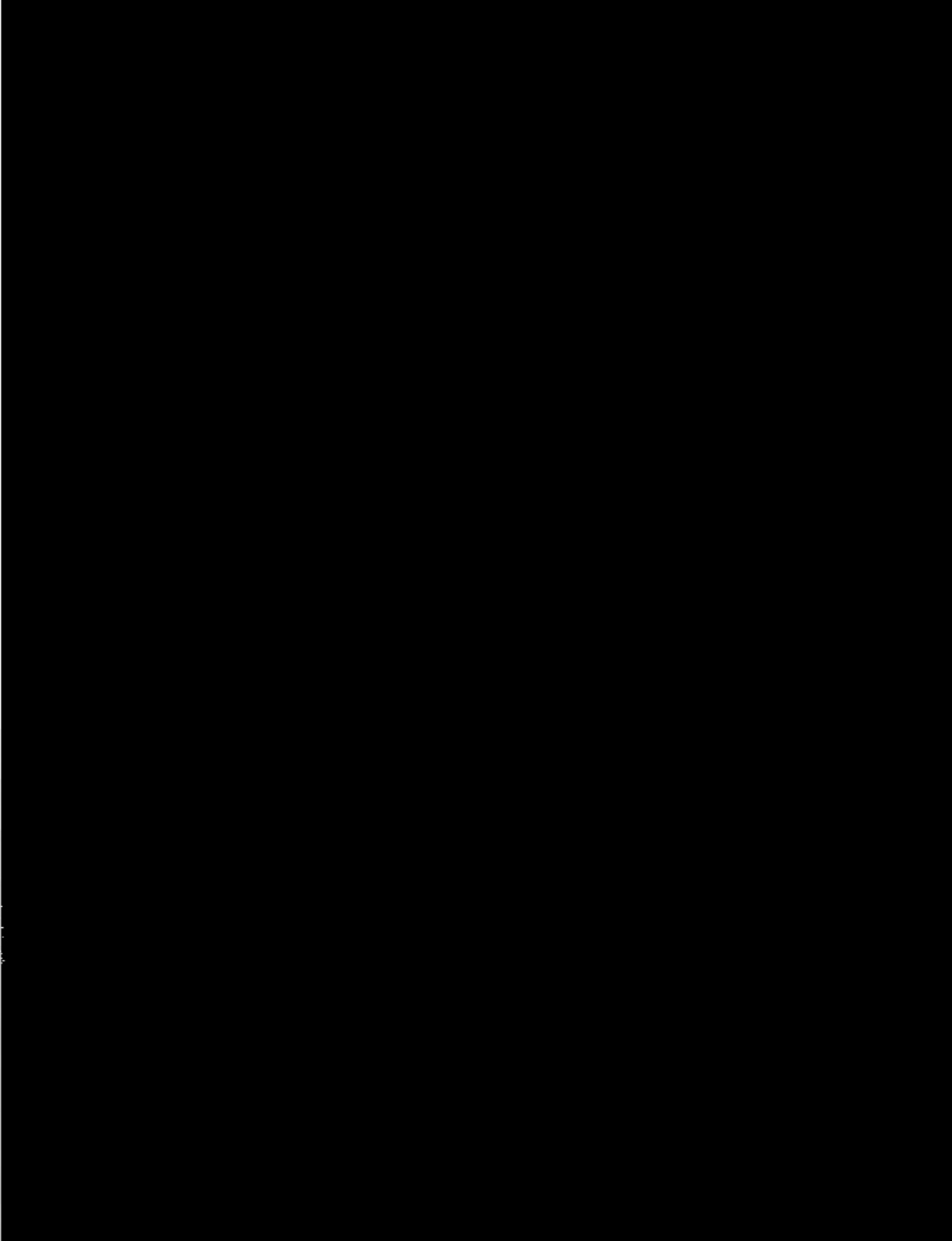

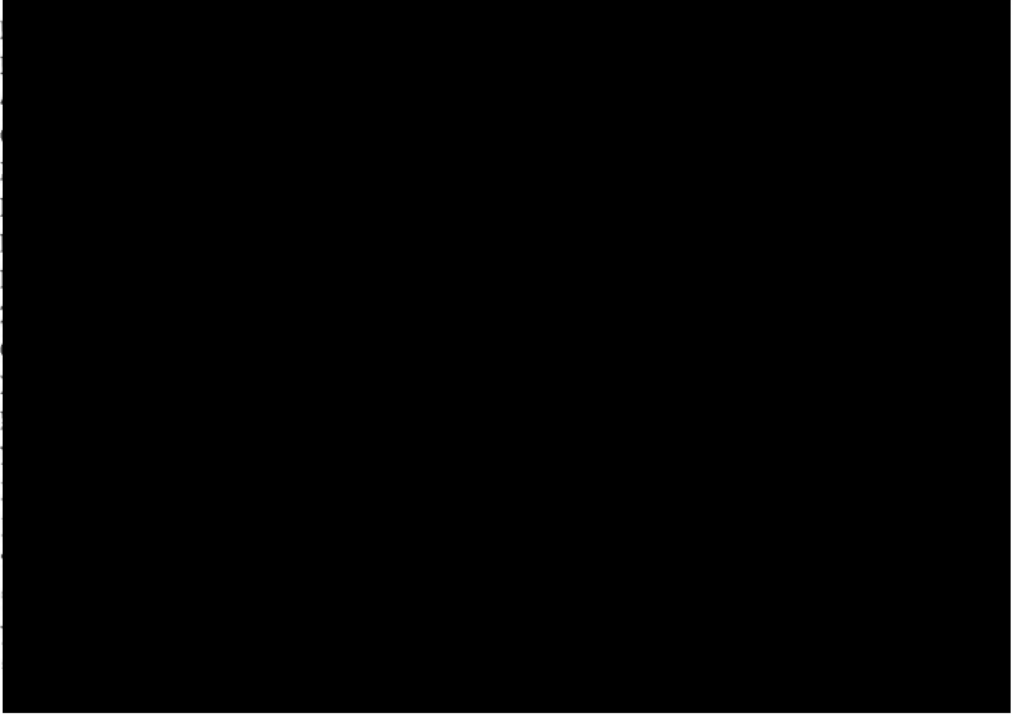





TOW ONLY

File Number 190023109

Riverside Police Department Vehicle Release Form

Stored Vehicle 30 Day Impound Recovered Vehicle

Date of Impound 08/12/2019 Eligible Release Date 09/03/2019

Vehicle Year 2002 Make GMC Model SONOMA

License Plate 6Z11833 Vin Number 1GTCS19W328231712

Registered Owner LUTHER

Legal Owner —

Date of Hearing _____ Letter Sent _____

Tow Company BAUMANS

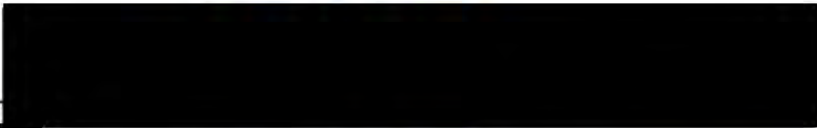
Please deliver the above vehicle to: 

Name:  ID#: 394 Date: 09/06/2019 @1631
Clerk or Officer Releasing Vehicle

I, the undersigned, do hereby certify under penalty of perjury, that I am legally authorized and entitled to take possession of the vehicle described above and do hereby relieve and guarantee to protect the agency named above, their officers, employees, or agents, against loss or liability and become liable for all expenses accrued or accruing against said vehicle occasioned by the impounding of same.

Signature: 
Owner, Legal Owner

Date: 09/06/2019

Signature: 
Registered Owner

Date: 9/6/19

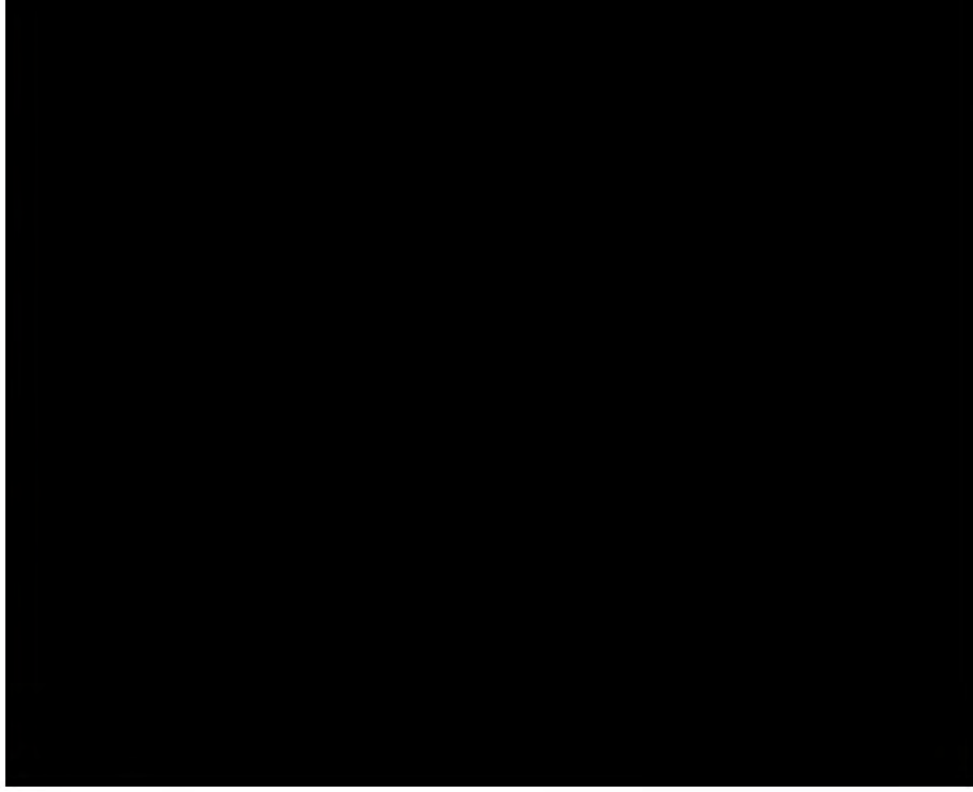

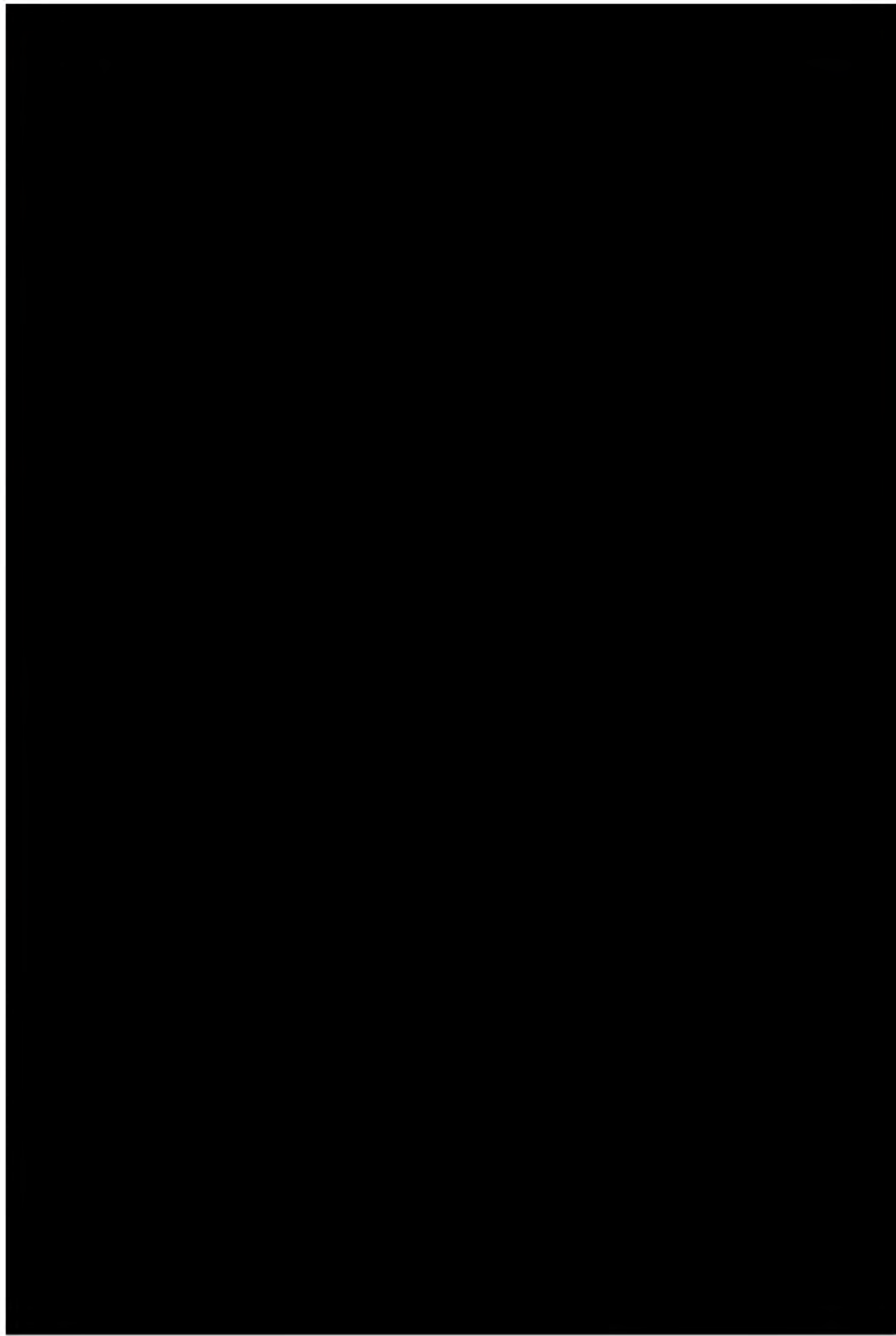

The right side of the page is mostly blank, with some faint, illegible markings and a vertical line on the far right edge, possibly indicating a page boundary or a scanning artifact.

STATE OF CALIFORNIA

CERTIFICATION OF VITAL RECORD

COUNTY OF RIVERSIDE

RIVERSIDE, CALIFORNIA

3052019171262

CERTIFICATE OF DEATH

3201933010618

Form containing personal data, usual residence, spouse/next of kin, funeral directory, place of death, cause of death, physician's certification, and coroner's use only sections.

CERTIFIED COPY OF VITAL RECORD

STATE OF CALIFORNIA }
COUNTY OF RIVERSIDE } SS

This is a true and exact reproduction of the document officially registered and placed on file by the Riverside University Health System, Department of Public Health.

DATE ISSUED Sep 3, 2019

Dr. Cameron Kaiser, M.D., County Health Officer
RIVERSIDE COUNTY, CALIFORNIA

This copy is not valid unless prepared on an engraved border, displaying the date, seal, and signature of the Registrar.

ANY ALTERATION OR ERASURE VOIDS THIS CERTIFICATE





A Public Service Agency

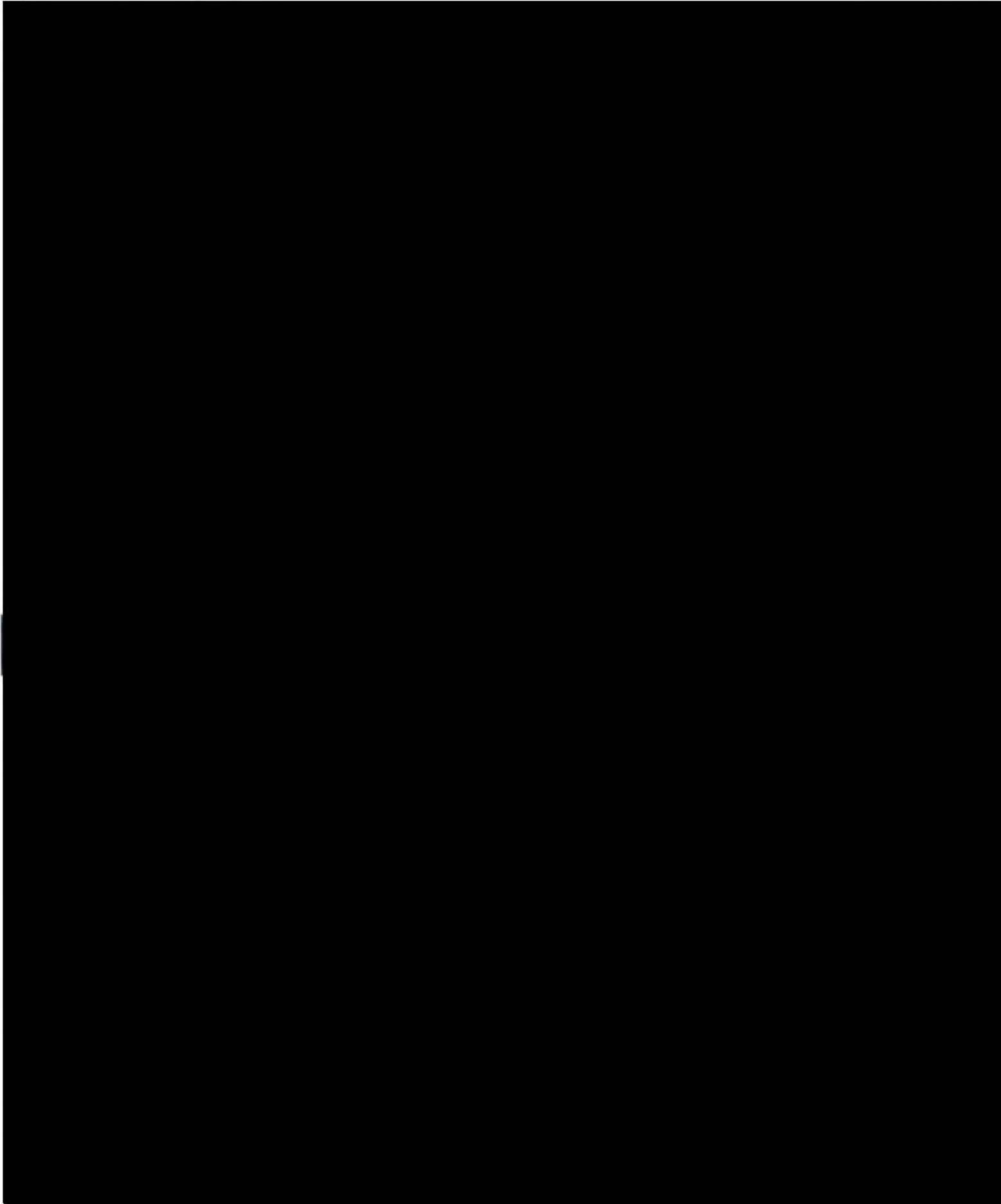

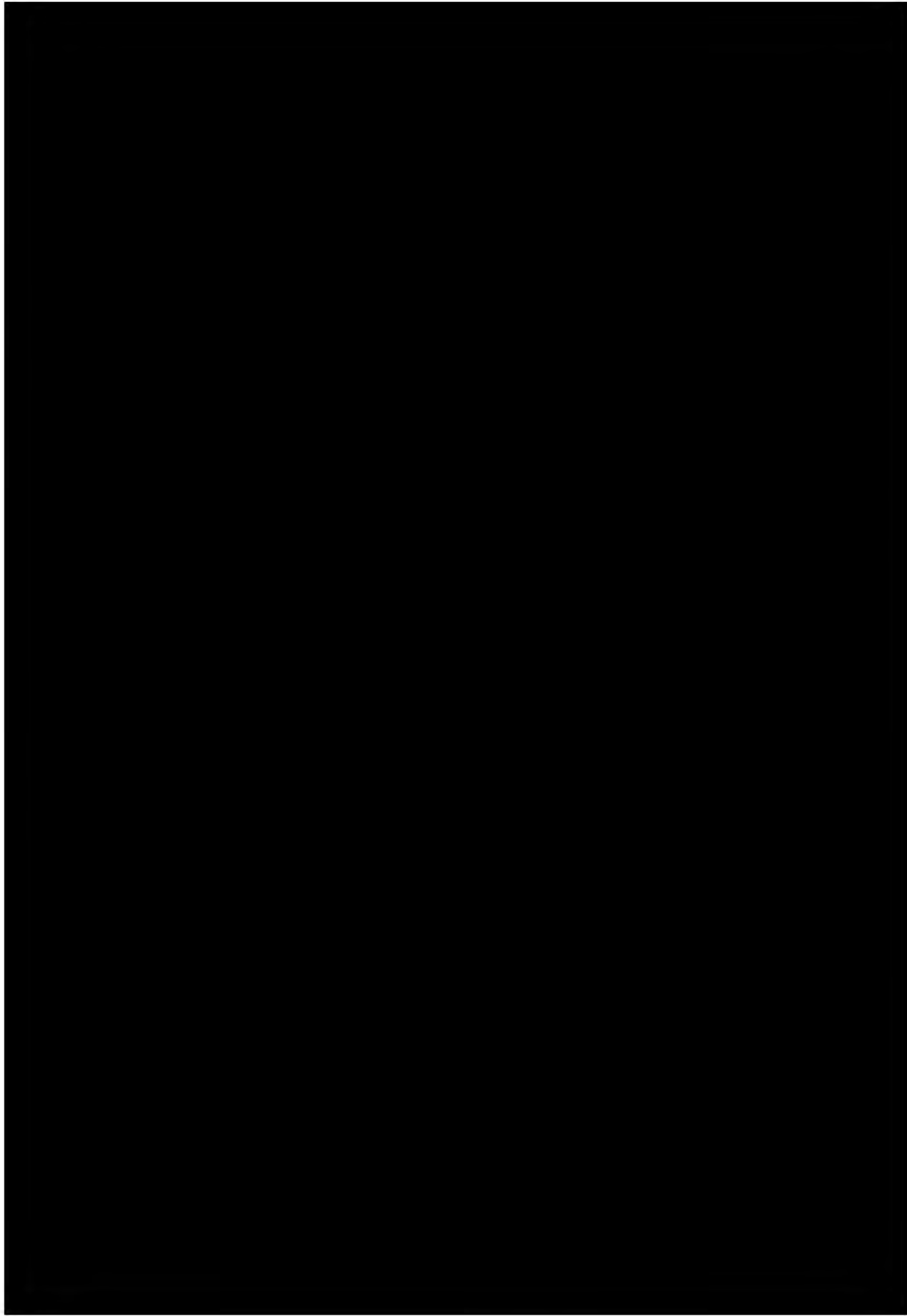





Faint, illegible text is visible on the right side of the page, appearing to be bleed-through from the reverse side. The text is too light to transcribe accurately but seems to consist of several lines of a document.



CALIFORNIA

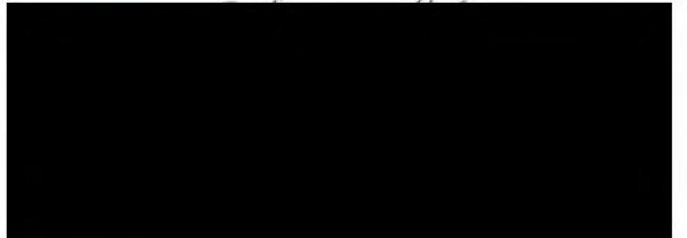
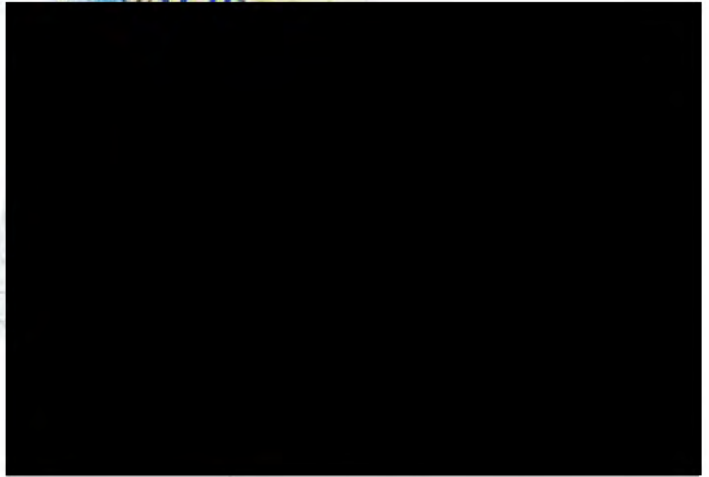

California ^{USA}

POWER LICENSE

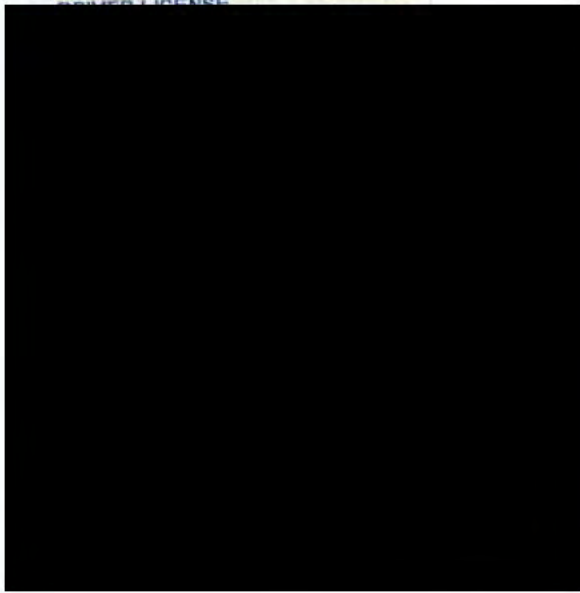

File Number 190023109

Riverside Police Department Vehicle Release Form

Stored Vehicle 30 Day Impound Recovered Vehicle

Date of Impound 08/12/19 Eligible Release Date 08/29/19

Vehicle Year 2015 Make KIA Model OPT

License Plate 7MYW037 Vin Number 5XYGN4A7XFC0497276

Registered Owner [REDACTED]

Legal Owner Wells Fargo Auto

Date of Hearing _____ Letter Sent _____

Tow Company Exclusive Tow [REDACTED]

Please deliver the above vehicle to: [REDACTED] CDL Valid

Name: [REDACTED] ID#: 1918 Date: 9/4/19
Clerk or Officer - Releasing Vehicle

I, the undersigned, do hereby certify under penalty of perjury, that I am legally authorized and entitled to take possession of the vehicle described above and do hereby relieve and guarantee to protect the agency named above, their officers, employees, or agents, against loss or liability and become liable for all expenses accrued or accruing against said vehicle occasioned by the impounding of same.

Signature: _____ Date: _____
Owner, Legal Owner or Agent

Signature: _____ Date: 9/4/19
Registered Owner [REDACTED]

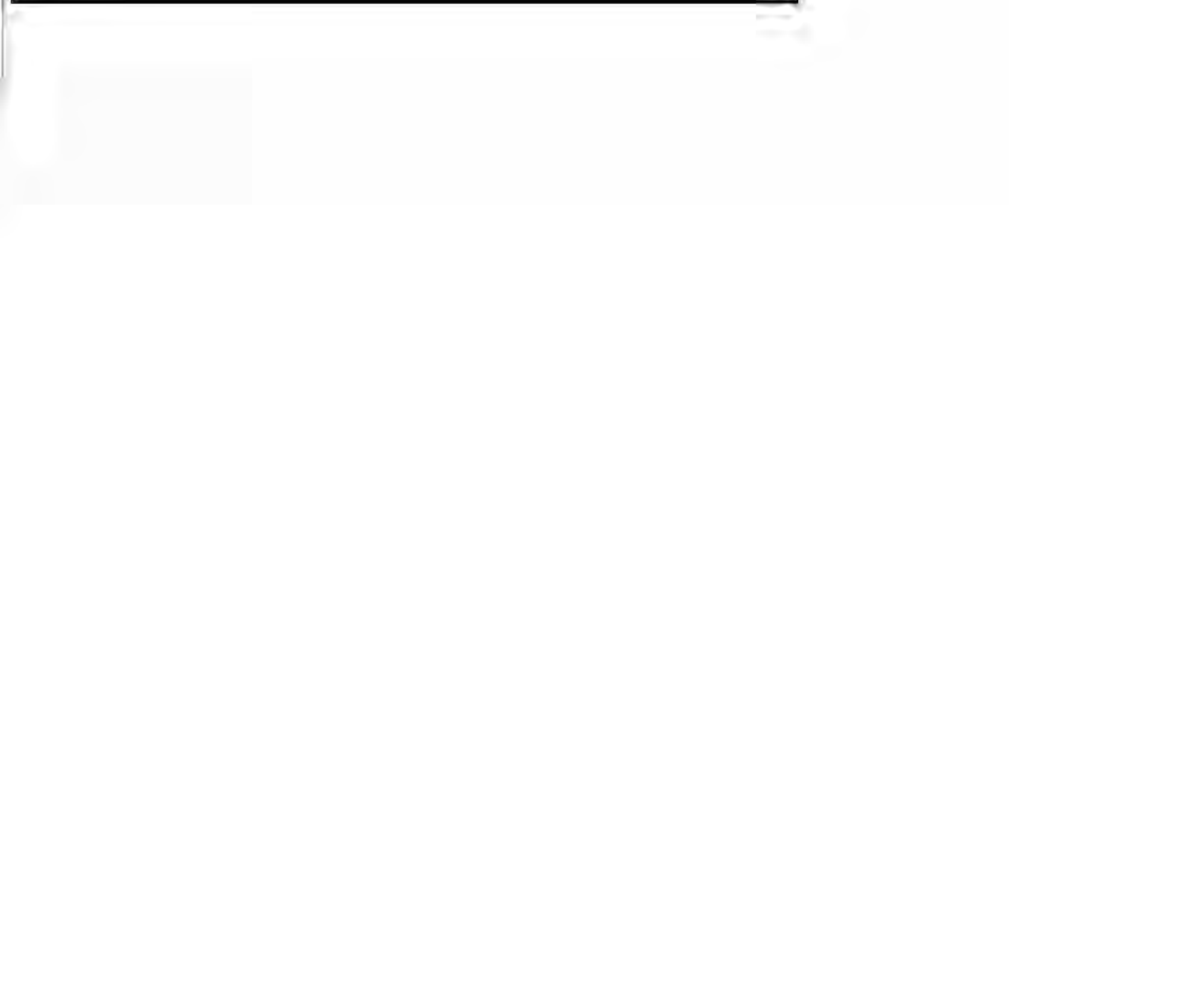
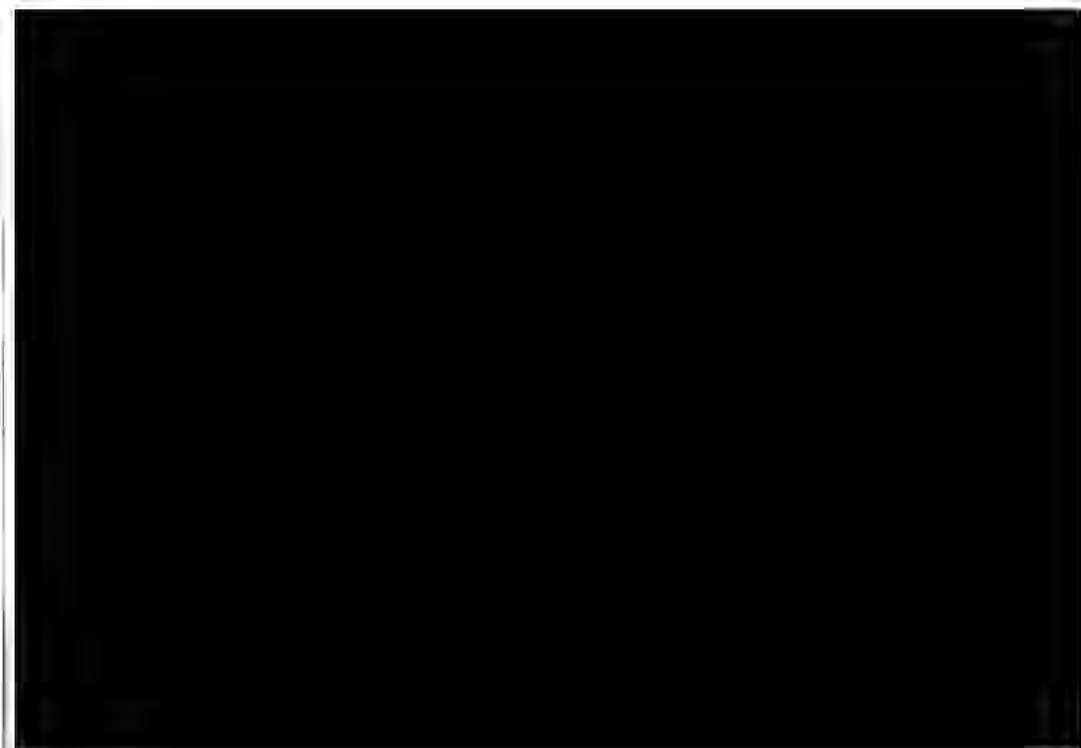

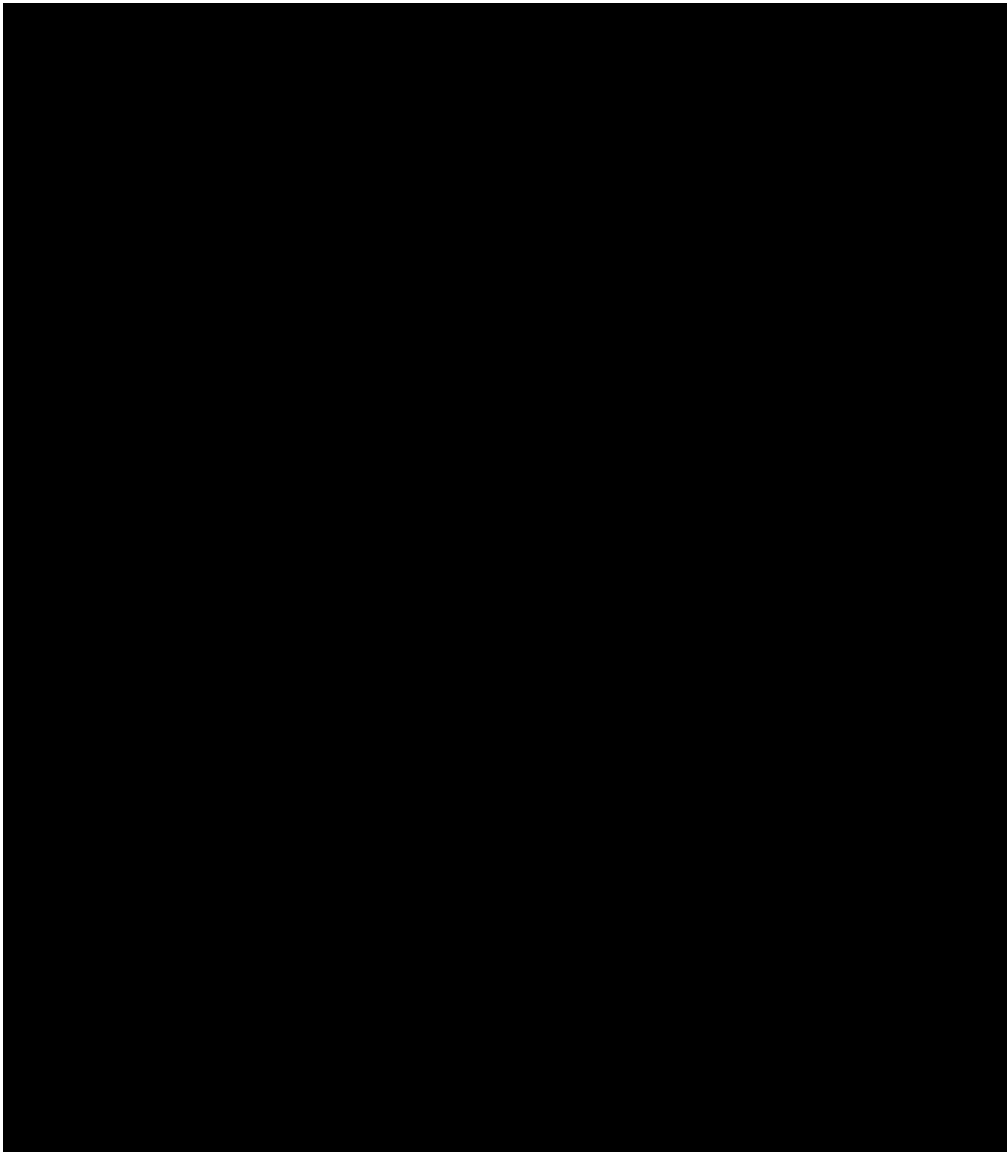

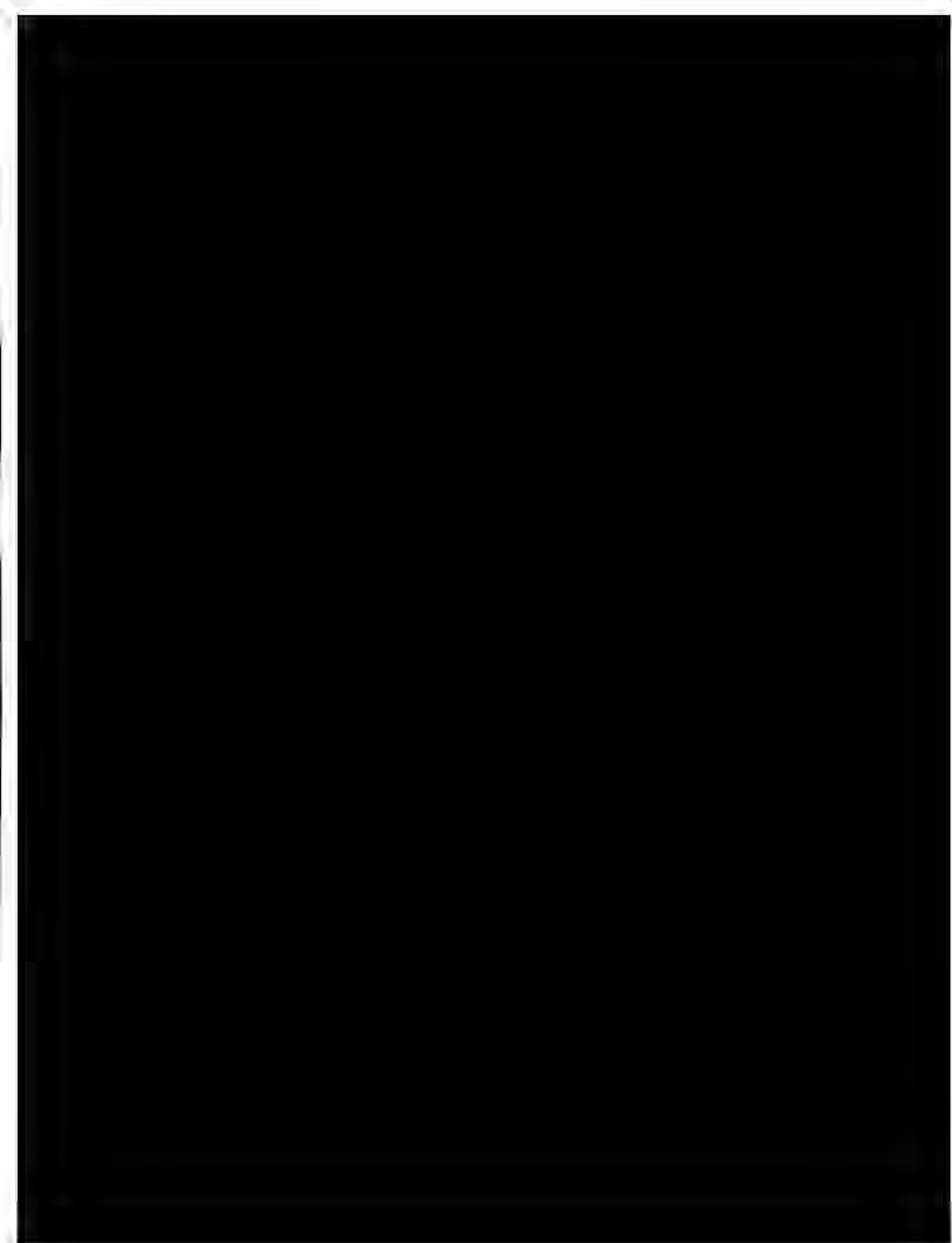

INFINITY. Temporary Insurance Card

Company: Infinity Insurance Company

PO Box 830807 Birmingham, AL 35283-0807

Policy No: 104601042560001

Effective Date: 01/18/2019

Vehicle(s)

VIN

2015 KIA OPTIMA

5XXGN4A7XFG497276

Insured(s)

Producer

[REDACTED]

AUTO CLUB INSURANCE AGENC
3333 Fairview Rd A451
Costa Mesa CA 92626
8884162402

Insurance Identification Card Issued Pursuant to California Law. NAIC # 22268

This card expires 30 days after effective date shown. Any alteration will void this card!

If Roadside Assistance is selected for your policy, please contact (877) 512-6964.

CALIFORNIA DRIVER LICENSE



**Riverside Police Department
PROPERTY REPORT**

File No.
190023109

Date/Time
08/12/19 -05:38

Type of Complaint 187 - MURDER		Address Box Springs/ Eastridge Ave			
Victim [REDACTED]	DOB	Sex M	Race White	Address	
Arrestee / Suspect	DOB	Sex	Race	Address	
Arrestee / Suspect	DOB	Sex	Race	Address	
Arrestee / Suspect	DOB	Sex	Race	Address	
Finder [REDACTED]	DOB	Sex M	Race White	Address 10540 Magnolia Ave - Riversi	Phone No.
Supvr. Approving [REDACTED]	RMC/RSC Case No.			Property Clerk	

Item	Owner	Itemize, Describe, List Serial Numbers... Only 1 Article per line	Prop. Loc.	Rel. Dispo
TF01		(2) EXPENDED .22 CALIBER CARTRIDGE CASE TEST-FIRE EXEMPLARS- FROM ITEM #OV99	MAG	

* Last Item *



Bureau of Alcohol, Tobacco, Firearms and Explosives
National Integrated Ballistics Information Network



Notification of Acquisition and Correlation

Submission Information:		NIBIN Number:	N19S2074
Name:	[REDACTED]	Agency Case Number:	190023109
Agency:	Riverside Police Department	Receipt Date:	10/31/2019
	10540 Magnolia Avenue, Suite B Riverside, CA 92505	Method:	UPS - 1Z 26R 071 03 5514 6619

In an effort to provide the most timely results possible to investigators while maintaining the highest level of accuracy possible, when multiple items are submitted for NIBIN examination and entry, all are grouped based on similarities observed by trained NIBIN personnel and an example from each group is entered into IBIS. All items not entered would possibly be duplications in the database. In the event that an item is unsuitable for NIBIN entry for other reasons, this is noted separately. Firearms that are submitted to the NIBIN Branch are documented for demographic information and cartridge case test samples obtained for acquisition. No examination or function test is performed, and the firearms must be submitted to a qualified firearm examiner in a forensic laboratory if these examinations are required.

The following exhibit(s) were acquired into the Integrated Ballistics Identification System (IBIS) and correlated with the databases in the designated zones(s):

Exhibit #	Zone(s)	Lead* Developed		Comments
		No	Yes	
TF01	3	X		Received two .22 caliber test fired cartridge cases, reportedly fired from a Savage .22 caliber rifle, model 64 with serial # 2937401. One was selected for entry.

THIS IS A NOTIFICATION OF A PRESUMPTIVE INVESTIGATIVE LEAD FROM NIBIN ENTRY.

Evidence may be confirmed by microscopic comparison when requested. Please submit a completed request for laboratory examination to your partner laboratory requesting IBIS lead confirmation.

Zones:	1 - CT, DC, DE, MA, MD, ME, NH, NJ, NY, PA, RI, VA, VT, WV	4 - AK, CA (Northern), CO, ID, MT, NV, OR, UT, WA, WY
	2 - AL, AR, FL, GA, LA, MS, NC, PR, SC, TN, VI	5 - IA, IL, IN, KS, KY, MI, MN, MO, NE, ND, OH, SD, WI
	3 - AZ, CA (Southern), GU, HI, NM, NV (Las Vegas Metro), OK, TX	

Acquired images will be retained in the system for future comparative purposes. You will be notified if a NIBIN Lead is developed at a later date.

Analyst: [REDACTED]

11/14/19
Date

Page | of |



Bureau of Alcohol, Tobacco, Firearms and Explosives
National Integrated Ballistics Information Network



Notification of Acquisition and Correlation

Submission Information:		NIBIN Number:	N19S2074 (2)
Name:	[REDACTED]	Agency Case Number:	190023109
Agency:	Riverside Police Department 10540 Magnolia Avenue, Suite B Riverside, CA 92505	Receipt Date:	12/20/2019
		Method:	UPS - 1Z 26R 071 03 5681 1746

In an effort to provide the most timely results possible to investigators while maintaining the highest level of accuracy possible, when multiple items are submitted for NIBIN examination and entry, all are grouped based on similarities observed by trained NIBIN personnel and an example from each group is entered into IBIS. All items not entered would possibly be duplications in the database. In the event that an item is unsuitable for NIBIN entry for other reasons, this is noted separately. Firearms that are submitted to the NIBIN Branch are documented for demographic information and cartridge case test samples obtained for acquisition. No examination or function test is performed, and the firearms must be submitted to a qualified firearm examiner in a forensic laboratory if these examinations are required.

The following exhibit(s) were acquired into the Integrated Ballistics Identification System (IBIS) and correlated with the databases in the designated zone(s):

Exhibit #	Zone(s)	Lead* Developed		Comments
		No	Yes	
TF-02	3	X		Received two 5.56x45mm caliber test fired cartridge cases, reportedly fired from an Unknown 5.56 caliber rifle, model unknown with an unknown serial #. One was selected for entry.

THIS IS A NOTIFICATION OF A PRESUMPTIVE INVESTIGATIVE LEAD FROM NIBIN ENTRY.

Evidence may be confirmed by microscopic comparison when requested. Please submit a completed request for laboratory examination to your partner laboratory requesting IBIS lead confirmation.

Zones	1 - CT, DC, DE, MA, MD, ME, NH, NJ, NY, PA, RI, VA, VT, WV	4 - AK, CA (Northern), CO, ID, MT, NV, OR, UT, WA, WY
	2 - AL, AR, FL, GA, LA, MS, NC, PR, SC, TN, VI	5 - IA, IL, IN, KS, KY, MI, MN, MO, NE, ND, OH, SD, WI
	3 - AZ, CA (Southern), GU, HI, NM, NV (Las Vegas Metro), OK, TX	

Acquired images will be retained in the system for future comparative purposes. You will be notified if a NIBIN Lead is developed at a later date.

Analyst: [REDACTED]

12/23/19

Date

Page | of |



Riverside Police Department

Officer Report

File Number:
190023109-002

Administrative Information

Subject:	187 P.C., MURDER				
Date(s) and Time(s) of Occurrence Or Between:	//				
Location Of Occurrence:	Box Springs Blvd / Eastridge Ave RIVERSIDE				
Date/Time Reported:	8/12/2019 5:38:06 PM	Day:			
Date Of Report:	8/12/2019 9:44:52 PM	Type Of Premises:			
NPC:		RD:	PG08	Beat:	3
Was There a Witness To The Crime?					
Can a Suspect Be Named Or Identified?		By Whom?			
Can a Suspect Vehicle Be Identified?		By Whom?			

Code Section Classification:

Offense	Code Section
MURDER:SECOND DEGREE ON PEACE OFFICER	187(A)
Completed	Yes

Records Section

Reporting Officer:	[REDACTED]		
115 Qualified:	Yes		
Send Copies Of This Report To:			
DOJ/NCIC Entered?		Name/ID	
DOJ/NCIC Cancelled?		Name/ID	
APR Sent?		Name/ID	
APB Sent?		Name/ID	

Public Narrative

--

Supervisor Approving

Approving Supervisor:	[REDACTED]
Date Reviewed:	8/20/2019 12:00:00 AM



Riverside Police Department

Officer Report

File Number:
190023109-002

Witness Information

Code:		Name:	[REDACTED]			
[REDACTED]	[REDACTED]	[REDACTED]	[REDACTED]	[REDACTED]	[REDACTED]	[REDACTED]
[REDACTED]	[REDACTED]	[REDACTED]	[REDACTED]	[REDACTED]	[REDACTED]	[REDACTED]
[REDACTED]	[REDACTED]	[REDACTED]	[REDACTED]	[REDACTED]	[REDACTED]	[REDACTED]
Notes:						

Witness Addresses:

Address Type	Address	City, State ZIP	County
[REDACTED]	[REDACTED]	[REDACTED]	[REDACTED]

Witness Phones:

Phone Type	Phone Number
[REDACTED]	[REDACTED]

Evidence Information

Physical Evidence Present?		Physical Evidence Seized?	
Photographs Taken?		Photographer?	
Weapon Seized?		Weapon(s) Taken For Safety?	
Gang Related?		Sensitive Data?	
Fingerprint Search Made?		Fingerprints Obtained?	
Narcotics Seized?		Narcotics Field Tested?	
Audio Recording Available?		In Car Recording Available?	
Body Worn Camera Recording Available?			
Type of Weapon, Force, Or Device Used?			
Motive:			

Narrative

- 1 NARRATIVE:
- 2 On August 18, 2019, at about 1738 hours, Officer [REDACTED] and I responded to the area of Eastridge
- 3 Avenue and Box Springs Blvd regarding CHP officers being shot at by a suspect. Upon our arrival, at
- 4 the intersection of Box Springs Blvd and Eastridge Avenue I heard gunfire and saw the suspect by a



Riverside Police Department

Officer Report

File Number:
190023109-002

5 white truck. I was unable to get a clear view due to our position. After the scene was cleared and the
6 suspect was taken into custody, I assisted by placing crime scene tape at Box Springs Blvd and
7 Eastridge Avenue.

8
9 I then spoke with witness [REDACTED] and the following is a summary of his statement.

10 W/[REDACTED] stated he was traveling westbound on Eastridge Avenue and as he passed Box Springs Blvd,
11 he heard gunfire occurring and stated he heard bullets whizzing by his vehicle. W/[REDACTED] stated he
12 stopped his vehicle and noticed a suspect was in a gunfight with CHP officers. W/[REDACTED] stated as he
13 backed his vehicle onto Box Springs Rd just south of Eastridge Avenue and he saw the suspect
14 shooting at officers as he moved side to side to the front of the white truck. W/[REDACTED] stated the
15 gunfight lasted about 10 minutes. W/[REDACTED] stated during the gunfight there was a lull in gunfire and
16 as that occurred the suspect approached where two CHP officers were located and the suspect shot
17 two rounds the officers. W/[REDACTED] stated when the suspect did such the two officers were down on
18 the ground. W/[REDACTED] was unable to provide a suspect description due to the distance.

19
20 W/[REDACTED] noted earlier when he was driving his son to work (located just west of Box Springs Rd), he
21 had seen the vehicle pulled over by CHP. W/[REDACTED] stated there was a tow truck on scene, but he was
22 unable to recall the subject description, due to him passing by. W/[REDACTED] had nothing further.

23

RIVERSIDE POLICE DEPARTMENT

Date Printed: 10/27/2022 9:48 AM	Case Report Number: 190023109-002	Page: 3 of 3	Ver. 1.3.3
-------------------------------------	--------------------------------------	-----------------	---------------



Riverside Police Department

Officer Report

File Number:
190023109-003

Administrative Information

Subject:	187 (A) - PC - MURDER				
Date(s) and Time(s) of Occurrence Or Between:	//				
Location Of Occurrence:	Box Springs Bldg / Eastridge Ave RIVERSIDE				
Date/Time Reported:	8/12/2019 5:38:06 PM	Day:			
Date Of Report:	8/12/2019 10:57:19 PM	Type Of Premises:			
NPC:		RD:	PG08	Beat:	3
Was There a Witness To The Crime?					
Can a Suspect Be Named Or Identified?		By Whom?			
Can a Suspect Vehicle Be Identified?		By Whom?			

Code Section Classification:

Records Section

Reporting Officer:	[REDACTED]		
115 Qualified:	Yes		
Send Copies Of This Report To:			
DOJ/NCIC Entered?		Name/ID	
DOJ/NCIC Cancelled?		Name/ID	
APR Sent?		Name/ID	
APB Sent?		Name/ID	

Public Narrative

See initial report for further details.

Supervisor Approving

Approving Supervisor:	[REDACTED]
Date Reviewed:	8/14/2019 12:00:00 AM

Evidence Information

Physical Evidence Present?		Physical Evidence Seized?	
----------------------------	--	---------------------------	--



Riverside Police Department

Officer Report

File Number:
190023109-003

Photographs Taken?		Photographer?	
Weapon Seized?		Weapon(s) Taken For Safety?	
Gang Related?		Sensitive Data?	
Fingerprint Search Made?		Fingerprints Obtained?	
Narcotics Seized?		Narcotics Field Tested?	
Audio Recording Available?		In Car Recording Available?	
Body Worn Camera Recording Available?			
Type of Weapon, Force, Or Device Used?			
Motive:			

Narrative

1 **Evidence:**

2 Department BWC

3

4 **Source:**

5 On Monday, August 12, 2019, at approximately 1738 hours, in the City and County of Riverside,
6 Partner Officer [REDACTED] and I were assigned to work uniformed patrol in a marked black and
7 white police car. At this time, we were dispatched to the area of Box Springs Blvd and Eastridge
8 Avenue, reference an "11-11 shots fired, CHP Motor Officer down." Dispatch further advised
9 the suspect was described as a White male adult wearing sunglasses and armed with an AR-15
10 rifle. I activated my overhead red and blue lights and sirens at the intersection of Chicago
11 Avenue and University Avenue. We drove to the southbound 215 fwy and Eucalyptus/Eastridge
12 Avenue off ramp.

13

14 **Details:**

15 When we arrived to the scene, I parked my vehicle on the Eucalyptus/Eastridge Avenue off ramp
16 using my activated emergency lights to block any vehicles from entering the crime scene. I
17 activated my Department Issued Body-Worn Video System (BVS) and ran to the scene where I
18 found additional officers holding cover for the CHP officer which was lying supine in between
19 the CHP units. Partner Officer [REDACTED] and I, along with other officers on scene, assisted in
20 carrying the downed CHP officer to Unit Air-1 for air transport for medical treatment (Air
21 Medical Evacuation).

22

23 Ofc. [REDACTED] and I located Sgt [REDACTED] who advised us to preserve the crime scene by placing
24 yellow crime scene tape around the scene. We were later relieved from our duties by Officer [REDACTED]
25 [REDACTED] and his partner per Lt. [REDACTED]

26

27 No further information.



Riverside Police Department Officer Report

File Number:
190023109-003

28

RIVERSIDE POLICE DEPARTMENT

Date Printed: 10/27/2022 9:53 AM	Case Report Number: 190023109-003	Page: 3 of 3	Ver. 1.3.3
--	---	------------------------	----------------------



Riverside Police Department

Officer Report

File Number:
190023109-004

Administrative Information

Subject:	1111 - OFFICER NEEDS BACK-UP/URGENT RESPONSE				
Date(s) and Time(s) of Occurrence Or Between:	//				
Location Of Occurrence:	Box Springs Bldg / Eastridge Ave RIVERSIDE				
Date/Time Reported:	8/12/2019 5:38:06 PM	Day:			
Date Of Report:	8/12/2019 10:37:44 PM	Type Of Premises:			
NPC:		RD:	PG08	Beat:	3
Was There a Witness To The Crime?					
Can a Suspect Be Named Or Identified?		By Whom?			
Can a Suspect Vehicle Be Identified?		By Whom?			

Code Section Classification:

Offense	Code Section
MURDER	187(A)
Completed	Yes

Records Section

Reporting Officer:	[REDACTED]		
115 Qualified:	Yes		
Send Copies Of This Report To:			
DOJ/NCIC Entered?		Name/ID	
DOJ/NCIC Cancelled?		Name/ID	
APR Sent?		Name/ID	
APB Sent?		Name/ID	

Public Narrative

--	--	--	--

Supervisor Approving

Approving Supervisor:	[REDACTED]		
Date Reviewed:	8/20/2019 12:00:00 AM		



Riverside Police Department

Officer Report

File Number:
190023109-004

Witness Information

[REDACTED]	[REDACTED]	[REDACTED]	[REDACTED]
[REDACTED]	[REDACTED]	[REDACTED]	[REDACTED]
[REDACTED]	[REDACTED]	[REDACTED]	[REDACTED]
[REDACTED]	[REDACTED]	[REDACTED]	[REDACTED]
Notes:			

Witness Addresses:

Address Type	Address	City, State ZIP	County
[REDACTED]	[REDACTED]	[REDACTED]	[REDACTED]

Witness Phone:

[REDACTED]	[REDACTED]
[REDACTED]	[REDACTED]

Witness Information

[REDACTED]	[REDACTED]	[REDACTED]	[REDACTED]
[REDACTED]	[REDACTED]	[REDACTED]	[REDACTED]
[REDACTED]	[REDACTED]	[REDACTED]	[REDACTED]
[REDACTED]	[REDACTED]	[REDACTED]	[REDACTED]
Notes:			

Witness Addresses:

Address Type	Address	City, State ZIP	County
[REDACTED]	[REDACTED]	[REDACTED]	[REDACTED]

Witness Phones:

[REDACTED]	[REDACTED]
[REDACTED]	[REDACTED]

Evidence Information

Physical Evidence Present?		Physical Evidence Seized?	
Photographs Taken?		Photographer?	
Weapon Seized?		Weapon(s) Taken For Safety?	



Riverside Police Department

Officer Report

File Number:
190023109-004

Gang Related?		Sensitive Data?	
Fingerprint Search Made?		Fingerprints Obtained?	
Narcotics Seized?		Narcotics Field Tested?	
Audio Recording Available?		In Car Recording Available?	
Body Worn Camera Recording Available?			
Type of Weapon, Force, Or Device Used?			
Motive:			

Narrative

1 Notification:

2 On 08/12/19 at approximately 1738 hours, UNET Partner Officer [REDACTED] and I were in uniformed
3 patrol driving a clearly marked black and white patrol vehicle. We responded to the area of Box
4 Springs Boulevard and Eastridge Avenue in the City and County of Riverside. We approached the
5 location from southbound Box Springs Boulevard.

6 Statements:

7 I spoke to W1/[REDACTED] who was driving a Blue 2016 Freight Liner [REDACTED]). He stated he
8 was driving the semi truck north bound on Box Springs approaching East Ridge when he heard one
9 gunshot. He said he did not see anything or hear anything else.

10 I spoke to W2/[REDACTED] W2/[REDACTED] is a RTA Bus Driver and was driving Bus [REDACTED] out of the RTA
11 Perris Station. The following is a summary of his statements: he was driving the RTA Bus westbound
12 on Eastridge Avenue approaching Box Springs. As he was approaching the 215 Freeway, he heard
13 popping noises. He noticed there was a motor officer's motorcycle parked approximately 10 feet
14 behind a white truck or SUV. He then noticed there was a male (S1/Aaron) standing on the front
15 driver side of the white vehicle with a rifle in his hand. W2/[REDACTED] said the rifle had attachments on
16 it. W2/[REDACTED] then realized S1/Aaron was shooting at the CHP officer who was standing behind the
17 motorcycle. W2/[REDACTED] said he immediately ran to the back of the RTA Bus and lied down on the
18 ground to take cover. As W2/[REDACTED] took cover, the RTA Bus began to roll south west across
19 Eastridge because W2/[REDACTED] did not put the vehicle in park. The RTA Bus struck the south guard
20 rail on Eastridge Avenue. W2/[REDACTED] said he got back into the driver seat. As he got into the driver
21 seat to drive away, he looked out the front passenger window and saw S1/Aaron loading his rifle.
22 W2/[REDACTED] said S1/Aaron was taking ammunition (Unknown if they were magazines or single
23 rounds) out of a green "Army Colored" bag by his feet and was still standing on the front driver side
24 of the white vehicle. W2/[REDACTED] said as the subject reloaded his rifle, his demeanor appeared as if it
25 were a "Sunday Picnic." He said the officer was now on the ground in the grass area partially in the
26 embankment for cover. W2/[REDACTED] said the officer was still returning fire. W2/[REDACTED] immediately
27 drove away and made a southbound turn onto Box Springs from Eastridge. He said he heard
28 approximately 50 shots but saw S1/Aaron shoot at the Officer approximately 11 to 12 time.



Riverside Police Department

Officer Report

File Number:
190023109-004

29 W2/ [REDACTED] advised me that the RTA bus has video surveillance that likely captured the incident.
30 Supervision on scene was notified.
31 After statements were taken, I directed a perimeter spot on Box Springs north of Eastridge. NFI.
32

RIVERSIDE POLICE DEPARTMENT



Riverside Police Department

Officer Report

File Number:
190023109-005

Administrative Information

Subject:	PC 187 Murder				
Date(s) and Time(s) of Occurrence Or Between:	//				
Location Of Occurrence:	Box Springs Bldg / Eastridge Ave RIVERSIDE				
Date/Time Reported:	8/12/2019 5:38:06 PM	Day:			
Date Of Report:	8/12/2019 11:57:11 PM	Type Of Premises:			
NPC:		RD:	PG08	Beat:	3
Was There a Witness To The Crime?					
Can a Suspect Be Named Or Identified?		By Whom?			
Can a Suspect Vehicle Be Identified?		By Whom?			

Code Section Classification:

Records Section

Reporting Officer:			
115 Qualified:	Yes		
Send Copies Of This Report To:			
DOJ/NCIC Entered?		Name/ID	
DOJ/NCIC Cancelled?		Name/ID	
APR Sent?		Name/ID	
APB Sent?		Name/ID	

Public Narrative

See original report for further details.

Supervisor Approving

Approving Supervisor:			
Date Reviewed:	8/20/2019 12:00:00 AM		

Evidence Information

Physical Evidence Present?		Physical Evidence Seized?	
----------------------------	--	---------------------------	--



Riverside Police Department

Officer Report

File Number:
190023109-005

Photographs Taken?		Photographer?	
Weapon Seized?		Weapon(s) Taken For Safety?	
Gang Related?		Sensitive Data?	
Fingerprint Search Made?		Fingerprints Obtained?	
Narcotics Seized?		Narcotics Field Tested?	
Audio Recording Available?		In Car Recording Available?	
Body Worn Camera Recording Available?			
Type of Weapon, Force, Or Device Used?			
Motive:			

Narrative

1 **Supplemental Report:**

2
3 On Monday, August 12, 2019, at approximately 5:38 PM, several officers from RPD were
4 requested for emergency assistance regarding a CHP Officer down in the area of Box Springs
5 Blvd and Eastridge Avenue. Ofc. [REDACTED] and I arrived on-scene to assist. See original/additional
6 reports for further details.
7

8 **Narrative:**

9
10 .On Monday, August 12, 2019, at approximately 5:38 PM, in the City and County of Riverside,
11 Partner Officer [REDACTED] and I were assigned to work uniformed patrol in a marked black and
12 white police car. At this time, we were dispatched to the area of Box Springs Blvd and Eastridge
13 Avenue, reference an "11-11 shots fired, CHP Motor Officer down." Dispatch further advised
14 the suspect was described as a White male adult wearing sunglasses and armed with an AR-15
15 rifle. Ofc. [REDACTED] activated our overhead red and blue lights and sirens at the intersection of
16 Chicago Avenue and University Avenue. We drove to the southbound 215 fwy and
17 Eucalyptus/Eastridge Avenue off ramp.
18

19 When we arrived to the scene, Ofc. [REDACTED] parked the vehicle on the Eucalyptus/Eastridge
20 Avenue off ramp using our activated emergency lights to block any vehicles from entering the
21 crime scene. I activated my Department Issued Body-Worn Video System (BVS) and ran to the
22 scene where I found additional officers holding cover for the CHP officer who was lying supine
23 in between the CHP units. Partner Officer [REDACTED] and I, along with other officers on scene,
24 assisted in carrying the downed CHP officer to Unit Air-1 for air transport for medical treatment
25 (Air Medical Evacuation).
26



Riverside Police Department

Officer Report

File Number:
190023109-005

27 Ofc. [REDACTED] and I located Sgt. [REDACTED] who advised us to secure the crime scene by placing
28 yellow crime scene tape around the scene. We were later relieved from our duties by Officer [REDACTED]
[REDACTED] and his partner per Lt. [REDACTED]
30
31 No further information.
32

RIVERSIDE POLICE DEPARTMENT

Date Printed: 10/27/2022 10:01	Case Report Number: 190023109-005	Page: 3 of 3	Ver. 1.3.3
-----------------------------------	--------------------------------------	-----------------	---------------



Riverside Police Department

Officer Report

File Number:
190023109-006

Administrative Information

Subject:	1111 - OFFICER NEEDS BACK-UP/URGENT RESPONSE				
Date(s) and Time(s) of Occurrence Or Between:	8/12/2019 5:38:00 PM //				
Location Of Occurrence:	Box Springs Bldg / Eastridge Ave RIVERSIDE				
Date/Time Reported:	8/12/2019 5:38:06 PM	Day:	Monday		
Date Of Report:	8/12/2019 11:31:09 PM	Type Of Premises:			
NPC:		RD:	PG08	Beat:	3
Was There a Witness To The Crime?					
Can a Suspect Be Named Or Identified?		By Whom?			
Can a Suspect Vehicle Be Identified?		By Whom?			

Code Section Classification:

Records Section

Reporting Officer:	[REDACTED]		
115 Qualified:	Yes		
Send Copies Of This Report To:			
DOJ/NCIC Entered?		Name/ID	
DOJ/NCIC Cancelled?		Name/ID	
APR Sent?		Name/ID	
APB Sent?		Name/ID	

Public Narrative

At the indicated date and time, I responded to the area of the Eastridge Avenue and Box Springs Road reference an 11-11 request by CHP. See narrative for further.

Supervisor Approving

Approving Supervisor:	[REDACTED]
Date Reviewed:	8/20/2019 12:00:00 AM

Evidence Information



Riverside Police Department

Officer Report

File Number:
190023109-006

Physical Evidence Present?		Physical Evidence Seized?	
Photographs Taken?		Photographer?	
Weapon Seized?		Weapon(s) Taken For Safety?	
Gang Related?		Sensitive Data?	
Fingerprint Search Made?		Fingerprints Obtained?	
Narcotics Seized?		Narcotics Field Tested?	
Audio Recording Available?		In Car Recording Available?	
Body Worn Camera Recording Available?			
Type of Weapon, Force, Or Device Used?			
Motive:			

Narrative

1 **NARRATIVE:**

2 On August 12, 2019 at about 1738 hours, partner Officer [REDACTED] and I responded to an "11-11"
 3 request by CHP reference an officer down and active shooter on Eastridge Avenue and Box Springs
 4 Road. Upon our arrival at the southbound 215 Freeway off-ramp at Eastridge Avenue, I heard
 5 multiple shots being fired in the area of Eastridge Avenue between our location and Box Springs
 6 Road. I ran towards the top of the off-ramp where I saw a marked patrol unit with several officers
 7 taking cover to the rear of the vehicle and facing west of our location. I also saw a CHP Officer down
 8 on the ground, behind the unit, and appeared to have sustained a gun shot wound to his left ankle. I,
 9 along with another CHP Officer, began to drag the injured officer east of the location and out of
 10 harms way. While pulling the officer, I saw a marked RSO Moreno Valley unit pull up near our
 11 location. I called out to them and waved them over to our location to assist. They drove the unit
 12 closer to our location and we placed the injured officer in the back of the patrol unit. The injured
 13 officer was then extricated from the scene to seek medical attention.

14
 15 After the injured officer was driven away from the scene, I then ran over to a marked patrol unit
 16 located just west of the off-ramp and where several officers were taking cover. Together, we moved
 17 up to the suspect's vehicle. As we moved up to the suspect's vehicle, I saw another CHP officer down
 18 on the sidewalk, northeast of the suspect's vehicle. I assisted in covering the officers as they
 19 approached the suspect who I saw was also down on the ground in front of his vehicle. The suspect
 20 was then taken into custody. After, I was posted on the southbound 215 Freeway/Eastridge Avenue
 21 off-ramp.

22
 23 See initial and supplemental reports for further information regarding this incident. No further
 24 information.

25



Riverside Police Department Officer Report

File Number:
190023109-006

26
27

RIVERSIDE POLICE DEPARTMENT

Date Printed: 10/27/2022 10:03	Case Report Number: 190023109-006	Page: 3 of 3	Ver. 1.3.3
-----------------------------------	--------------------------------------	-----------------	---------------



Riverside Police Department

Officer Report

File Number:
190023109-007

Administrative Information

Subject: 1111 - OFFICER NEEDS BACK-UP/URGENT RESPONSE				
Date(s) and Time(s) of Occurrence Or Between:		8/12/2019 5:38:00 PM //		
Location Of Occurrence:		Box Springs Bldg / Eastridge Ave RIVERSIDE		
Date/Time Reported:	8/12/2019 5:38:06 PM	Day:	Monday	
Date Of Report:	8/13/2019 12:58:43 AM	Type Of Premises:		
NPC:		RD:	PG08	Beat: 3
Was There a Witness To The Crime?				
Can a Suspect Be Named Or Identified?		By Whom?		
Can a Suspect Vehicle Be Identified?		By Whom?		

Code Section Classification:

Records Section

Reporting Officer:	[REDACTED]		
115 Qualified:	Yes		
Send Copies Of This Report To:			
DOJ/NCIC Entered?		Name/ID	
DOJ/NCIC Cancelled?		Name/ID	
APR Sent?		Name/ID	
APB Sent?		Name/ID	

Public Narrative

On the indicated date and time, partner Officer [REDACTED] and I responded to an 11-11 request by CHP. See narrative for further.

Supervisor Approving

Approving Supervisor:	[REDACTED]
Date Reviewed:	8/20/2019 12:00:00 AM

Witness Information

Code:		Name:	[REDACTED]
-------	--	-------	------------



Riverside Police Department

Officer Report

File Number:
190023109-007

[REDACTED]	[REDACTED]	[REDACTED]	[REDACTED]	[REDACTED]	[REDACTED]
[REDACTED]	[REDACTED]	[REDACTED]	[REDACTED]	[REDACTED]	[REDACTED]
[REDACTED]	[REDACTED]	[REDACTED]	[REDACTED]	[REDACTED]	[REDACTED]
[REDACTED]					

Witness Addresses:

Address Type	Address	City, State ZIP	County
[REDACTED]	[REDACTED]	[REDACTED]	[REDACTED]

Witness Phones:

Phone Type	Phone Number
[REDACTED]	[REDACTED]

Witness Information

[REDACTED]	[REDACTED]	[REDACTED]	[REDACTED]	[REDACTED]	[REDACTED]	[REDACTED]
[REDACTED]	[REDACTED]	[REDACTED]	[REDACTED]	[REDACTED]	[REDACTED]	[REDACTED]
[REDACTED]	[REDACTED]	[REDACTED]	[REDACTED]	[REDACTED]	[REDACTED]	[REDACTED]
[REDACTED]	[REDACTED]	[REDACTED]	[REDACTED]	[REDACTED]	[REDACTED]	[REDACTED]

Notes:

Witness Addresses:

Address Type	Address	City, State ZIP	County
[REDACTED]	[REDACTED]	[REDACTED]	[REDACTED]

Witness Phones:

[REDACTED]	[REDACTED]
[REDACTED]	[REDACTED]

Witness Information

[REDACTED]	[REDACTED]	[REDACTED]	[REDACTED]	[REDACTED]	[REDACTED]	[REDACTED]
[REDACTED]	[REDACTED]	[REDACTED]	[REDACTED]	[REDACTED]	[REDACTED]	[REDACTED]
[REDACTED]	[REDACTED]	[REDACTED]	[REDACTED]	[REDACTED]	[REDACTED]	[REDACTED]
[REDACTED]	[REDACTED]	[REDACTED]	[REDACTED]	[REDACTED]	[REDACTED]	[REDACTED]

Notes:

Witness Addresses:



Riverside Police Department

Officer Report

File Number:
190023109-007

Address Type	Address	City, State ZIP	County

Witness Phones:

Evidence Information			
Physical Evidence Present?		Physical Evidence Seized?	
Photographs Taken?		Photographer?	
Weapon Seized?		Weapon(s) Taken For Safety?	
Gang Related?		Sensitive Data?	
Fingerprint Search Made?		Fingerprints Obtained?	
Narcotics Seized?		Narcotics Field Tested?	
Audio Recording Available?		In Car Recording Available?	
Body Worn Camera Recording Available?			
Type of Weapon, Force, Or Device Used?			
Motive:			

Narrative

1
 2 Narrative:
 3
 4 On 08-12-19, partner Officer [REDACTED] and I were working uniformed patrol in a marked RPD
 5 patrol vehicle. Officer [REDACTED] and I are currently assigned to the University Neighborhood
 6 Enhancement Team (UNET). At approximately 1738 hours, we responded to the area of Eastridge
 7 Ave and the 215 freeway reference an "11-11" request by a CHP unit. RPD dispatch indicated CHP
 8 Officers were actively being shot at by an unknown suspect and a CHP Officer had been shot.
 9
 10 I immediately activated our marked patrol vehicles lights and sirens and began responding to the
 11 scene. While driving to the scene, RPD dispatch advised to enter from the east, on Eastridge Ave. As
 12 I was driving on the 215 freeway (S/B), I exited the Eastridge Ave off ramp. The off ramp was packed
 13 with vehicles. I heard multiple gunshots being fired south/west of my location. Partner Officer
 14 [REDACTED] and I immediately exited our patrol vehicle.
 15



Riverside Police Department

Officer Report

File Number:
190023109-007

16 Since Officer [REDACTED] was the passenger, he grabbed his department issued rifle and ran up the off
17 ramp south, toward Eastridge Ave. I went to the trunk area of our patrol vehicle and grabbed my
18 department approved rifle. I then proceeded south up the off ramp, toward Eastridge Ave. I saw
19 multiple officers from different agencies taking cover behind a marked patrol vehicle, on Eastridge
20 Ave, facing west. I joined in with those officers taking cover. I then looked west, toward the other
21 CHP vehicles and saw a CHP Officer laying on the ground. The CHP Officer was lying on the south
22 side off the street and looked unresponsive.

23
24 Assisting Officers and I then safely advanced as a team toward the unresponsive CHP Officer. As we
25 made it to the CHP Officer, I saw the unknown suspect lying to the front of a pick-up truck. The
26 suspect was lying on his back with a rifle on top of him near his knees. The suspects hands were
27 near the top portion of his body and not on the weapon. I then covered down on the suspect by
28 pointing my rifle toward him, while assisting Officers could move the unresponsive CHP Officer to
29 safety. Shortly after, an RSO deputy placed the suspect into handcuffs. Once the scene was secured,
30 I assisted CHP officers in locating any possible witnesses to this incident.

31
32 I spoke to W1, W2, and W3, who were all in the same vehicle ([REDACTED]) when this incident
33 occurred. W1, who was the driver of their vehicle, stated the following in summary:
34 He was exiting the S/B 215 freeway at the Eastridge Ave off ramp. He made a right (west) turn onto
35 Eastridge Ave. Once he did so, he saw an unknown female running in the middle of the street
36 yelling. He then heard multiple gun shots being fired, west of their location. He immediately tried to
37 reverse his vehicle, but was blocked by another vehicle. He then, along with his other passengers
38 (W2/W3), exited the vehicle and took cover on the east side of his vehicle. He then looked west on
39 Eastridge Ave and saw the suspect standing in front of his vehicle loading his rifle. W2, W3 and him
40 then ran north down the off ramp to take cover.

41
42 I spoke to W2 and W3 and they both had the same summarized statement as W1. None of the three
43 subjects were injured and there was no damage to their vehicle.

44
45 Officer [REDACTED] and I were then assigned to a perimeter position of the incident, at the Eastridge Ave
46 off ramp. I was handed a crime scene log from Det. [REDACTED], which he had already initiated. At
47 approximately 0400 hours, I was relieved from my perimeter position by Officer [REDACTED]

48
49 This incident was audio/visually recorded with my department issued body worn camera. See
50 assisting Officers initial and supplemental reports, for further regarding this incident.

51
52 No further information.
53

Date Printed: 10/27/2022 10:05	Case Report Number: 190023109-007	Page: 4 of 4	Ver. 1.3.3
-----------------------------------	--------------------------------------	-----------------	---------------



Riverside Police Department

Officer Report

File Number:
190023109-008

Administrative Information

Subject: 1111 - OFFICER NEEDS BACK-UP/URGENT RESPONSE				
Date(s) and Time(s) of Occurrence Or Between: //				
Location Of Occurrence: Box Springs Bldg / Eastridge Ave RIVERSIDE				
Date/Time Reported:	8/12/2019 5:38:06 PM	Day:		
Date Of Report:	8/13/2019 1:31:59 AM	Type Of Premises:		
NPC:		RD:	PG08	Beat: 3
Was There a Witness To The Crime?				
Can a Suspect Be Named Or Identified?		By Whom?		
Can a Suspect Vehicle Be Identified?		By Whom?		

Code Section Classification:

Offense	Code Section
MURDER	187(A)
Completed	Yes

Records Section

Reporting Officer:	[REDACTED]		
115 Qualified:	Yes		
Send Copies Of This Report To:			
DOJ/NCIC Entered?		Name/ID	
DOJ/NCIC Cancelled?		Name/ID	
APR Sent?		Name/ID	
APB Sent?		Name/ID	

Public Narrative

Supplemental report.

Supervisor Approving

Approving Supervisor:	[REDACTED]
Date Reviewed:	8/13/2019 12:00:00 AM



Riverside Police Department

Officer Report

File Number:
190023109-008

Evidence Information

Physical Evidence Present?		Physical Evidence Seized?	
Photographs Taken?		Photographer?	
Weapon Seized?		Weapon(s) Taken For Safety?	
Gang Related?		Sensitive Data?	
Fingerprint Search Made?		Fingerprints Obtained?	
Narcotics Seized?		Narcotics Field Tested?	
Audio Recording Available?		In Car Recording Available?	
Body Worn Camera Recording Available?			
Type of Weapon, Force, Or Device Used?			
Motive:			

Narrative

1 *This following is a supplemental report. For further details, please see initial report.*

2

3 **Evidence:**

4

5 COBAN Body-worn Camera

6

7 **Source:**

8

9 On Monday, August 12, 2019, at approximately 1738 hours, in the City and County of Riverside,
 10 I was assigned to work as a uniformed police officer in a marked black and white police car. At
 11 this time, we were dispatched to the area of Box Springs Blvd and Eastridge Avenue, reference
 12 an "11-11 shots fired, CHP Motor Officer down." Dispatch advised that the suspect was armed
 13 with an AR-15. I activated my overhead red and blue lights and sirens at the intersection of Main
 14 Street and Poplar Street.

15

16

17 **Details:**

18

19 When I arrived to the scene, I parked my vehicle in the Intersection of Eastridge Avenue and
 20 Box Springs Boulevard. At this time, Unit Air-1 was transporting a CHP officer for medical
 21 treatment (Air Medical Evacuation). I then responded to Eastridge Avenue and Sycamore



Riverside Police Department

Officer Report

File Number:
190023109-008

22 Canyon Boulevard to block eastbound traffic from entering the crime scene. Officer [REDACTED] and I
23 set up crime scene tape and stood by until relieved by Officer [REDACTED]

24
25 After I was relieved, Sergeant [REDACTED] requested that I respond to Riverside Community Hospital
26 to obtain a status on the injured officers. Upon arrival, I was told by emergency room staff that
27 the officers were not brought to RCH. Dispatch advised me that the injured CHP officers were
28 transported to Riverside University Health System Medical Center. Per Sergeant [REDACTED], I
29 responded to RUHS. Upon arrival, I spoke with Riverside County Sheriff's Lieutenant [REDACTED]
30 who provided me with a status of the injured CHP officers and the suspect. I briefed Sergeant
31 [REDACTED] and he requested that I standby at the hospital until further notice.

32 While at RUHS, I saw a Moreno Valley Police Department Unit (#11-137) covered with a green
33 tarp parked next to the West side emergency room entrance. I approached the deputies standing
34 by the vehicle who told me it was the unit that was utilized to transport the second injured CHP
35 officer. Corporal [REDACTED] told me he was driving the unit, Deputy [REDACTED]
36 [REDACTED] was the rear passenger applying a tourniquet to the injured CHP Officer, and Deputy
37 [REDACTED] was the front passenger. I then stood by with the unit due to it being a
38 crime scene. At approximately 2330 hours, I was relieved after RPD's Forensic Unit processed
39 the vehicle.

40 NFI

41

RIVERSIDE POLICE DEPARTMENT



Riverside Police Department

Officer Report

File Number:
190023109-009

Administrative Information

Subject:	1111 Officer needs help				
Date(s) and Time(s) of Occurrence Or Between:	//				
Location Of Occurrence:	Box Springs Bldg / Eastridge Ave RIVERSIDE				
Date/Time Reported:	8/12/2019 5:38:06 PM	Day:			
Date Of Report:	8/13/2019 3:49:11 AM	Type Of Premises:			
NPC:		RD:	PG08	Beat:	3
Was There a Witness To The Crime?					
Can a Suspect Be Named Or Identified?		By Whom?			
Can a Suspect Vehicle Be Identified?		By Whom?			

Code Section Classification:

Offense	Code Section
MURDER:FIRST DEGREE	187(A)
Completed	Yes

Records Section

Reporting Officer:	[REDACTED]		
115 Qualified:	Yes		
Send Copies Of This Report To:			
DOJ/NCIC Entered?		Name/ID	
DOJ/NCIC Cancelled?		Name/ID	
APR Sent?		Name/ID	
APB Sent?		Name/ID	

Public Narrative

Supplemental report.

Supervisor Approving

Approving Supervisor:	[REDACTED]
Date Reviewed:	8/13/2019 12:00:00 AM



Riverside Police Department

Officer Report

File Number:
190023109-009

Other Entities					
[REDACTED]	[REDACTED]	[REDACTED]	[REDACTED]	[REDACTED]	[REDACTED]
[REDACTED]	[REDACTED]	[REDACTED]	[REDACTED]	[REDACTED]	[REDACTED]
[REDACTED]	[REDACTED]	[REDACTED]	[REDACTED]	[REDACTED]	[REDACTED]
[REDACTED]	[REDACTED]	[REDACTED]	[REDACTED]	[REDACTED]	[REDACTED]
[REDACTED]	[REDACTED]	[REDACTED]	[REDACTED]	[REDACTED]	[REDACTED]
Notes:					

Witness Addresses:

Address Type	Address	City, State ZIP	County
[REDACTED]	[REDACTED]	[REDACTED]	[REDACTED]

Witness Phones:

[REDACTED]	[REDACTED]
[REDACTED]	[REDACTED]

Evidence Information			
Physical Evidence Present?		Physical Evidence Seized?	
Photographs Taken?		Photographer?	
Weapon Seized?		Weapon(s) Taken For Safety?	
Gang Related?		Sensitive Data?	
Fingerprint Search Made?		Fingerprints Obtained?	
Narcotics Seized?		Narcotics Field Tested?	
Audio Recording Available?		In Car Recording Available?	
Body Worn Camera Recording Available?			
Type of Weapon, Force, Or Device Used?			
Motive:			

Narrative

1 This following is a supplemental report. For further details, please see initial report.

2

3 **Narrative:**



Riverside Police Department

Officer Report

File Number:
190023109-009

4 On Monday, August 12, 2019, at approximately 1735 hours, I was assigned to
5 uniformed patrol for the City of Riverside Police Department. I received information from
6 RPD dispatch that an officer needed immediate assistance in the area of Box Springs
7 and Eastridge. I arrived on scene, activated my COBAN body-worn video system (BVS)
8 and assisted in setting a crime scene perimeter.

9
10 Shortly thereafter, I interviewed (O) [REDACTED]. The following is a synopsis of my
11 interview with him.

12 13 Statement of (O) [REDACTED]

14 I interviewed (O) [REDACTED] in Spanish. He stated at approximately 1730 hours he was
15 travelling eastbound on Eastridge Ave. towards the 215 freeway. He stated his radio
16 was loud and did not hear any noise from outside of his vehicle. He observed several
17 vehicles pull to the right side of the road in front of him. He turned his music down and
18 immediately heard shots fired from an unknown location. He heard an unknown subject,
19 in the driver's seat of a black Honda, tell him to pull over. (O) [REDACTED] pulled over and
20 observed S1 engaged in a gun fight with law enforcement. For his own safety he parked
21 his vehicle, reclined his seat and laid down to avoid being hit by gunfire. He stated he
22 heard 30-40 shots and felt as if they were travelling past his vehicle.

23
24 He observed a law enforcement officer tap on his window. The officer advised (O)
25 [REDACTED] to leave the premises and he obliged. (O) [REDACTED] left his vehicle (white,
26 Jeep) and stood by for further instruction.

27
28 (O) [REDACTED] was nervous and shaking. He appeared emotional but stated he did not
29 need medical aid.
30



Riverside Police Department

Officer Report

File Number:
190023109-010

Administrative Information

Subject:		1111 - OFFICER NEEDS BACK-UP/URGENT RESPONSE		
Date(s) and Time(s) of Occurrence Or Between:		//		
Location Of Occurrence:		Box Springs Bldg / Eastridge Ave RIVERSIDE		
Date/Time Reported:	8/12/2019 5:38:06 PM	Day:		
Date Of Report:	8/13/2019 3:56:44 AM	Type Of Premises:		
NPC:		RD:	PG08	Beat: 3
Was There a Witness To The Crime?				
Can a Suspect Be Named Or Identified?		By Whom?		
Can a Suspect Vehicle Be Identified?		By Whom?		

Code Section Classification:

Offense	Code Section
MURDER:FIRST DEGREE	187(A)
Completed	Yes

Records Section

Reporting Officer:	[REDACTED]		
115 Qualified:	Yes		
Send Copies Of This Report To:			
DOJ/NCIC Entered?		Name/ID	
DOJ/NCIC Cancelled?		Name/ID	
APR Sent?		Name/ID	
APB Sent?		Name/ID	

Public Narrative

I responded to an OIS.....

Supervisor Approving

Approving Supervisor:	[REDACTED]
Date Reviewed:	8/13/2019 12:00:00 AM



Riverside Police Department

Officer Report

File Number:
190023109-010

Witness Information

Code:		Name:	
Notes:			

Witness Addresses:

Witness Phones:

Evidence Information

Physical Evidence Present?		Physical Evidence Seized?	
Photographs Taken?		Photographer?	
Weapon Seized?		Weapon(s) Taken For Safety?	
Gang Related?		Sensitive Data?	
Fingerprint Search Made?		Fingerprints Obtained?	
Narcotics Seized?		Narcotics Field Tested?	
Audio Recording Available?		In Car Recording Available?	
Body Worn Camera Recording Available?			
Type of Weapon, Force, Or Device Used?			
Motive:			

Narrative

- 1 **The following is a supplemental report. Refer to initial report for further information.**
- 2
- 3 **Narrative:**



Riverside Police Department

Officer Report

File Number:
190023109-010

4 On Monday August 12, 2019 at approximately 1738 hours, RPD Dispatch broadcasted on the radio
5 that shots were fired on Box Springs and Eastridge, and a California Highway Patrol (CHP) Officer was
6 down. The text of the call stated a CHP Officer yelled over the radio he is in a gun fight and unknown
7 suspect information. Myself and several officers arrived on scene where the suspect was taken into
8 custody prior to my arrival. Along Eastridge there were several vehicles left by witnesses who ran to
9 safety during the incident. I contacted one of the witnesses, W1/ [REDACTED], who is the owner of a black
10 Honda Accord [REDACTED]). W1/ [REDACTED] provided me with the following statement.

11
12 **W1/ [REDACTED] Statement:**

13 W1/ [REDACTED] stated he was turning onto Eastridge from Box Springs when he saw a vehicle getting
14 towed on the east side of the street. He stated he saw the suspect pull out an AR-15 rifle and began
15 shooting at the CHP Officers who were behind the suspect. W1/ [REDACTED] then stopped his vehicle
16 and stayed parked in that position until additional Officers arrived and gun fire was no longer being
17 exchanged. W1/ [REDACTED] stated he saw an RPD Officer approach his vehicle from the right and
18 exchange fire with the suspect. W1/ [REDACTED] was unsure on the outcome of the suspect.

19
20 After myself and several officers were able to get witness statements, I assisted in a perimeter on the
21 south side of the intersection at Box Springs and Eastridge until relieved at 0300 hours (8/13/2019).

22
23 See initial report for further.

24 NFI.

25

RIVERSIDE POLICE DEPARTMENT



Riverside Police Department

Officer Report

File Number:
190023109-011

Administrative Information

Subject:		1111 - OFFICER NEEDS BACK-UP/URGENT RESPONSE			
Date(s) and Time(s) of Occurrence Or Between:		//			
Location Of Occurrence:		Box Springs Bldg / Eastridge Ave RIVERSIDE			
Date/Time Reported:	8/12/2019 5:38:06 PM	Day:			
Date Of Report:	8/13/2019 5:00:19 AM	Type Of Premises:			
NPC:		RD:	PG08	Beat:	3
Was There a Witness To The Crime?					
Can a Suspect Be Named Or Identified?		By Whom?			
Can a Suspect Vehicle Be Identified?		By Whom?			

Code Section Classification:

Offense	Code Section
ATTEMPTED MURDER	664/187(A)
Completed	Yes

Records Section

Reporting Officer:	[REDACTED]		
115 Qualified:	Yes		
Send Copies Of This Report To:			
DOJ/NCIC Entered?		Name/ID	
DOJ/NCIC Cancelled?		Name/ID	
APR Sent?		Name/ID	
APB Sent?		Name/ID	

Public Narrative

Supplemental Report:	
----------------------	--

Supervisor Approving

Approving Supervisor:	[REDACTED]
Date Reviewed:	8/13/2019 12:00:00 AM

Victim Information



Riverside Police Department

Officer Report

File Number:
190023109-011

PURSUANT TO CALIFORNIA PENAL CODE SECTION 293(a)/CONFIDENTIAL FORM(S) ATTACHED?:		
Code:		Name: [REDACTED]
Victim Type:	Individual	Will the victim prosecute?
[REDACTED]	[REDACTED]	[REDACTED]
[REDACTED]	[REDACTED]	[REDACTED]
[REDACTED]	[REDACTED]	[REDACTED]
[REDACTED]		

Victim Scars, Marks and Tattoos

Scar, Mark, Tattoo	Scar, Mark, Tattoo Location	Description
--------------------	-----------------------------	-------------

Victim Domestic Violence Information (If Applicable)

Emotional State:	Appearance:	Injuries:	Sobriety/Drug:
Victim Advised of Citizen's Arrest Rights?			
Victim Given "Alternatives To Domestic Violence" Card?			
Victim Given Agency Report Number?			
Victim Given Department Phone Number?			
Victim Advised Of Public Record/Privacy, 293(a) PC?			

Victim Vehicle Information:

Make	Model	Year	Color	License No.
------	-------	------	-------	-------------

Victim Injuries:

Injuries:	Apparent Minor Injury
If Treated For Injuries, By Whom?	RFD Station #4
If Hospitalized, Where?	
Date/Time:	
Nature of Injuries:	
Injury Weapons:	01 - Firearm (unknown whether handgun, rifle, or shotgun)

Victim Addresses:

Address Type	Address	City, State ZIP	County
Home	[REDACTED]	[REDACTED]	



Riverside Police Department

Officer Report

File Number:
190023109-011

Victim Phones:

Phone Type	Phone Number
Mobile	[REDACTED]

Victim Information

PURSUANT TO CALIFORNIA PENAL CODE SECTION 293(a)/CONFIDENTIAL FORM(S) ATTACHED?:

Code:	Name:
[REDACTED]	[REDACTED]

Victim Type:	Individual	Will the victim prosecute?
[REDACTED]	[REDACTED]	[REDACTED]

[REDACTED]	[REDACTED]	[REDACTED]	[REDACTED]	[REDACTED]	[REDACTED]
------------	------------	------------	------------	------------	------------

Height:	Weight:
[REDACTED]	[REDACTED]

Hair:	Eyes:
[REDACTED]	[REDACTED]

Notes:

Victim Scars, Marks and Tattoos

Scar, Mark, Tattoo	Scar, Mark, Tattoo Location	Description
--------------------	-----------------------------	-------------

Victim Domestic Violence Information (If Applicable)

Emotional State:	Appearance:	Injuries:	Sobriety/Drug:
[REDACTED]	[REDACTED]	[REDACTED]	[REDACTED]

Victim Advised of Citizen's Arrest Rights?

Victim Given "Alternatives To Domestic Violence" Card?

Victim Given Agency Report Number?

Victim Given Department Phone Number?

Victim Advised Of Public Record/Privacy, 293(a) PC?

Victim Vehicle Information:

Make	Model	Year	Color	License No.
[REDACTED]	[REDACTED]	[REDACTED]	[REDACTED]	[REDACTED]

Victim Injuries:

Injuries: None

If Treated For Injuries, By Whom?

If Hospitalized, Where?

Date/Time:

Nature of Injuries:



Riverside Police Department

Officer Report

File Number:
190023109-011

Injury Weapons:	01 - Firearm (unknown whether handgun, rifle, or shotgun)
-----------------	---

Victim Addresses:

Address Type	Address	City, State ZIP	County
Home			

Victim Phones:

Phone Type	Phone Number

Victim Information

PURSUANT TO CALIFORNIA PENAL CODE SECTION 293(a)/CONFIDENTIAL FORM(S) ATTACHED?:

Code:	Name:	
-------	-------	--

Victim Type:	Individual	Will the victim prosecute?
--------------	------------	----------------------------

Height:	Weight:
---------	---------

Hair:	Eyes:
-------	-------

Notes:

Victim Scars, Marks and Tattoos

Scar, Mark, Tattoo	Scar, Mark, Tattoo Location	Description

Victim Domestic Violence Information (If Applicable)

Emotional State:	Appearance:	Injuries:	Sobriety/Drug:
------------------	-------------	-----------	----------------

Victim Advised of Citizen's Arrest Rights?
--

Victim Given "Alternatives To Domestic Violence" Card?
--

Victim Given Agency Report Number?

Victim Given Department Phone Number?

Victim Advised Of Public Record/Privacy, 293(a) PC?

Victim Vehicle Information:

Make	Model	Year	Color	License No.

Victim Injuries:

Injuries:	None
-----------	------

If Treated For Injuries, By Whom?



Riverside Police Department

Officer Report

File Number:
190023109-011

If Hospitalized, Where?	
Date/Time:	
Nature of Injuries:	
Injury Weapons:	01 - Firearm (unknown whether handgun, rifle, or shotgun)

Victim Addresses:

Address Type	Address	City, State ZIP	County
Home			

Victim Phones:

Phone Type	Phone Number

Other Entities					
Name:					
Entity Type:	Other (Person)	Code:			
Sex:		Race:		DOB:	
Height:		Weight:			
Hair:		Eyes:			
Notes:					

Witness Addresses:

Address Type	Address	City, State ZIP	County
Home			

Witness Phones:

Phone Type	Phone Number
Mobile	

Other Entities					
Name:					
Entity Type:	Other (Person)	Code:			



Riverside Police Department

Officer Report

File Number:
190023109-011

Hair:	██████████	Eyes:	██████████
Notes:			

Witness Addresses:

Address Type	Address	City, State ZIP	County
Home	████████████████████	████████████████████	

Witness Phones:

Phone Type	Phone Number
Mobile	██████████████████

Evidence Information

Physical Evidence Present?		Physical Evidence Seized?	
Photographs Taken?	Yes	Photographer?	██████████████████
Weapon Seized?		Weapon(s) Taken For Safety?	No
Gang Related?	No	Sensitive Data?	No
Fingerprint Search Made?	No	Fingerprints Obtained?	No
Narcotics Seized?		Narcotics Field Tested?	No
Audio Recording Available?	No	In Car Recording Available?	No
Body Worn Camera Recording Available?	Yes		
Type of Weapon, Force, Or Device Used?			
Motive:			

Narrative

- 1 **Injuries:**
- 2 Several small lacerations to the right side of ██████████ face, chest, and right arm.
- 3
- 4 **Body-Worn Video System:**
- 5 I utilized my department issued Body-Worn Video System throughout the course of this
- 6 investigation.
- 7 **Narrative:**



Riverside Police Department

Officer Report

File Number:
190023109-011

8 On Monday, August 12, 2019, I was working as a uniformed Riverside Police Officer in the City
9 and County of Riverside, Ca. At this time, assisting officers were dispatched to the area of Box
10 Springs Blvd and Eastridge Avenue; reference an "11-11 shots fired, CHP Motor Officer down."

11 At approximately 1757 hours, the Riverside Police Department Communications center advised
12 there was a victim at 2221 Eastridge Avenue. I activated my overhead red and blue lights and
13 sirens at the intersection of Iowa Avenue and Blaine Street.

14 Upon my arrival, I contacted a female victim, who was verbally identified as [REDACTED]
15 [REDACTED] and her two sons were being treating by the Riverside Fire Department
16 (RFD) Engine #4. The following is a summary of [REDACTED] statement.

17 [REDACTED] stated she had just left West Coast Spine at 6177 River Crest Drive Unit #A and had
18 her two twins sons seated in the rear passenger seat. [REDACTED] made a left turn onto Eastridge
19 Avenue from Box Springs Road. While driving in the #2 lane on Eastridge Avenue she saw a
20 tow truck in front of her make a U-turn and signaled for her to stop. As she stopped her vehicle a
21 single bullet went through her front windshield. The bullet missed her head, and landed in
22 between her two children missing them.

23 [REDACTED] ducked her head, told her children to get down, reached behind her, and unbuckled
24 their seatbelts. A male, later identified as [REDACTED], was in the vehicle directly behind
25 her. [REDACTED] ran up to [REDACTED] vehicle, pulled the children out, and brought them to the
26 rear of his vehicle. [REDACTED] once again went to [REDACTED] vehicle and assisted her in getting
27 out. [REDACTED] grabbed [REDACTED] and her children and ran west on Eastridge Avenue.
28 [REDACTED] stated during the ordeal she heard several shots fired.

29 I next spoke with [REDACTED]; the following is a summary of his statement.

30 [REDACTED] stated he was driving east on Eastridge Avenue in the #2 lane, when he heard
31 approximately 12-15 gunshots coming from the top side of the bridge. [REDACTED] immediately
32 exited his vehicle, ran up to the silver Toyota Corolla and pulled two children out from the back
33 seat. [REDACTED] then retreated behind his vehicle, left the two children, and once again ran up to
34 the Toyota Corolla. [REDACTED] assisted a female exit the driver seat, and ran behind his vehicle.
35 [REDACTED], the two children, and the female then ran east on Eastridge Avenue.

36 Prior to my arrival, [REDACTED] stated RFD had wiped her face clean as she had sustained
37 several small lacerations across her face and chest. I photographed [REDACTED] and later
38 downloaded them into the DIMS database.

39 After victim's statements were gathered, Sergeant [REDACTED] instructed for assisting officers and I
40 to maintain a perimeter at the intersection of Eastridge Avenue and Box Springs Boulevard until
41 relieved at 0300 on August 13, 2019.

42

43

Date Printed: 10/19/2022 9:20 AM	Case Report Number: 190023109-011	Page: 7 of 8	Ver. 1.3.3
-------------------------------------	--------------------------------------	-----------------	---------------



Riverside Police Department Officer Report

File Number:
190023109-011

44

RIVERSIDE POLICE DEPARTMENT

Date Printed: 10/19/2022 9:20 AM	Case Report Number: 190023109-011	Page: 8 of 8	Ver. 1.3.3
--	---	------------------------	----------------------



Riverside Police Department

Officer Report

File Number:
190023109-012

Administrative Information

Subject:		1111 - OFFICER NEEDS BACK-UP/URGENT RESPONSE			
Date(s) and Time(s) of Occurrence Or Between:		//			
Location Of Occurrence:		Box Springs Bldg / Eastridge Ave RIVERSIDE			
Date/Time Reported:	8/12/2019 5:38:06 PM	Day:			
Date Of Report:	8/13/2019 10:14:31 AM	Type Of Premises:			
NPC:		RD:	PG08	Beat:	3
Was There a Witness To The Crime?					
Can a Suspect Be Named Or Identified?		By Whom?			
Can a Suspect Vehicle Be Identified?		By Whom?			

Code Section Classification:

Records Section

Reporting Officer:	[REDACTED]				
115 Qualified:	Yes				
Send Copies Of This Report To:					
DOJ/NCIC Entered?		Name/ID			
DOJ/NCIC Cancelled?		Name/ID			
APR Sent?		Name/ID			
APB Sent?		Name/ID			

Public Narrative

Supervisor Approving

Approving Supervisor:	[REDACTED]				
Date Reviewed:	8/13/2019 12:00:00 AM				

Evidence Information

Physical Evidence Present?		Physical Evidence Seized?	
----------------------------	--	---------------------------	--



Riverside Police Department

Officer Report

File Number:
190023109-012

Photographs Taken?		Photographer?	
Weapon Seized?		Weapon(s) Taken For Safety?	
Gang Related?		Sensitive Data?	
Fingerprint Search Made?		Fingerprints Obtained?	
Narcotics Seized?		Narcotics Field Tested?	
Audio Recording Available?		In Car Recording Available?	
Body Worn Camera Recording Available?			
Type of Weapon, Force, Or Device Used?			
Motive:			

Narrative

- 1 On August 13, 2019, partner Officer [REDACTED] and I were working uniformed patrol in the City and
- 2 County of Riverside. At approximately 0225 hours we responded to Sycamore Canyon and Eastridge
- 3 Av, to assist with scene containment on the officer involved shooting.
- 4 I contacted Sgt. [REDACTED] who asked us to block of the intersection of Box Springs Blvd and Eastridge
- 5 Av to ensure no unauthorized personnel entered the scene.
- 6 While blocking the intersection I was flagged down by W/ [REDACTED] who stated she was a witness to
- 7 the shooting.
- 8 W/ [REDACTED] stated she was at work [REDACTED], when she heard two gunshots. W/ [REDACTED]
- 9 stated she then closed the business and started to drive home. As she was driving she saw a male
- 10 wearing black holding a rifle and pointing it towards a CHP unit. W/ [REDACTED] stated she did not see a
- 11 CHP officer or hear any additional gun shots. W/ [REDACTED] stated the suspect was pacing back and
- 12 forth in front of his car and decided to turn around and go the other way.
- 13 W/ [REDACTED] stated her business did not have video surveillance of the incident.
- 14 I remained on scene blocking Eastridge and Box Springs until relieved by Officer [REDACTED] and Officer
- 15 [REDACTED]
- 16 [REDACTED]



Riverside Police Department

Officer Report

File Number:
190023109-013

Administrative Information

Subject:		1111 - OFFICER NEEDS BACK-UP/URGENT RESPONSE			
Date(s) and Time(s) of Occurrence Or Between:		//			
Location Of Occurrence:		Box Springs Bldg / Eastridge Ave RIVERSIDE			
Date/Time Reported:	8/12/2019 5:38:06 PM	Day:			
Date Of Report:	8/13/2019 12:21:32 PM	Type Of Premises:			
NPC:		RD:	PG08	Beat:	3
Was There a Witness To The Crime?					
Can a Suspect Be Named Or Identified?		By Whom?			
Can a Suspect Vehicle Be Identified?		By Whom?			

Code Section Classification:

Records Section

Reporting Officer:	[REDACTED]				
115 Qualified:	Yes				
Send Copies Of This Report To:					
DOJ/NCIC Entered?		Name/ID			
DOJ/NCIC Cancelled?		Name/ID			
APR Sent?		Name/ID			
APB Sent?		Name/ID			

Public Narrative

Supervisor Approving

Approving Supervisor:	[REDACTED]				
Date Reviewed:	8/20/2019 12:00:00 AM				

Evidence Information

Physical Evidence Present?		Physical Evidence Seized?	
----------------------------	--	---------------------------	--



Riverside Police Department

Officer Report

File Number:
190023109-013

Photographs Taken?		Photographer?	
Weapon Seized?		Weapon(s) Taken For Safety?	
Gang Related?		Sensitive Data?	
Fingerprint Search Made?		Fingerprints Obtained?	
Narcotics Seized?		Narcotics Field Tested?	
Audio Recording Available?		In Car Recording Available?	
Body Worn Camera Recording Available?			
Type of Weapon, Force, Or Device Used?			
Motive:			

Narrative

1 **Source:**

2 On Monday, 8-12-19, at approx. 1738 hours, partner Officer [REDACTED] and I were
 3 dispatched to the area of Eastridge Ave and Box Springs to assist the California Highway Patrol
 4 (CHP). Their Officers were involved in an active gun fight and were requesting assistance.
 5 Officer [REDACTED] and I are assigned to the Riverside Police Aviation Unit. I was the pilot and
 6 Officer [REDACTED] was the Tactical Flight Officer (TFO). We were flying a MD 500 Helicopter, tail
 7 number N911RP.

8
 9 **Details:**

10 While enroute to the location, we were told that the suspect had a high powered rifle and
 11 we should climb to a higher altitude to avoid the gun fire. When we arrived, Officer [REDACTED]
 12 located the incident on our on board camera system. I was also looking at the camera monitor
 13 and saw a subject lying on his back to the front of a white truck. That subject had what
 14 appeared to be a rifle lying across his waist area. Officer [REDACTED] then panned the camera to
 15 the rear of the white truck and I saw a CHP Officer lying face down near the right rear portion of
 16 the truck. I immediately decided to land the helicopter on the Eastridge Ave. overpass bridge
 17 to possibly perform an officer rescue of the downed CHP Officer.

18 Approx. 6 months ago, the entire Aviation Unit trained this exact maneuver in case we ever
 19 needed to rescue someone. Before I landed, Officer [REDACTED] told me he was already unbuckled
 20 and was going to assist rescuing the Officer. I landed on the E/B lanes of Eastridge Ave. approx.
 21 150'-200' east of the incident. Officer [REDACTED] ran from the helicopter to help the downed
 22 Officer. Within seconds, four unknown Officers were carrying the CHP Officer toward the



Riverside Police Department

Officer Report

File Number:
190023109-013

23 helicopter. They placed the CHP Officer in the rear portion of the helicopter and Officer [REDACTED]
24 got in back with him covering himself over the CHP Officer. I then took off toward what I called
25 RCRMC (it is now called RUHS). I advised dispatch to let the medical staff know that we were
26 enroute with a downed Officer.

27 I landed on the helipad just outside the entrance to the Emergency Room. A medical staff
28 member along with several Riverside County Sheriff Deputies assisted Officer [REDACTED] remove
29 the CHP Officer from the helicopter. They took him inside the Emergency Room to render aid.
30 The inside rear portion and a small portion to the inside front of the helicopter had the Officer's
31 blood on it. I knew the helicopter was now going to be apart of the crime scene. We locked
32 down the helicopter for evidence techs to arrive. A short time later Lt. [REDACTED] arrived
33 and arranged transportation for Officer [REDACTED] and myself to our Magnolia Station. Sgt. [REDACTED]
34 transported us to the Magnolia Station for possible Detective Interviews.

35

36

RIVERSIDE POLICE DEPARTMENT

Date Printed: 10/19/2022 9:21 AM	Case Report Number: 190023109-013	Page: 3 of 3	Ver. 1.3.3
-------------------------------------	--------------------------------------	-----------------	---------------



Riverside Police Department

Officer Report

File Number:
190023109-014

Administrative Information

Subject:	1111 - OFFICER NEEDS BACK-UP/URGENT RESPONSE				
Date(s) and Time(s) of Occurrence Or Between:	//				
Location Of Occurrence:	Box Springs Bldg / Eastridge Ave RIVERSIDE				
Date/Time Reported:	8/12/2019 5:38:06 PM	Day:			
Date Of Report:	8/13/2019 12:20:24 PM	Type Of Premises:			
NPC:		RD:	PG08	Beat:	3
Was There a Witness To The Crime?					
Can a Suspect Be Named Or Identified?			By Whom?		
Can a Suspect Vehicle Be Identified?			By Whom?		

Code Section Classification:

Records Section

Reporting Officer:	[REDACTED]		
115 Qualified:	Yes		
Send Copies Of This Report To:			
DOJ/NCIC Entered?		Name/ID	
DOJ/NCIC Cancelled?		Name/ID	
APR Sent?		Name/ID	
APB Sent?		Name/ID	

Public Narrative

Supplemental Report for my actions on this incident

Supervisor Approving

Approving Supervisor:	[REDACTED]
Date Reviewed:	8/20/2019 12:00:00 AM

Evidence Information

Physical Evidence Present?		Physical Evidence Seized?	
----------------------------	--	---------------------------	--



Riverside Police Department

Officer Report

File Number:
190023109-014

Photographs Taken?		Photographer?	
Weapon Seized?		Weapon(s) Taken For Safety?	
Gang Related?		Sensitive Data?	
Fingerprint Search Made?		Fingerprints Obtained?	
Narcotics Seized?		Narcotics Field Tested?	
Audio Recording Available?		In Car Recording Available?	
Body Worn Camera Recording Available?			
Type of Weapon, Force, Or Device Used?			
Motive:			

Narrative

- 1 Narrative:
- 2 On 08-12-2019 at about 1739 hrs, I heard a call for officer needs help at Eastridge/I-215. I was at Van
- 3 Buren/King and responded lights and siren on my motor. I arrived on scene at Box Springs/Eastridge
- 4 at about 1749 hrs. I saw Officer K. Feimer walking W/B on Eastridge toward my location at which time
- 5 he told me he was involved in an Officer Involved Shooting. He told me he was not injured and said
- 6 the suspect was shooting back at him in a south westerly direction. I then saw Officer [REDACTED] and told
- 7 him to go with me to the buildings S/W of our location and look for victims or bullet strikes. We did
- 8 not find any victims or bullet strikes.
- 9
- 10 I then helped establish the crime scene by putting up crime scene tape and holding my position to
- 11 control people in and out of the scene at the intersection of Eastridge/Box Springs. I stayed at the
- 12 location until about 2300 hrs when Sgt [REDACTED] told me to leave. I then went off duty.
- 13



Riverside Police Department

Officer Report

File Number:
190023109-015

Administrative Information

Subject:	1111 - OFFICER NEEDS BACK-UP/URGENT RESPONSE				
Date(s) and Time(s) of Occurrence Or Between:	//				
Location Of Occurrence:	Box Springs Bldg / Eastridge Ave RIVERSIDE				
Date/Time Reported:	8/12/2019 5:38:06 PM	Day:			
Date Of Report:	8/13/2019 12:36:15 PM	Type Of Premises:			
NPC:		RD:	PG08	Beat:	3
Was There a Witness To The Crime?					
Can a Suspect Be Named Or Identified?		By Whom?			
Can a Suspect Vehicle Be Identified?		By Whom?			

Code Section Classification:

Records Section

Reporting Officer:	[REDACTED]		
115 Qualified:	Yes		
Send Copies Of This Report To:			
DOJ/NCIC Entered?		Name/ID	
DOJ/NCIC Cancelled?		Name/ID	
APR Sent?		Name/ID	
APB Sent?		Name/ID	

Public Narrative

I assisted with scene control at the intersection of Box Springs/Eastridge for an OIS.

Supervisor Approving

Approving Supervisor:	[REDACTED]
Date Reviewed:	8/15/2019 12:00:00 AM

Evidence Information

Physical Evidence Present?		Physical Evidence Seized?	
----------------------------	--	---------------------------	--



Riverside Police Department

Officer Report

File Number:
190023109-015

Photographs Taken?		Photographer?	
Weapon Seized?		Weapon(s) Taken For Safety?	
Gang Related?		Sensitive Data?	
Fingerprint Search Made?		Fingerprints Obtained?	
Narcotics Seized?		Narcotics Field Tested?	
Audio Recording Available?		In Car Recording Available?	
Body Worn Camera Recording Available?			
Type of Weapon, Force, Or Device Used?			
Motive:			

Narrative

- 1 On 08/12/19, at about 1738 hours, I was in the area of Woodcrest, when I heard the call of an 11-11
- 2 broadcast for CHP at Eastridge and the 215 Frwy. I responded Code 3 on my department motorcycle
- 3 and arrive at the scene at about 1749. Just prior to arriving at the scene, I heard that the suspect was
- 4 down. I took up a traffic/crime scene control position at the intersection of Box Springs and
- 5 Eastridge. I stayed there until Sgt. [REDACTED] relieved me at about 2300 hours.
- 6



Riverside Police Department

Officer Report

File Number:
190023109-016

Administrative Information

Subject:	1111 - OFFICER NEEDS BACK-UP/URGENT RESPONSE				
Date(s) and Time(s) of Occurrence Or Between:	//				
Location Of Occurrence:	Box Springs Bldg / Eastridge Ave RIVERSIDE				
Date/Time Reported:	8/12/2019 5:38:06 PM	Day:			
Date Of Report:	8/13/2019 12:39:33 PM	Type Of Premises:			
NPC:		RD:	PG08	Beat:	3
Was There a Witness To The Crime?					
Can a Suspect Be Named Or Identified?		By Whom?			
Can a Suspect Vehicle Be Identified?		By Whom?			

Code Section Classification:

Records Section

Reporting Officer:	[REDACTED]		
115 Qualified:	Yes		
Send Copies Of This Report To:			
DOJ/NCIC Entered?		Name/ID	
DOJ/NCIC Cancelled?		Name/ID	
APR Sent?		Name/ID	
APB Sent?		Name/ID	

Public Narrative

Supervisor Approving

Approving Supervisor:	[REDACTED]
Date Reviewed:	8/15/2019 12:00:00 AM

Evidence Information

Physical Evidence Present?		Physical Evidence Seized?	
----------------------------	--	---------------------------	--



Riverside Police Department

Officer Report

File Number:
190023109-016

Photographs Taken?		Photographer?	
Weapon Seized?		Weapon(s) Taken For Safety?	
Gang Related?		Sensitive Data?	
Fingerprint Search Made?		Fingerprints Obtained?	
Narcotics Seized?		Narcotics Field Tested?	
Audio Recording Available?		In Car Recording Available?	
Body Worn Camera Recording Available?			
Type of Weapon, Force, Or Device Used?			
Motive:			

Narrative

- 1 On Monday, August 12, 2019, about 1739 hours I was dispatched to a call of an 11-11 (Emergency
- 2 back up) for California Highway Patrol in the area of Eastridge and Box Springs Riverside, CA. Shots
- 3 were being fired at the officers and one was down. I responded from the area of Van Buren and
- 4 King, Code 3 (Lights and Sirens) and arrived on scene about 1749 hours. Upon arrival the suspect
- 5 was down and I took a perimeter post at Eastridge and Box Springs. I was relieved from my post at
- 6 approximately 2300 hours.
- 7 Nothing Further.
- 8



Riverside Police Department

Officer Report

File Number:
190023109-017

Administrative Information

Subject: 1111 - OFFICER NEEDS BACK-UP/URGENT RESPONSE				
Date(s) and Time(s) of Occurrence Or Between:		8/13/2019 5:39:00 PM //		
Location Of Occurrence:		Box Springs Bldg / Eastridge Ave RIVERSIDE		
Date/Time Reported:	8/12/2019 5:38:06 PM	Day:	Tuesday	
Date Of Report:	8/13/2019 2:00:34 PM	Type Of Premises:		
NPC:		RD:	PG08	Beat: 3
Was There a Witness To The Crime?				
Can a Suspect Be Named Or Identified?		By Whom?		
Can a Suspect Vehicle Be Identified?		By Whom?		

Code Section Classification:

Offense	Code Section
MURDER:FIRST DEGREE	187(A)
Completed	Yes

Records Section

Reporting Officer:	[REDACTED]		
115 Qualified:	Yes		
Send Copies Of This Report To:			
DOJ/NCIC Entered?		Name/ID	
DOJ/NCIC Cancelled?		Name/ID	
APR Sent?		Name/ID	
APB Sent?		Name/ID	

Public Narrative

Officer Involved Shooting

Supervisor Approving

Approving Supervisor:	[REDACTED]
Date Reviewed:	8/15/2019 12:00:00 AM



Riverside Police Department

Officer Report

File Number:
190023109-017

Evidence Information

Physical Evidence Present?		Physical Evidence Seized?	
Photographs Taken?		Photographer?	
Weapon Seized?		Weapon(s) Taken For Safety?	
Gang Related?		Sensitive Data?	
Fingerprint Search Made?		Fingerprints Obtained?	
Narcotics Seized?		Narcotics Field Tested?	
Audio Recording Available?		In Car Recording Available?	
Body Worn Camera Recording Available?			
Type of Weapon, Force, Or Device Used?			
Motive:			

Narrative

- 1 Source of Activity:
- 2 On 8/12/2019, at about 1738 hours I responded to a radio call of an 11-11 request for the California
- 3 Highway Patrol, in the area of Eastridge Avenue and Box Springs, in the City and County of Riverside.
- 4 While enroute to the scene dispatch advised there was a motor officer down and shots could still be
- 5 heard being fired by dispatch. Based on the previous I activated my overhead lights and siren and
- 6 responded to the scene.
- 7
- 8 Upon my arrival, I began setting up crime scene tape on the east portion of the perimeter, on the
- 9 southbound 215 exit and Eastridge Avenue. I also assisted in searching Eastridge Avenue for any
- 10 evidence, outside of the main crime scene. The search took place from the area of Eastridge and Box
- 11 Springs Blvd and continued east. The search stopped about 50 yards west of the main crime scene. I
- 12 did not locate any evidence during the search.
- 13
- 14 Nothing further to report.
- 15



Riverside Police Department

Officer Report

File Number:
190023109-018

Administrative Information

Subject:		1111 - OFFICER NEEDS BACK-UP/URGENT RESPONSE			
Date(s) and Time(s) of Occurrence Or Between:		//			
Location Of Occurrence:		Box Springs Bldg / Eastridge Ave RIVERSIDE			
Date/Time Reported:	8/12/2019 5:38:06 PM	Day:			
Date Of Report:	8/13/2019 2:52:56 PM	Type Of Premises:			
NPC:		RD:	PG08	Beat:	3
Was There a Witness To The Crime?					
Can a Suspect Be Named Or Identified?		By Whom?			
Can a Suspect Vehicle Be Identified?		By Whom?			

Code Section Classification:

Records Section

Reporting Officer:	[REDACTED]				
115 Qualified:	Yes				
Send Copies Of This Report To:					
DOJ/NCIC Entered?		Name/ID			
DOJ/NCIC Cancelled?		Name/ID			
APR Sent?		Name/ID			
APB Sent?		Name/ID			

Public Narrative

Supervisor Approving

Approving Supervisor:	[REDACTED]				
Date Reviewed:	8/20/2019 12:00:00 AM				

Evidence Information

Physical Evidence Present?		Physical Evidence Seized?	
----------------------------	--	---------------------------	--



Riverside Police Department

Officer Report

File Number:
190023109-018

Photographs Taken?		Photographer?	
Weapon Seized?		Weapon(s) Taken For Safety?	
Gang Related?		Sensitive Data?	
Fingerprint Search Made?		Fingerprints Obtained?	
Narcotics Seized?		Narcotics Field Tested?	
Audio Recording Available?		In Car Recording Available?	
Body Worn Camera Recording Available?			
Type of Weapon, Force, Or Device Used?			
Motive:			

Narrative

1 **Source**

2 On Monday, August 12, 2019 I was working as a Tactical Flight Officer (TFO) in the aviation
3 unit for the Riverside Police Department. At about 1740 hours, Partner Officer [REDACTED] and I
4 received a call of a Highway Patrol Officer needing assistance. The Highway Patrol Officer was
5 in an active gun battle with a suspect. Police Pilot [REDACTED] and I responded to the scene from the
6 Aviation facility.

7
8 **Narrative:**

9 When we arrived on scene, I was able to locate the crime scene on the FLIR camera system that
10 is affixed to the aircraft. I was able to see a pickup truck, and a subject laying on the ground at
11 the front passenger side of the truck. The subject was lying on his back, and I could see what
12 appeared to be a rifle across his torso. I notified dispatch and ground units of the subject, and
13 what I was seeing. I then switched to CHP frequency and notified them of the same traffic.

14
15 After locating what appeared to the subject, I moved to the camera to scan for any additional
16 threats. As I moved the camera to the rear of the pick up truck, I could see another male wearing
17 an all tan uniform lying on the ground. Ofc [REDACTED] and I both saw this immediately and identified
18 the male an officer that was down and needed assistance. We immediately made the decision to
19 land and lend assistance to the downed officer. Ofc [REDACTED] landed the helicopter on Eastridge
20 about 100 to 150 feet behind the pickup truck. While landing, I notified our dispatch and CHP
21 dispatch that we were landing in the street to airlift the officer to the hospital. As soon as we
22 landed, I exited the aircraft and ran to where the down officer was. There was a ground team
23 that moved up on the officer from the rear and provided cover. The ground units picked the
24 officer up and I escorted them back to the helicopter. We approached the helicopter on the right
25 side and the ground units involved hoisted the injured officer into the back of the helicopter. I
26 then repositioned myself on the left side of the helicopter and pulled the injured officer through,
27 so he was lying on his back on the floor of the aircraft. I climbed inside the backseat of the



Riverside Police Department

Officer Report

File Number:
190023109-018

28 aircraft, on top of the injured officer, and I signaled for Ofc [REDACTED] that we inside the aircraft and
29 ready to depart.

30
31 Ofc [REDACTED] departed from the street where we landed, and began to fly towards RUHS. During the
32 flight, I remained in the back of the helicopter with the injured officer hold onto him so we did
33 not fall out of the aircraft. I could see he had a bullet wound to one of his forearms, and another
34 bullet hole in the front right part of his motor helmet. Once we landed at RUHS, I exited the
35 aircraft and signaled for medical staff to come and assist us. Medical staff brought a gurney out
36 to the aircraft and we removed the officer from the back floor of the aircraft. He was then rushed
37 into the emergency room by waiting medical staff and law enforcement.

38
39 We then downed the aircraft for evidence, and were transported to the Magnolia station for
40 processing.

41
42
43

RIVERSIDE POLICE DEPARTMENT

Date Printed: 10/19/2022 9:24 AM	Case Report Number: 190023109-018	Page: 3 of 3	Ver. 1.3.3
-------------------------------------	--------------------------------------	-----------------	---------------



Riverside Police Department

Officer Report

File Number:
190023109-019

Administrative Information

Subject:		1111 - OFFICER NEEDS BACK-UP/URGENT RESPONSE			
Date(s) and Time(s) of Occurrence Or Between:		8/13/2019 5:00:00 AM // 8/13/2019 4:00:00 PM			
Location Of Occurrence:		Box Springs Bldg / Eastridge Ave RIVERSIDE			
Date/Time Reported:	8/12/2019 5:38:06 PM	Day:	Tuesday		
Date Of Report:	8/13/2019 4:00:26 PM	Type Of Premises:			
NPC:		RD:	PG08	Beat:	3
Was There a Witness To The Crime?					
Can a Suspect Be Named Or Identified?		By Whom?			
Can a Suspect Vehicle Be Identified?		By Whom?			

Code Section Classification:

Records Section

Reporting Officer:	[REDACTED]				
115 Qualified:	Yes				
Send Copies Of This Report To:					
DOJ/NCIC Entered?		Name/ID			
DOJ/NCIC Cancelled?		Name/ID			
APR Sent?		Name/ID			
APB Sent?		Name/ID			

Public Narrative

Supervisor Approving

Approving Supervisor:	[REDACTED]				
Date Reviewed:	8/20/2019 12:00:00 AM				

Evidence Information

Physical Evidence Present?		Physical Evidence Seized?	
----------------------------	--	---------------------------	--



Riverside Police Department

Officer Report

File Number:
190023109-019

Photographs Taken?		Photographer?	
Weapon Seized?		Weapon(s) Taken For Safety?	
Gang Related?		Sensitive Data?	
Fingerprint Search Made?		Fingerprints Obtained?	
Narcotics Seized?		Narcotics Field Tested?	
Audio Recording Available?		In Car Recording Available?	
Body Worn Camera Recording Available?			
Type of Weapon, Force, Or Device Used?			
Motive:			

Narrative

- 1 On August 13, 2019, partner Officer [REDACTED] and I were working uniformed patrol in the City and
- 2 County of Riverside. At approximately 0500 hours we responded to Sycamore Canyon and Eastridge
- 3 Av, to assist with scene containment on the officer involved shooting.
- 4 I contacted Sgt. [REDACTED] who asked us to block of the intersection of Box Springs Blvd and Fair Isle
- 5 Dr. to ensure no unauthorized personnel entered the scene.
- 6 Officer [REDACTED] and I remained on scene blocking Eastridge and Box Springs until relieved by
- 7 Officer [REDACTED] and Officer [REDACTED].
- 8



Riverside Police Department

Officer Report

File Number:
190023109-020

Administrative Information

Subject:	1111 - OFFICER NEEDS BACK-UP/URGENT RESPONSE				
Date(s) and Time(s) of Occurrence Or Between:	//				
Location Of Occurrence:	Box Springs Bldg / Eastridge Ave RIVERSIDE				
Date/Time Reported:	8/12/2019 5:38:06 PM	Day:			
Date Of Report:	8/13/2019 4:23:32 PM	Type Of Premises:			
NPC:		RD:	PG08	Beat:	3
Was There a Witness To The Crime?					
Can a Suspect Be Named Or Identified?			By Whom?		
Can a Suspect Vehicle Be Identified?			By Whom?		

Code Section Classification:

Records Section

Reporting Officer:	[REDACTED]		
115 Qualified:	Yes		
Send Copies Of This Report To:			
DOJ/NCIC Entered?		Name/ID	
DOJ/NCIC Cancelled?		Name/ID	
APR Sent?		Name/ID	
APB Sent?		Name/ID	

Public Narrative

On 08-13-2019 I was called in to assist in securing the crime scene perimeter.

Supervisor Approving

Approving Supervisor:	[REDACTED]
Date Reviewed:	8/18/2019 12:00:00 AM

Evidence Information

Physical Evidence Present?		Physical Evidence Seized?	
----------------------------	--	---------------------------	--



Riverside Police Department

Officer Report

File Number:
190023109-020

Photographs Taken?		Photographer?	
Weapon Seized?		Weapon(s) Taken For Safety?	
Gang Related?		Sensitive Data?	
Fingerprint Search Made?		Fingerprints Obtained?	
Narcotics Seized?		Narcotics Field Tested?	
Audio Recording Available?		In Car Recording Available?	
Body Worn Camera Recording Available?			
Type of Weapon, Force, Or Device Used?			
Motive:			

Narrative

1 **DETAIL:**

2 On Tuesday, August 13th, 2019, Partner Officer [REDACTED] and I (Officer [REDACTED]), were in
3 full police uniform and driving a marked Riverside Police vehicle. At approximately 0500 hours, at the
4 direction of Lt. [REDACTED] we responded to the intersection of Eastridge Avenue and Sycamore Canyon
5 Boulevard (In the City and County of Riverside). We contacted Sgt. [REDACTED] and were assigned to the
6 intersection of Eastridge Avenue and Valley Springs Parkway for scene preservation. Officer [REDACTED]
7 and I maintained our position until relieved by K-9 Officer [REDACTED]
8 Nothing Further.
9



Riverside Police Department

Officer Report

File Number:
190023109-021

Administrative Information

Subject:		1111 - OFFICER NEEDS BACK-UP/URGENT RESPONSE			
Date(s) and Time(s) of Occurrence Or Between:		8/13/2019 8:30:00 AM // 8/13/2019 2:30:00 PM			
Location Of Occurrence:		Box Springs Bldg / Eastridge Ave RIVERSIDE			
Date/Time Reported:	8/12/2019 5:38:06 PM	Day:	Tuesday		
Date Of Report:	8/13/2019 4:28:33 PM	Type Of Premises:			
NPC:		RD:	PG08	Beat:	3
Was There a Witness To The Crime?					
Can a Suspect Be Named Or Identified?		By Whom?			
Can a Suspect Vehicle Be Identified?		By Whom?			

Code Section Classification:

Records Section

Reporting Officer:	[REDACTED]				
115 Qualified:	Yes				
Send Copies Of This Report To:					
DOJ/NCIC Entered?		Name/ID			
DOJ/NCIC Cancelled?		Name/ID			
APR Sent?		Name/ID			
APB Sent?		Name/ID			

Public Narrative

Supplemental Report.

Supervisor Approving

Approving Supervisor:	[REDACTED]				
Date Reviewed:	8/15/2019 12:00:00 AM				

Evidence Information

Physical Evidence Present?		Physical Evidence Seized?	
----------------------------	--	---------------------------	--



Riverside Police Department

Officer Report

File Number:
190023109-021

Photographs Taken?		Photographer?	
Weapon Seized?		Weapon(s) Taken For Safety?	
Gang Related?		Sensitive Data?	
Fingerprint Search Made?		Fingerprints Obtained?	
Narcotics Seized?		Narcotics Field Tested?	
Audio Recording Available?		In Car Recording Available?	
Body Worn Camera Recording Available?			
Type of Weapon, Force, Or Device Used?			
Motive:			

Narrative

- 1 **Evidence:**
- 2 Video Files DJI_0007 through DJI_0030 - Downloaded to the Drone Video folder on the
- 3 BWC/Coban server. (\\rpd-bwc-coban\drone_Videos\)
- 4 **Notification:**
- 5 On 08/13/19 at about 0830 I responded to the Command Post located at Sycamore Canyon and
- 6 Eastridge to assist Detectives with areal footage of the crime scene. Detective [REDACTED] assisted with the
- 7 Unmanned Arial System (Drone) operation. During multiple flights, the above video files were
- 8 collected and stored for evidence. Detective [REDACTED] and I cleared the scene at about 1430 without
- 9 incident.
- 10 NFI.
- 11



Riverside Police Department

Officer Report

File Number:
190023109-022

Administrative Information

Subject:	1111 - OFFICER NEEDS BACK-UP/URGENT RESPONSE				
Date(s) and Time(s) of Occurrence Or Between:	//				
Location Of Occurrence:	Box Springs Bldg / Eastridge Ave RIVERSIDE				
Date/Time Reported:	8/12/2019 5:38:06 PM	Day:			
Date Of Report:	8/13/2019 4:50:15 PM	Type Of Premises:			
NPC:		RD:	PG08	Beat:	3
Was There a Witness To The Crime?					
Can a Suspect Be Named Or Identified?		By Whom?			
Can a Suspect Vehicle Be Identified?		By Whom?			

Code Section Classification:

Records Section

Reporting Officer:	[REDACTED]		
115 Qualified:	Yes		
Send Copies Of This Report To:			
DOJ/NCIC Entered?		Name/ID	
DOJ/NCIC Cancelled?		Name/ID	
APR Sent?		Name/ID	
APB Sent?		Name/ID	

Public Narrative

On 08-13-19, at approximately 0225 hours, partner Officer [REDACTED] and I were working uniformed patrol in the City/County of Riverside. We responded to Box Springs Blvd and Eastridge Av, to assist in the investigation. See narrative for further information.

Supervisor Approving

Approving Supervisor:	[REDACTED]
Date Reviewed:	8/13/2019 12:00:00 AM

Other Entities



Riverside Police Department

Officer Report

File Number:
190023109-022

Name:	[REDACTED]				
[REDACTED]	[REDACTED]	[REDACTED]	[REDACTED]	[REDACTED]	[REDACTED]
[REDACTED]	[REDACTED]	[REDACTED]	[REDACTED]	[REDACTED]	[REDACTED]
[REDACTED]	[REDACTED]	[REDACTED]	[REDACTED]	[REDACTED]	[REDACTED]
[REDACTED]	[REDACTED]	[REDACTED]	[REDACTED]	[REDACTED]	[REDACTED]
[REDACTED]	[REDACTED]				

Witness Addresses:

Address Type	Address	City, State ZIP	County
[REDACTED]	[REDACTED]	[REDACTED]	[REDACTED]

Witness Phones:

[REDACTED]	[REDACTED]
[REDACTED]	[REDACTED]

Evidence Information

Physical Evidence Present?		Physical Evidence Seized?	
Photographs Taken?		Photographer?	
Weapon Seized?		Weapon(s) Taken For Safety?	
Gang Related?		Sensitive Data?	
Fingerprint Search Made?		Fingerprints Obtained?	
Narcotics Seized?		Narcotics Field Tested?	
Audio Recording Available?		In Car Recording Available?	
Body Worn Camera Recording Available?			
Type of Weapon, Force, Or Device Used?			
Motive:			

Narrative

- 1 Source:
- 2 On 08-13-19, at approximately 0225 hours, partner Officer [REDACTED] and I were
- 3 working uniformed patrol in the City/County of Riverside. We responded to Box
- 4 Springs Blvd and Eastridge Av, to assist in the investigation.
- 5



Riverside Police Department

Officer Report

File Number:
190023109-022

6 Narrative:

7 Upon arrival, I took a perimeter position on Box Springs Blvd, south of the
8 intersection of Eastridge Av. I ensured no unauthorized persons entered the crime
9 scene. At approximately 0730 hours, I was approached by the manager (O/ [REDACTED])
10 of [REDACTED]. She told me she arrived to work
11 and saw the east wall of the building appeared to have several bullet strikes in it. I
12 advised detectives on scene and they responded to process the scene.

13
14 At approximately 1610 hours, I was relieved from my position by Officer [REDACTED].
15 See additional reports for further information.

16
17 No further information.

18
19

RIVERSIDE POLICE DEPARTMENT



Riverside Police Department

Officer Report

File Number:
190023109-023

Administrative Information

Subject:		1111 - OFFICER NEEDS BACK-UP/URGENT RESPONSE			
Date(s) and Time(s) of Occurrence Or Between:		//			
Location Of Occurrence:		Box Springs Bldg / Eastridge Ave RIVERSIDE			
Date/Time Reported:	8/12/2019 5:38:06 PM	Day:			
Date Of Report:	8/13/2019 4:54:57 PM	Type Of Premises:			
NPC:		RD:	PG08	Beat:	3
Was There a Witness To The Crime?					
Can a Suspect Be Named Or Identified?		By Whom?			
Can a Suspect Vehicle Be Identified?		By Whom?			

Code Section Classification:

Offense	Code Section
MURDER:SECOND DEGREE ON PEACE OFFICER	187(A)
Completed	Yes

Records Section

Reporting Officer:	[REDACTED]		
115 Qualified:	Yes		
Send Copies Of This Report To:			
DOJ/NCIC Entered?		Name/ID	
DOJ/NCIC Cancelled?		Name/ID	
APR Sent?		Name/ID	
APB Sent?		Name/ID	

Public Narrative

On 08-13-19 I was assigned at a scene perimeter while it was processed.

Supervisor Approving

Approving Supervisor:	[REDACTED]
Date Reviewed:	8/20/2019 12:00:00 AM



Riverside Police Department

Officer Report

File Number:
190023109-023

Evidence Information

Physical Evidence Present?		Physical Evidence Seized?	
Photographs Taken?		Photographer?	
Weapon Seized?		Weapon(s) Taken For Safety?	
Gang Related?		Sensitive Data?	
Fingerprint Search Made?		Fingerprints Obtained?	
Narcotics Seized?		Narcotics Field Tested?	
Audio Recording Available?		In Car Recording Available?	
Body Worn Camera Recording Available?			
Type of Weapon, Force, Or Device Used?			
Motive:			

Narrative

1 On Tuesday, August 13th, 2019, Partner Officer [REDACTED] and I (Officer [REDACTED]) were
 2 working uniformed patrol in a marked "City of Riverside" police vehicle. At approximately 0515
 3 hours, at the direction of Lt. [REDACTED], we responded to the intersection of Eastridge Avenue and
 4 Sycamore Canyon Boulevard. We contacted Sgt. [REDACTED] and were assigned to the intersection of
 5 Eastridge Avenue and Valley Springs Parkway for scene preservation. Officer [REDACTED] and I
 6 maintained our position until relieved by K9 Officer [REDACTED]
 7 Nothing Further.
 8



Riverside Police Department

Officer Report

File Number:
190023109-024

Administrative Information

Subject:		1111 - OFFICER NEEDS BACK-UP/URGENT RESPONSE			
Date(s) and Time(s) of Occurrence Or Between:		//			
Location Of Occurrence:		Box Springs Bldg / Eastridge Ave RIVERSIDE			
Date/Time Reported:	8/12/2019 5:38:06 PM	Day:			
Date Of Report:	8/13/2019 5:26:48 PM	Type Of Premises:			
NPC:		RD:	PG08	Beat:	3
Was There a Witness To The Crime?					
Can a Suspect Be Named Or Identified?		By Whom?			
Can a Suspect Vehicle Be Identified?		By Whom?			

Code Section Classification:

Records Section

Reporting Officer:	[REDACTED]				
115 Qualified:	Yes				
Send Copies Of This Report To:					
DOJ/NCIC Entered?		Name/ID			
DOJ/NCIC Cancelled?		Name/ID			
APR Sent?		Name/ID			
APB Sent?		Name/ID			

Public Narrative

Supervisor Approving

Approving Supervisor:	[REDACTED]				
Date Reviewed:	8/20/2019 12:00:00 AM				

Evidence Information

Physical Evidence Present?		Physical Evidence Seized?	
----------------------------	--	---------------------------	--



Riverside Police Department

Officer Report

File Number:
190023109-024

Photographs Taken?		Photographer?	
Weapon Seized?		Weapon(s) Taken For Safety?	
Gang Related?		Sensitive Data?	
Fingerprint Search Made?		Fingerprints Obtained?	
Narcotics Seized?		Narcotics Field Tested?	
Audio Recording Available?		In Car Recording Available?	
Body Worn Camera Recording Available?			
Type of Weapon, Force, Or Device Used?			
Motive:			

Narrative

- 1 On 08/13/19 at approximately 0645 hours, partner Officer [REDACTED] and I were working the
- 2 assignment of Problem Oriented Policing (POP) in a marked black and white police vehicle in the City
- 3 and County of Riverside. We responded to the area of Box Springs Blvd and River Crest Dr. to relieve
- 4 Officers [REDACTED] and [REDACTED]. Upon our arrival we held a perimeter spot at the listed intersection
- 5 and prevented people from driving past Eastridge Ave. Only people that worked on Box Springs Blvd,
- 6 north of Eastridge Ave. were allowed to enter the area. We held a perimeter spot until we were
- 7 relieved by Officer [REDACTED] at approximately 1640 hours.
- 8



Riverside Police Department

Officer Report

File Number:
190023109-025

Administrative Information

Subject:		1111 - OFFICER NEEDS BACK-UP/URGENT RESPONSE			
Date(s) and Time(s) of Occurrence Or Between:		//			
Location Of Occurrence:		Box Springs Bldg / Eastridge Ave RIVERSIDE			
Date/Time Reported:	8/12/2019 5:38:06 PM	Day:			
Date Of Report:	8/13/2019 5:24:56 PM	Type Of Premises:			
NPC:		RD:	PG08	Beat:	3
Was There a Witness To The Crime?					
Can a Suspect Be Named Or Identified?		By Whom?			
Can a Suspect Vehicle Be Identified?		By Whom?			

Code Section Classification:

Records Section

Reporting Officer:	[REDACTED]				
115 Qualified:	Yes				
Send Copies Of This Report To:					
DOJ/NCIC Entered?		Name/ID			
DOJ/NCIC Cancelled?		Name/ID			
APR Sent?		Name/ID			
APB Sent?		Name/ID			

Public Narrative

Supplemental Report

Supervisor Approving

Approving Supervisor:	[REDACTED]				
Date Reviewed:	8/20/2019 12:00:00 AM				

Evidence Information

Physical Evidence Present?		Physical Evidence Seized?	
----------------------------	--	---------------------------	--



Riverside Police Department

Officer Report

File Number:
190023109-025

Photographs Taken?		Photographer?	
Weapon Seized?		Weapon(s) Taken For Safety?	
Gang Related?		Sensitive Data?	
Fingerprint Search Made?		Fingerprints Obtained?	
Narcotics Seized?		Narcotics Field Tested?	
Audio Recording Available?		In Car Recording Available?	
Body Worn Camera Recording Available?			
Type of Weapon, Force, Or Device Used?			
Motive:			

Narrative

- 1 On 08/13/19 at around 0645 hours Partner Officer [REDACTED] and I responded to the area of
- 2 Sycamore Canyon and Eastridge Ave to assist with this call. Upon arrival we contacted Sergeant
- 3 [REDACTED], who directed us to the area of Box Springs and River Crest to assist with traffic control.
- 4 Officer [REDACTED] and I relieved Officers [REDACTED] and blocked the intersection of Box
- 5 Springs and River Crest. Officer [REDACTED] and I continued to block the intersection until around 1640
- 6 hours, when we were relieved by Officer [REDACTED]. At no time did I enter the crime scene, conduct
- 7 interviews or collect evidence.
- 8 NFI
- 9



Riverside Police Department

Officer Report

File Number:
190023109-026

Administrative Information

Subject:	1111 - OFFICER NEEDS BACK-UP/URGENT RESPONSE				
Date(s) and Time(s) of Occurrence Or Between:	//				
Location Of Occurrence:	Box Springs Bldg / Eastridge Ave RIVERSIDE				
Date/Time Reported:	8/12/2019 5:38:06 PM	Day:			
Date Of Report:	8/13/2019 5:32:37 PM	Type Of Premises:			
NPC:		RD:	PG08	Beat:	3
Was There a Witness To The Crime?					
Can a Suspect Be Named Or Identified?		By Whom?			
Can a Suspect Vehicle Be Identified?		By Whom?			

Code Section Classification:

Records Section

Reporting Officer:	[REDACTED]		
115 Qualified:	Yes		
Send Copies Of This Report To:			
DOJ/NCIC Entered?		Name/ID	
DOJ/NCIC Cancelled?		Name/ID	
APR Sent?		Name/ID	
APB Sent?		Name/ID	

Public Narrative

Supervisor Approving

Approving Supervisor:	[REDACTED]
Date Reviewed:	8/13/2019 12:00:00 AM

Evidence Information

Physical Evidence Present?		Physical Evidence Seized?	
----------------------------	--	---------------------------	--



Riverside Police Department

Officer Report

File Number:
190023109-026

Photographs Taken?		Photographer?	
Weapon Seized?		Weapon(s) Taken For Safety?	
Gang Related?		Sensitive Data?	
Fingerprint Search Made?		Fingerprints Obtained?	
Narcotics Seized?		Narcotics Field Tested?	
Audio Recording Available?		In Car Recording Available?	
Body Worn Camera Recording Available?			
Type of Weapon, Force, Or Device Used?			
Motive:			

Narrative

- 1 On 8-12-19, at approximately 2000 hours I responded to the area of Sycamore Canyon Blvd. and
- 2 Eastridge Ave. reference an ongoing officer involved shooting investigation. I was assigned scene
- 3 security at the intersection from 2100 hours until 0530 hours on 8-13-19. At approximately 0530
- 4 hours I was relieved from my assignment by assisting officers and sent home. NFI.
- 5



Riverside Police Department

Officer Report

File Number:
190023109-027

Administrative Information

Subject:	1111 - OFFICER NEEDS BACK-UP/URGENT RESPONSE				
Date(s) and Time(s) of Occurrence Or Between:	//				
Location Of Occurrence:	Box Springs Bldg / Eastridge Ave RIVERSIDE				
Date/Time Reported:	8/12/2019 5:38:06 PM	Day:			
Date Of Report:	8/13/2019 5:38:39 PM	Type Of Premises:			
NPC:		RD:	PG08	Beat:	3
Was There a Witness To The Crime?					
Can a Suspect Be Named Or Identified?		By Whom?			
Can a Suspect Vehicle Be Identified?		By Whom?			

Code Section Classification:

Records Section

Reporting Officer:	[REDACTED]		
115 Qualified:	No		
Send Copies Of This Report To:			
DOJ/NCIC Entered?		Name/ID	
DOJ/NCIC Cancelled?		Name/ID	
APR Sent?		Name/ID	
APB Sent?		Name/ID	

Public Narrative

Supervisor Approving

Approving Supervisor:	[REDACTED]
Date Reviewed:	8/13/2019 12:00:00 AM

Evidence Information

Physical Evidence Present?		Physical Evidence Seized?	
----------------------------	--	---------------------------	--



Riverside Police Department

Officer Report

File Number:
190023109-027

Photographs Taken?		Photographer?	
Weapon Seized?		Weapon(s) Taken For Safety?	
Gang Related?		Sensitive Data?	
Fingerprint Search Made?		Fingerprints Obtained?	
Narcotics Seized?		Narcotics Field Tested?	
Audio Recording Available?		In Car Recording Available?	
Body Worn Camera Recording Available?			
Type of Weapon, Force, Or Device Used?			
Motive:			

Narrative

- 1 On 08-12-19, at approximately 1951 hours, I responded to RUHSMC (26520 Cactus Ave Moreno Valley
- 2 CA) reference an officer involved shooting. I was assigned to stand by with the Riverside PD Air 1
- 3 helicopter while it was being processed by crime scene technicians. I stayed with the helicopter until
- 4 2230 hours, when it was flown from the hospital back to the Riverside PD hangar. At that time I
- 5 responded to the area Sycamore Canyon and Eastridge Ave and provided traffic control. I blocked traffic
- 6 on Eastridge Ave just West of the 215N off-ramp until 0530 hours when I was relieved by Officer
- 7 [REDACTED]
- 8
- 9



Riverside Police Department

Officer Report

File Number:
190023109-028

Administrative Information

Subject:	1111 - OFFICER NEEDS BACK-UP/URGENT RESPONSE				
Date(s) and Time(s) of Occurrence Or Between:	//				
Location Of Occurrence:	Box Springs Bldg / Eastridge Ave RIVERSIDE				
Date/Time Reported:	8/12/2019 5:38:06 PM	Day:			
Date Of Report:	8/13/2019 5:32:30 PM	Type Of Premises:			
NPC:		RD:	PG08	Beat:	3
Was There a Witness To The Crime?					
Can a Suspect Be Named Or Identified?		By Whom?			
Can a Suspect Vehicle Be Identified?		By Whom?			

Code Section Classification:

Records Section

Reporting Officer:	[REDACTED]		
115 Qualified:	Yes		
Send Copies Of This Report To:			
DOJ/NCIC Entered?		Name/ID	
DOJ/NCIC Cancelled?		Name/ID	
APR Sent?		Name/ID	
APB Sent?		Name/ID	

Public Narrative

Supervisor Approving

Approving Supervisor:	[REDACTED]
Date Reviewed:	8/13/2019 12:00:00 AM

Evidence Information

Physical Evidence Present?		Physical Evidence Seized?	
----------------------------	--	---------------------------	--



Riverside Police Department

Officer Report

File Number:
190023109-028

Photographs Taken?		Photographer?	
Weapon Seized?		Weapon(s) Taken For Safety?	
Gang Related?		Sensitive Data?	
Fingerprint Search Made?		Fingerprints Obtained?	
Narcotics Seized?		Narcotics Field Tested?	
Audio Recording Available?		In Car Recording Available?	
Body Worn Camera Recording Available?			
Type of Weapon, Force, Or Device Used?			
Motive:			

Narrative

- 1 On 08/12/19, I was assigned to the Riverside Police Dept. METRO team. At approximately 1800
- 2 hours, I was alerted to an OIS within the city limits involving several agencies including CHP, RSO and
- 3 RPD. At approximately 2000 hours, the METRO team was requested to assist with scene security for
- 4 the incident, I responded to the command post where I met with Officer [REDACTED], Officer [REDACTED] and I
- 5 then took a perimeter position at the intersection of Eucalyptus Ave and Old 215. We maintained this
- 6 position until relieved by Officer [REDACTED] at approximately 0530 hours.
- 7



Riverside Police Department

Officer Report

File Number:
190023109-029

Administrative Information

Subject:	1111 - OFFICER NEEDS BACK-UP/URGENT RESPONSE				
Date(s) and Time(s) of Occurrence Or Between:	//				
Location Of Occurrence:	Box Springs Bldg / Eastridge Ave RIVERSIDE				
Date/Time Reported:	8/12/2019 5:38:06 PM	Day:			
Date Of Report:	8/13/2019 5:35:46 PM	Type Of Premises:			
NPC:		RD:	PG08	Beat:	3
Was There a Witness To The Crime?					
Can a Suspect Be Named Or Identified?			By Whom?		
Can a Suspect Vehicle Be Identified?			By Whom?		

Code Section Classification:

Records Section

Reporting Officer:	[REDACTED]		
115 Qualified:	Yes		
Send Copies Of This Report To:			
DOJ/NCIC Entered?		Name/ID	
DOJ/NCIC Cancelled?		Name/ID	
APR Sent?		Name/ID	
APB Sent?		Name/ID	

Public Narrative

Supervisor Approving

Approving Supervisor:	[REDACTED]
Date Reviewed:	8/13/2019 12:00:00 AM

Evidence Information

Physical Evidence Present?		Physical Evidence Seized?	
----------------------------	--	---------------------------	--



Riverside Police Department

Officer Report

File Number:
190023109-029

Photographs Taken?		Photographer?	
Weapon Seized?		Weapon(s) Taken For Safety?	
Gang Related?		Sensitive Data?	
Fingerprint Search Made?		Fingerprints Obtained?	
Narcotics Seized?		Narcotics Field Tested?	
Audio Recording Available?		In Car Recording Available?	
Body Worn Camera Recording Available?			
Type of Weapon, Force, Or Device Used?			
Motive:			

Narrative

- 1 Narrative:
- 2 On 08-12-19 at about 2000 hours, I was assigned to the METRO Team and responded to the area of
- 3 Box Springs/Eastridge, in the City and County of Riverside to assist with an Officer Involved Shooting.
- 4 From about 2100 hours to 08-13-19 at 0515 hours, I took up a post with other members of the
- 5 METRO Team at Eastridge/Sycamore Canyon. We provided security for the crime scene until 0515
- 6 hours, when we were relieved by other RPD personnel.
- 7



Riverside Police Department

Officer Report

File Number:
190023109-030

Administrative Information

Subject: 1111 - OFFICER NEEDS BACK-UP/URGENT RESPONSE				
Date(s) and Time(s) of Occurrence Or Between:		8/12/2019 5:15:00 PM //		
Location Of Occurrence:		Box Springs Bldg / Eastridge Ave RIVERSIDE		
Date/Time Reported:	8/12/2019 5:38:06 PM	Day:	Monday	
Date Of Report:	8/13/2019 5:34:22 PM	Type Of Premises:		
NPC:		RD:	PG08	Beat: 3
Was There a Witness To The Crime?				
Can a Suspect Be Named Or Identified?		By Whom?		
Can a Suspect Vehicle Be Identified?		By Whom?		

Code Section Classification:

Records Section

Reporting Officer:	[REDACTED]		
115 Qualified:	Yes		
Send Copies Of This Report To:			
DOJ/NCIC Entered?		Name/ID	
DOJ/NCIC Cancelled?		Name/ID	
APR Sent?		Name/ID	
APB Sent?		Name/ID	

Public Narrative

Supervisor Approving

Approving Supervisor:	[REDACTED]
Date Reviewed:	8/13/2019 12:00:00 AM

Evidence Information

Physical Evidence Present?		Physical Evidence Seized?	
----------------------------	--	---------------------------	--



Riverside Police Department

Officer Report

File Number:
190023109-030

Photographs Taken?		Photographer?	
Weapon Seized?		Weapon(s) Taken For Safety?	
Gang Related?		Sensitive Data?	
Fingerprint Search Made?		Fingerprints Obtained?	
Narcotics Seized?		Narcotics Field Tested?	
Audio Recording Available?		In Car Recording Available?	
Body Worn Camera Recording Available?			
Type of Weapon, Force, Or Device Used?			
Motive:			

Narrative

- 1 On 08/12/2019, 2000 hours, I was called from home as part of the full time SWAT team to assist
- 2 with scene security at an Officer involved shooting that had occurred at Eucalyptus and the 215FWY.
- 3 When I arrived I was assigned with Officer [REDACTED] to take a perimeter position at the Old 215
- 4 Frontage Rd. and Eucalyptus to block traffic and maintain scene security. We were assigned there
- 5 until 0530 hours the following day when we were relieved by other police officers.
- 6



Riverside Police Department

Officer Report

File Number:
190023109-031

Administrative Information

Subject:	1111 - OFFICER NEEDS BACK-UP/URGENT RESPONSE				
Date(s) and Time(s) of Occurrence Or Between:	//				
Location Of Occurrence:	Box Springs Bldg / Eastridge Ave RIVERSIDE				
Date/Time Reported:	8/12/2019 5:38:06 PM	Day:			
Date Of Report:	8/13/2019 5:41:54 PM	Type Of Premises:			
NPC:		RD:	PG08	Beat:	3
Was There a Witness To The Crime?					
Can a Suspect Be Named Or Identified?			By Whom?		
Can a Suspect Vehicle Be Identified?			By Whom?		

Code Section Classification:

Records Section

Reporting Officer:	[REDACTED]		
115 Qualified:	Yes		
Send Copies Of This Report To:			
DOJ/NCIC Entered?		Name/ID	
DOJ/NCIC Cancelled?		Name/ID	
APR Sent?		Name/ID	
APB Sent?		Name/ID	

Public Narrative

Supervisor Approving

Approving Supervisor:	[REDACTED]
Date Reviewed:	8/13/2019 12:00:00 AM

Evidence Information

Physical Evidence Present?		Physical Evidence Seized?	
----------------------------	--	---------------------------	--



Riverside Police Department

Officer Report

File Number:
190023109-031

Photographs Taken?		Photographer?	
Weapon Seized?		Weapon(s) Taken For Safety?	
Gang Related?		Sensitive Data?	
Fingerprint Search Made?		Fingerprints Obtained?	
Narcotics Seized?		Narcotics Field Tested?	
Audio Recording Available?		In Car Recording Available?	
Body Worn Camera Recording Available?			
Type of Weapon, Force, Or Device Used?			
Motive:			

Narrative

- 1 On 08-12-19, at approximately 2000 hours, I learned of an OIS which occurred in the area of
- 2 Sycamore Canyon and Eastridge in the City of Riverside. I responded, along with several officers from
- 3 the RPD METRO Team, to the area of Sycamore Canyon on Eastridge to take a position with the ARV
- 4 (Armored Rescue Vehicle). I directed traffic and provided scene security until 08-13-19 at
- 5 approximately 0530 hours.
- 6



Riverside Police Department

Officer Report

File Number:
190023109-032

Administrative Information

Subject:		1111 - OFFICER NEEDS BACK-UP/URGENT RESPONSE			
Date(s) and Time(s) of Occurrence Or Between:		//			
Location Of Occurrence:		Box Springs Bldg / Eastridge Ave RIVERSIDE			
Date/Time Reported:	8/12/2019 5:38:06 PM	Day:			
Date Of Report:	8/13/2019 5:38:22 PM	Type Of Premises:			
NPC:		RD:	PG08	Beat:	3
Was There a Witness To The Crime?					
Can a Suspect Be Named Or Identified?		By Whom?			
Can a Suspect Vehicle Be Identified?		By Whom?			

Code Section Classification:

Records Section

Reporting Officer:	[REDACTED]				
115 Qualified:	Yes				
Send Copies Of This Report To:					
DOJ/NCIC Entered?		Name/ID			
DOJ/NCIC Cancelled?		Name/ID			
APR Sent?		Name/ID			
APB Sent?		Name/ID			

Public Narrative

Supervisor Approving

Approving Supervisor:	[REDACTED]				
Date Reviewed:	8/13/2019 12:00:00 AM				

Evidence Information

Physical Evidence Present?		Physical Evidence Seized?	
----------------------------	--	---------------------------	--



Riverside Police Department

Officer Report

File Number:
190023109-032

Photographs Taken?		Photographer?	
Weapon Seized?		Weapon(s) Taken For Safety?	
Gang Related?		Sensitive Data?	
Fingerprint Search Made?		Fingerprints Obtained?	
Narcotics Seized?		Narcotics Field Tested?	
Audio Recording Available?		In Car Recording Available?	
Body Worn Camera Recording Available?			
Type of Weapon, Force, Or Device Used?			
Motive:			

Narrative

- 1 On 08-12-19, at approximately 1951 hours, I responded to RUHSMC (26520 Cactus Ave Moreno
- 2 Valley CA) reference an officer involved shooting. I was assigned to stand by with the Riverside PD
- 3 Air 1 helicopter while it was being processed by crime scene technicians. I stayed with the helicopter
- 4 until 2230 hours, when it was flown from the hospital back to the Riverside PD hangar. At that time I
- 5 responded to the area Sycamore Canyon and Eastridge Ave and provided traffic control. I blocked
- 6 traffic on Eastridge Ave just West of the 215N off-ramp until 0530 hours when I was relieved by
- 7 Officer [REDACTED]
- 8



Riverside Police Department

Officer Report

File Number:
190023109-033

Administrative Information

Subject:		1111 - OFFICER NEEDS BACK-UP/URGENT RESPONSE			
Date(s) and Time(s) of Occurrence Or Between:		//			
Location Of Occurrence:		Box Springs Bldg / Eastridge Ave RIVERSIDE			
Date/Time Reported:	8/12/2019 5:38:06 PM	Day:			
Date Of Report:	8/13/2019 5:53:02 PM	Type Of Premises:			
NPC:		RD:	PG08	Beat:	3
Was There a Witness To The Crime?					
Can a Suspect Be Named Or Identified?		By Whom?			
Can a Suspect Vehicle Be Identified?		By Whom?			

Code Section Classification:

Records Section

Reporting Officer:	[REDACTED]				
115 Qualified:	Yes				
Send Copies Of This Report To:					
DOJ/NCIC Entered?		Name/ID			
DOJ/NCIC Cancelled?		Name/ID			
APR Sent?		Name/ID			
APB Sent?		Name/ID			

Public Narrative

OIS

Supervisor Approving

Approving Supervisor:	[REDACTED]				
Date Reviewed:	8/13/2019 12:00:00 AM				

Evidence Information

Physical Evidence Present?		Physical Evidence Seized?	
----------------------------	--	---------------------------	--



Riverside Police Department

Officer Report

File Number:
190023109-033

Photographs Taken?		Photographer?	
Weapon Seized?		Weapon(s) Taken For Safety?	
Gang Related?		Sensitive Data?	
Fingerprint Search Made?		Fingerprints Obtained?	
Narcotics Seized?		Narcotics Field Tested?	
Audio Recording Available?		In Car Recording Available?	
Body Worn Camera Recording Available?			
Type of Weapon, Force, Or Device Used?			
Motive:			

Narrative

- 1 On 08-12-19 at about 2000 hours, I was assigned to the METRO Team and responded to the area of
- 2 Box Springs/Eastridge, in the City and County of Riverside to assist with an Officer Involved Shooting.
- 3 From about 2100 hours to 08-13-19 at 0515 hours, I took up a post with other members of the
- 4 METRO Team at Eastridge/Sycamore Canyon. We provided security for the crime scene until 0515
- 5 hours, when we were relieved by other RPD personnel.
- 6



Riverside Police Department

Officer Report

File Number:
190023109-034

Administrative Information

Subject:	1111 - OFFICER NEEDS BACK-UP/URGENT RESPONSE				
Date(s) and Time(s) of Occurrence Or Between:	8/12/2019 5:38:00 PM //				
Location Of Occurrence:	Box Springs Bldg / Eastridge Ave RIVERSIDE				
Date/Time Reported:	8/12/2019 5:38:06 PM	Day:	Monday		
Date Of Report:	8/13/2019 5:54:32 PM	Type Of Premises:			
NPC:		RD:	PG08	Beat:	3
Was There a Witness To The Crime?					
Can a Suspect Be Named Or Identified?		By Whom?			
Can a Suspect Vehicle Be Identified?		By Whom?			

Code Section Classification:

Records Section

Reporting Officer:	[REDACTED]		
115 Qualified:	Yes		
Send Copies Of This Report To:			
DOJ/NCIC Entered?		Name/ID	
DOJ/NCIC Cancelled?		Name/ID	
APR Sent?		Name/ID	
APB Sent?		Name/ID	

Public Narrative

See initial report for details.

Supervisor Approving

Approving Supervisor:	[REDACTED]
Date Reviewed:	8/15/2019 12:00:00 AM

Evidence Information

Physical Evidence Present?		Physical Evidence Seized?	
----------------------------	--	---------------------------	--



Riverside Police Department

Officer Report

File Number:
190023109-034

Photographs Taken?		Photographer?	
Weapon Seized?		Weapon(s) Taken For Safety?	
Gang Related?		Sensitive Data?	
Fingerprint Search Made?		Fingerprints Obtained?	
Narcotics Seized?		Narcotics Field Tested?	
Audio Recording Available?		In Car Recording Available?	
Body Worn Camera Recording Available?			
Type of Weapon, Force, Or Device Used?			
Motive:			

Narrative

1 **Source:**

2 On August 13th, 2019, partner Officer [REDACTED] and I (Officer [REDACTED]) were working uniformed
3 patrol in a marked police vehicle in the city and county of Riverside. At approximately 0515
4 hours, we responded to the intersection of Eastridge Avenue and Sycamore Canyon Boulevard at
5 the direction of Lt. [REDACTED]

6
7 **Narrative:**

8 Upon our arrival, we contacted Sgt. [REDACTED] and were assigned to the intersection of Eastridge
9 Avenue and Sycamore Canyon Boulevard for scene security. Officer [REDACTED] and I maintained
10 our position until relieved at approximately 1840 hours, by Officer's [REDACTED]

11
12 Nothing Further. .

13
14
15



Riverside Police Department

Officer Report

File Number:
190023109-035

Administrative Information

Subject:		1111 - OFFICER NEEDS BACK-UP/URGENT RESPONSE			
Date(s) and Time(s) of Occurrence Or Between:		//			
Location Of Occurrence:		Box Springs Bldg / Eastridge Ave RIVERSIDE			
Date/Time Reported:	8/12/2019 5:38:06 PM	Day:			
Date Of Report:	8/13/2019 5:16:12 PM	Type Of Premises:			
NPC:		RD:	PG08	Beat:	3
Was There a Witness To The Crime?					
Can a Suspect Be Named Or Identified?		By Whom?			
Can a Suspect Vehicle Be Identified?		By Whom?			

Code Section Classification:

Records Section

Reporting Officer:	[REDACTED]				
115 Qualified:	Yes				
Send Copies Of This Report To:					
DOJ/NCIC Entered?		Name/ID			
DOJ/NCIC Cancelled?		Name/ID			
APR Sent?		Name/ID			
APB Sent?		Name/ID			

Public Narrative

Supervisor Approving

Approving Supervisor:	[REDACTED]				
Date Reviewed:	8/20/2019 12:00:00 AM				

Evidence Information

Physical Evidence Present?		Physical Evidence Seized?	
----------------------------	--	---------------------------	--



Riverside Police Department

Officer Report

File Number:
190023109-035

Photographs Taken?		Photographer?	
Weapon Seized?		Weapon(s) Taken For Safety?	
Gang Related?		Sensitive Data?	
Fingerprint Search Made?		Fingerprints Obtained?	
Narcotics Seized?		Narcotics Field Tested?	
Audio Recording Available?		In Car Recording Available?	
Body Worn Camera Recording Available?			
Type of Weapon, Force, Or Device Used?			
Motive:			

Narrative

- 1 **Supplemental Report:**
- 2 On 08-13-19, I Officer [REDACTED] was working as a POP (Problem Oriented Policing) officer for the City
- 3 of Riverside Police Department. I was wearing a readily identifiable police uniform and I was driving
- 4 in a black and white marked patrol car (Unit #3757). The following incident occurred in the City of
- 5 Riverside and in the County of Riverside.
- 6
- 7 At approximately 1000 hours, I arrived to assist officers with the investigation at Eastridge Avenue
- 8 and Box Springs Blvd. On scene I contacted Sergeant [REDACTED] who shortly after advised me that I was
- 9 no longer needed. I cleared the scene and I showed myself in service.
- 10
- 11 At approximately 1400 hours, I was directed by the Watch Commander [REDACTED], to respond back
- 12 to the above location and relieve Officer [REDACTED] and Officer [REDACTED], who were providing scene
- 13 security at the intersection of Eastridge Avenue and Sycamore Canyon Blvd. On scene I contacted
- 14 Sergeant [REDACTED]
- 15



Riverside Police Department

Officer Report

File Number:
190023109-036

Administrative Information

Subject:	1111 - OFFICER NEEDS BACK-UP/URGENT RESPONSE				
Date(s) and Time(s) of Occurrence Or Between:	//				
Location Of Occurrence:	Box Springs Bldg / Eastridge Ave RIVERSIDE				
Date/Time Reported:	8/12/2019 5:38:06 PM	Day:			
Date Of Report:	8/13/2019 8:05:19 PM	Type Of Premises:			
NPC:		RD:	PG08	Beat:	3
Was There a Witness To The Crime?					
Can a Suspect Be Named Or Identified?		By Whom?			
Can a Suspect Vehicle Be Identified?		By Whom?			

Code Section Classification:

Records Section

Reporting Officer:	[REDACTED]		
115 Qualified:	Yes		
Send Copies Of This Report To:			
DOJ/NCIC Entered?		Name/ID	
DOJ/NCIC Cancelled?		Name/ID	
APR Sent?		Name/ID	
APB Sent?		Name/ID	

Public Narrative

I responded to an officer needing assistance call.

Supervisor Approving

Approving Supervisor:	[REDACTED]
Date Reviewed:	8/15/2019 12:00:00 AM

Evidence Information

Physical Evidence Present?		Physical Evidence Seized?	
----------------------------	--	---------------------------	--



Riverside Police Department

Officer Report

File Number:
190023109-036

Photographs Taken?		Photographer?	
Weapon Seized?		Weapon(s) Taken For Safety?	
Gang Related?		Sensitive Data?	
Fingerprint Search Made?		Fingerprints Obtained?	
Narcotics Seized?		Narcotics Field Tested?	
Audio Recording Available?		In Car Recording Available?	
Body Worn Camera Recording Available?			
Type of Weapon, Force, Or Device Used?			
Motive:			

Narrative

- 1 I responded to a radio call requesting assistance for an officer down with shots fired. I responded
- 2 from the Lincoln Station. Upon arrival I contacted Officer K. Feimer #1001 and determined he had
- 3 discharged his service firearm. I asked Officer Feimer the standard safety questions and stood by with
- 4 him until his transportation to the Magnolia Police station was arranged. I then assisted with setting
- 5 up scene security on the western edge of the crime scene. I assisted with arranging for MAIT
- 6 personnel to respond to the scene to assist with the scene documentation. I remained as a
- 7 supervisor on the western edge for scene security until relieved at 2300 hours.
- 8



Riverside Police Department

Officer Report

File Number:
190023109-037

Administrative Information

Subject:	PC 187 -Murder				
Date(s) and Time(s) of Occurrence Or Between:	//				
Location Of Occurrence:	Box Springs Bldg / Eastridge Ave RIVERSIDE				
Date/Time Reported:	8/12/2019 5:38:06 PM	Day:			
Date Of Report:	8/13/2019 8:24:34 PM	Type Of Premises:			
NPC:		RD:	PG08	Beat:	3
Was There a Witness To The Crime?					
Can a Suspect Be Named Or Identified?		By Whom?			
Can a Suspect Vehicle Be Identified?		By Whom?			

Code Section Classification:

Records Section

Reporting Officer:	[REDACTED]		
115 Qualified:	Yes		
Send Copies Of This Report To:			
DOJ/NCIC Entered?		Name/ID	
DOJ/NCIC Cancelled?		Name/ID	
APR Sent?		Name/ID	
APB Sent?		Name/ID	

Public Narrative

Supplemental report.

Supervisor Approving

Approving Supervisor:	[REDACTED]
Date Reviewed:	8/20/2019 12:00:00 AM

Witness Information

Code:		Name:	[REDACTED]
[REDACTED]	[REDACTED]	[REDACTED]	[REDACTED]



Riverside Police Department

Officer Report

File Number:
190023109-037

[REDACTED]	[REDACTED]	[REDACTED]	[REDACTED]
[REDACTED]	[REDACTED]	[REDACTED]	[REDACTED]
Notes:			

Witness Addresses:

[REDACTED]	[REDACTED]	[REDACTED]	[REDACTED]
[REDACTED]	[REDACTED]	[REDACTED]	[REDACTED]

Witness Phones:

[REDACTED]	[REDACTED]
[REDACTED]	[REDACTED]

Evidence Information			
Physical Evidence Present?		Physical Evidence Seized?	
Photographs Taken?		Photographer?	
Weapon Seized?		Weapon(s) Taken For Safety?	
Gang Related?		Sensitive Data?	
Fingerprint Search Made?		Fingerprints Obtained?	
Narcotics Seized?		Narcotics Field Tested?	
Audio Recording Available?		In Car Recording Available?	
Body Worn Camera Recording Available?			
Type of Weapon, Force, Or Device Used?			
Motive:			

Narrative

- 1 **Assignment:**
- 2
- 3 On Monday, August 12th, 2019, at approximately 1740 hours, I was working uniformed patrol as
- 4 a police officer for the City of Riverside assigned as 3R24 (East). At the above date and time, I
- 5 conducted a traffic stop at the intersection of Kansas Ave. and Linden St. in the City of
- 6 Riverside.
- 7
- 8 While conducting a probation search of the vehicle, a radio transmission over the main channel
- 9 (1) went out informing all working units that a California Highway police officer was requesting



Riverside Police Department

Officer Report

File Number:
190023109-037

10 an "11-11" or emergency back-up in the area of Eastridge Ave. and Box Springs Rd. in the City
11 of Riverside.

12
13 Based on the information broadcasted over the radio, gun shots had been fired and the suspect
14 was actively shooting at the officers. I immediately terminated my traffic stop, entered my police
15 vehicle and drove to the listed area with activated lights and sirens.

16
17 *The following is a summary of this call for service. All statements were recorded with my*
18 *department issued "BVS."*

19 20 Initial Observations:

21
22 Upon arrival, I stopped my police vehicle on the southbound off ramp of the 215 freeway at
23 Eastridge Ave. There were multiple vehicles stopped on the ramp including civilian and police. I
24 also noticed several fellow officers running up the ramp towards the bridge where I assumed the
25 suspect was located. Traffic was heavy in all directions at the time of my arrival.

26 27 Actions:

28
29 I ran up the off ramp with my patrol rifle following fellow officers to where the suspect was
30 located. As I reached the bridge, I observed several officers from various agencies approaching
31 the suspect who was lying on his back to the front of a white pick-up truck. I approached the
32 arrest team who was rendering medical aid to the suspect. I then took crime scene tape and
33 assisted other officers in securing the scene from a pole located on the north curb of Eastridge
34 Ave. I also located the tow truck driver who was at the scene at the time of the shooting.

35 36 Statements of W [REDACTED]

37
38 W [REDACTED] stated he was dispatched to the listed location to impound a vehicle. When he arrived,
39 the CHP officer had all the paperwork ready to impound the vehicle. He also noticed that the
40 driver of the vehicle, S1, was pulling items out of his truck from the front passenger side.

41 W [REDACTED] stated that both officers were near their police vehicles parked directly behind S1. The
42 officers were not supervising S1 as he was retrieving items from inside his truck.

43
44 W [REDACTED] then approached the suspect vehicle to get the mileage on it for the CHP 180 report.
45 When he looked inside the vehicle, he noticed what appeared to be a rifle on the floorboard of
46 the passenger side of the vehicle. The rifle was leaning against the passenger seat and the
47 suspected rifle was covered with a shirt and an unknown color reflective vest.

48
49 W [REDACTED] walked towards the officers who were standing next to a police vehicle directly
50 behind the suspect vehicle. W [REDACTED] then attempted to tell the officers that there was possibly a
51 rifle inside the vehicle. While speaking to the officers, S1 began firing at the officers at which
52 point W [REDACTED] ran away from the scene eastbound on the bridge. He further stated his partner



Riverside Police Department

Officer Report

File Number:
190023109-037

53 who was inside the tow truck, drove westbound on the bridge and he lost sight of him. W/ [REDACTED]
54 did not sustain any injuries as a result of the shooting.

55

56 **Actions:**

57

58 After obtaining W/ [REDACTED] statement, I was instructed by Sergeant [REDACTED] to stand near the
59 vehicles involved in the shooting and provide scene containment. I was relieved from my duties
60 at approximately 0345 hours the following morning by Riverside Police Department Detectives.

61

62 NFI

63

RIVERSIDE POLICE DEPARTMENT



Riverside Police Department

Officer Report

File Number:
190023109-038

Administrative Information

Subject:	1111 - OFFICER NEEDS BACK-UP/URGENT RESPONSE		
Date(s) and Time(s) of Occurrence Or Between:	//		
Location Of Occurrence:			
Date/Time Reported:		Day:	
Date Of Report:	8/13/2019 6:10:06 PM	Type Of Premises:	
NPC:		RD:	
		Beat:	
Was There a Witness To The Crime?			
Can a Suspect Be Named Or Identified?		By Whom?	
Can a Suspect Vehicle Be Identified?		By Whom?	

Code Section Classification:

Records Section

Reporting Officer:	[REDACTED]		
115 Qualified:	Yes		
Send Copies Of This Report To:			
DOJ/NCIC Entered?		Name/ID	
DOJ/NCIC Cancelled?		Name/ID	
APR Sent?		Name/ID	
APB Sent?		Name/ID	

Public Narrative

Supervisor Approving

Approving Supervisor:	[REDACTED]		
Date Reviewed:	8/17/2019 12:00:00 AM		

Evidence Information

Physical Evidence Present?		Physical Evidence Seized?	
----------------------------	--	---------------------------	--



Riverside Police Department

Officer Report

File Number:
190023109-038

Photographs Taken?		Photographer?	
Weapon Seized?		Weapon(s) Taken For Safety?	
Gang Related?		Sensitive Data?	
Fingerprint Search Made?		Fingerprints Obtained?	
Narcotics Seized?		Narcotics Field Tested?	
Audio Recording Available?		In Car Recording Available?	
Body Worn Camera Recording Available?			
Type of Weapon, Force, Or Device Used?			
Motive:			

Narrative

- 1 On 08/13/19 at about 1600 hours, I responded to the intersection of Eastridge Ave. and the 215
- 2 freeway, on and off ramps, at the direction of on scene supervision.
- 3
- 4 At 2125 hours, Riverside City Fire department personal [REDACTED] arrived on scene and
- 5 entered into the crime scene to remove Battalion #1 unit from the scene. The unit left the crime
- 6 scene at 2129 hours.
- 7
- 8 At 2125 hours, Riverside City Fire department personal [REDACTED] arrived on scene and
- 9 entered into the crime scene to remove Engine #4 unit from the scene. The unit left the crime scene
- 10 at 2130 hours.
- 11
- 12 I remained on the outside perimeter of the crime scene until released by supervision at 0230 hours.
- 13 No further information.
- 14



Riverside Police Department

Officer Report

File Number:
190023109-039

Administrative Information

Subject:	1111 - OFFICER NEEDS BACK-UP/URGENT RESPONSE				
Date(s) and Time(s) of Occurrence Or Between:	//				
Location Of Occurrence:	Box Springs Bldg / Eastridge Ave RIVERSIDE				
Date/Time Reported:	8/12/2019 5:38:06 PM	Day:			
Date Of Report:	8/14/2019 2:56:36 AM	Type Of Premises:			
NPC:		RD:	PG08	Beat:	3
Was There a Witness To The Crime?					
Can a Suspect Be Named Or Identified?		By Whom?			
Can a Suspect Vehicle Be Identified?		By Whom?			

Code Section Classification:

Records Section

Reporting Officer:	[REDACTED] id		
115 Qualified:	Yes		
Send Copies Of This Report To:			
DOJ/NCIC Entered?		Name/ID	
DOJ/NCIC Cancelled?		Name/ID	
APR Sent?		Name/ID	
APB Sent?		Name/ID	

Public Narrative

supplemental report to OIS scene preservation.

Supervisor Approving

Approving Supervisor:	[REDACTED]
Date Reviewed:	8/14/2019 12:00:00 AM

Evidence Information

Physical Evidence Present?		Physical Evidence Seized?	
----------------------------	--	---------------------------	--



Riverside Police Department

Officer Report

File Number:
190023109-039

Photographs Taken?		Photographer?	
Weapon Seized?		Weapon(s) Taken For Safety?	
Gang Related?		Sensitive Data?	
Fingerprint Search Made?		Fingerprints Obtained?	
Narcotics Seized?		Narcotics Field Tested?	
Audio Recording Available?		In Car Recording Available?	
Body Worn Camera Recording Available?			
Type of Weapon, Force, Or Device Used?			
Motive:			

Narrative

1 Details:

2
3 On Tuesday, August 13, 2019, I was working as a uniformed Riverside Police Officer and was
4 driving a marked police vehicle. At approximately 6:00 PM, at the direction of Sergeant [REDACTED]
5 I responded to the intersection of Eastridge Avenue and Old 215 Road for scene preservation.

6
7 At 10:05 PM the drivers of two vehicles inside the scene arrived to pick up their vehicles.
8 O1 [REDACTED] the driver of a 2013 Toyota Venza, Ca license plate [REDACTED], and
9 O2 [REDACTED], the driver of a 2015 Ford C-Max, Ca license plate [REDACTED], took
10 custody of their vehicles. Both parties cleared the scene along with their vehicles at 10:30 PM.

11
12 I maintained this position until I was relieved by Officer [REDACTED] on Wednesday, August 14,
13 2019, at 4:25 AM.

14
15 Nothing Further.

16



Riverside Police Department

Officer Report

File Number:
190023109-040

Administrative Information

Subject:	1111 - OFFICER NEEDS BACK-UP/URGENT RESPONSE				
Date(s) and Time(s) of Occurrence Or Between:	//				
Location Of Occurrence:	Box Springs Bldg / Eastridge Ave RIVERSIDE				
Date/Time Reported:	8/12/2019 5:38:06 PM	Day:			
Date Of Report:	8/14/2019 8:21:18 AM	Type Of Premises:			
NPC:		RD:	PG08	Beat:	3
Was There a Witness To The Crime?					
Can a Suspect Be Named Or Identified?		By Whom?			
Can a Suspect Vehicle Be Identified?		By Whom?			

Code Section Classification:

Records Section

Reporting Officer:	[REDACTED]				
115 Qualified:	Yes				
Send Copies Of This Report To:					
DOJ/NCIC Entered?		Name/ID			
DOJ/NCIC Cancelled?		Name/ID			
APR Sent?		Name/ID			
APB Sent?		Name/ID			

Public Narrative

Supervisor Approving

Approving Supervisor:	[REDACTED]				
Date Reviewed:	8/17/2019 12:00:00 AM				

Evidence Information

Physical Evidence Present?		Physical Evidence Seized?	
----------------------------	--	---------------------------	--



Riverside Police Department

Officer Report

File Number:
190023109-040

Photographs Taken?		Photographer?	
Weapon Seized?		Weapon(s) Taken For Safety?	
Gang Related?		Sensitive Data?	
Fingerprint Search Made?		Fingerprints Obtained?	
Narcotics Seized?		Narcotics Field Tested?	
Audio Recording Available?		In Car Recording Available?	
Body Worn Camera Recording Available?			
Type of Weapon, Force, Or Device Used?			
Motive:			

Narrative

1 **Investigative Actions:**

- 2 On 08-13-19, Lt. [REDACTED] requested additional Officers/Detectives to relieve officers on the
3 perimeter of the above incident. Upon arrival, I stood post at Eastridge Ave and Sycamore Canyon
4 Blvd with Officer [REDACTED] from 1700 hours till about 2230 hours. At about 2230 hours I parked my
5 assigned black and white patrol unit at Eastridge Ave and Old 215 Frontage Rd. The unit remained
6 at the intersection unoccupied until other officer returned the police unit to the station.
7 No further actions taken.
8



Riverside Police Department

Officer Report

File Number:
190023109-041

Administrative Information

Subject:	1111 - OFFICER NEEDS BACK-UP/URGENT RESPONSE				
Date(s) and Time(s) of Occurrence Or Between:	//				
Location Of Occurrence:	Box Springs Bldg / Eastridge Ave RIVERSIDE				
Date/Time Reported:	8/12/2019 5:38:06 PM	Day:			
Date Of Report:	8/14/2019 8:28:12 AM	Type Of Premises:			
NPC:		RD:	PG08	Beat:	3
Was There a Witness To The Crime?					
Can a Suspect Be Named Or Identified?		By Whom?			
Can a Suspect Vehicle Be Identified?		By Whom?			

Code Section Classification:

Records Section

Reporting Officer:	[REDACTED]		
115 Qualified:	Yes		
Send Copies Of This Report To:			
DOJ/NCIC Entered?		Name/ID	
DOJ/NCIC Cancelled?		Name/ID	
APR Sent?		Name/ID	
APB Sent?		Name/ID	

Public Narrative

Summary of [REDACTED] statement.

Supervisor Approving

Approving Supervisor:	[REDACTED]
Date Reviewed:	8/20/2019 12:00:00 AM

Witness Information

[REDACTED]	[REDACTED]	[REDACTED]	[REDACTED]	[REDACTED]	[REDACTED]
[REDACTED]	[REDACTED]	[REDACTED]	[REDACTED]	[REDACTED]	[REDACTED]



Riverside Police Department

Officer Report

File Number:
190023109-041

[REDACTED]	[REDACTED]	[REDACTED]	[REDACTED]
[REDACTED]	[REDACTED]	[REDACTED]	[REDACTED]
[REDACTED]			

Witness Addresses:

[REDACTED]	[REDACTED]	[REDACTED]	[REDACTED]
[REDACTED]	[REDACTED]	[REDACTED]	[REDACTED]

Witness Phones:

[REDACTED]	[REDACTED]
[REDACTED]	[REDACTED]

Evidence Information

Physical Evidence Present?		Physical Evidence Seized?	
Photographs Taken?		Photographer?	
Weapon Seized?		Weapon(s) Taken For Safety?	
Gang Related?		Sensitive Data?	
Fingerprint Search Made?		Fingerprints Obtained?	
Narcotics Seized?		Narcotics Field Tested?	
Audio Recording Available?		In Car Recording Available?	
Body Worn Camera Recording Available?			
Type of Weapon, Force, Or Device Used?			
Motive:			

Narrative

- 1 On 8/12/19, I responded to Eastridge/Box Springs reference an Officer Involved Shooting
- 2 investigation. Detective [REDACTED] and I spoke to W [REDACTED]. W [REDACTED] was the driver of the black
- 3 Honda Accord, CA license plate: [REDACTED]. The conversation was audio recorded and retained in
- 4 police records. The following is a summary of his statement. Refer to recording for specific
- 5 information.
- 6
- 7 [REDACTED] told me his name, date of birth, address and phone number.
- 8



Riverside Police Department

Officer Report

File Number:
190023109-041

9 W [REDACTED] said he pulled up and saw they (*California Highway Patrol officers*) were trying to tow his
10 (*S/Luther's*) car. W [REDACTED] was going to Wal-Mart because he needed to get supplies to work on an
11 air conditioning unit at his work. He saw the tow truck driver react and thought, "What the fuck?" The
12 tow truck's flatbed was down and was scraping the pavement as it fled. W [REDACTED] wondered why it
13 was scraping and then saw a guy armed with an AR15 rifle. [REDACTED] thought the guy was
14 shooting .223 rounds by the way they sounded. He saw the male "buck" (*shoot*) into the police
15 officer's chest. He said the police officer did not see the guy grab the gun and the officer was just
16 standing there. The male grabbed the gun and started shooting. He saw an officer get hit twice and
17 saw the officer fall to the "floor" (*ground.*) The other "Highway Patrol" ran behind the car and began
18 shooting at the man. All of the officer's bullets landed on the ground because he was shooting
19 downhill. The officer was shooting so fast and the bullets were coming down. W [REDACTED] saw cars
20 turning around and could hear the bullets flying.

21
22 W [REDACTED] said it looked like the male was trying to "pick off cops." The male "popped" into the
23 corner and shot at the cop on the "floor" (*ground*). W [REDACTED] said, "Pow, pow, pow, pow!" The
24 "Highway Patrol" shot the suspect in the leg and another "Highway Patrol" pulled up right next to
25 the male. The male shot three rounds into the windshield. The officer was still inside the car. The
26 officer then backed up, exited the car, fixed his glasses and ran behind a car to assist. The male
27 continued to shoot; he continued to "let off" rounds. W [REDACTED] thought the male was hit in the
28 stomach because [REDACTED] saw him kneel down. The male did not look scared; he just took a deep
29 breath and lifted the gun up again.

30
31 W [REDACTED] described officers from the Sheriff's Department and Riverside Police Department
32 arriving. He said "#048" with three stripes on his arm got the confirmed "kill" on the male. [REDACTED]
33 *refers to the male suspect, later identified as Aaron Luther, as the victim throughout his statement.*)
34 [REDACTED] described the Riverside Police Department Officer shooting through W [REDACTED] car
35 window. He said he looked to the side and saw a shot from the Riverside Police Department officer
36 hit the male. Another officer was shooting from the Jeep but was not making "confirmed" shots. The
37 second shot from the RPD officer also hit the male and the male fell sideways and then just laid there
38 on his side. W [REDACTED] thought the male was dead but said he heard he was not.

39
40 W [REDACTED] saw officers forming up behind the Jeep. One officer was by W [REDACTED] car window.
41 W [REDACTED] told us he could not exit his vehicle. There were more cars behind him. He said once the
42 male was shot everything slowed down and he saw many officers arriving.

43
44 W [REDACTED] described the male as an "old school motor cycle rider." He seemed experienced with
45 shooting the gun. W [REDACTED] described the male as knowing what he was doing. He further
46 described the male as tall, skinny with gray/white hair and balding on top. The male had some facial
47 hair and looked like he was on the verge of being homeless or possibly living out of his car. The male
48 was wearing shorts and a white T-shirt. W [REDACTED] did not see if the male had any tattoos.

49 W [REDACTED] recognized the male's gun as an AR15 because he had some experience with firearms
50 and had shot different types of weapons.

51

Date Printed: 10/27/2022 3:06 PM	Case Report Number: 190023109-041	Page: 3 of 4	Ver. 1.3.3
-------------------------------------	--------------------------------------	-----------------	---------------



Riverside Police Department

Officer Report

File Number:
190023109-041

52 W [REDACTED] said the male (*later identified as suspect Aaron Luther*) was outside of his truck and pulled
53 the weapon from the "trunk" and started "bucking" (*shooting*) at cops. The cops returned fire. The
54 suspect hit one officer and the officer limped behind the truck. One officer was on the "floor" laying
55 down with his arm up shooting. He saw the officer reload and shoot again. He thought the officer
56 rapidly shot six rounds after the reload. The suspect shot and continued to shoot down the hill.

57
58 W [REDACTED] heard bullets flying by and tried to get other driver's attention to stop them from driving
59 toward the shooting. He saw people with kids and told them to turn around. Someone asked him
60 why and he told them, "Hear that?; Go!" W [REDACTED] said the suspect did not say anything. The
61 suspect saw people passing but he did not point the gun at them. He only pointed the gun at cops.
62 [REDACTED] said the suspect started the whole thing. CHP did not do anything wrong; they were just
63 impounding the suspect's car. W [REDACTED] said he thought the suspect started shooting at the police
64 because of the impound.

65
66 W [REDACTED] told us a Riverside Police Department officer with three stripes on his "regular blue"
67 uniform shot the suspect. The officer used the window of W [REDACTED] vehicle and shot the suspect.
68 The suspect was hit in the side. There were other officers by the Jeep shooting but they were not
69 hitting the suspect. The suspect went down after the RPD officer's second shot and stayed down near
70 the back tire on the left side. W [REDACTED] thought it was over and he saw all the other officers from
71 different agencies stacking up on the corner.

72
73 W [REDACTED] was not hurt and his vehicle was not hit. He talked about wanting his vehicle to be out of
74 the scene. He had children, two jobs and needed to get home.

75
76 He said he saw two CHP cars "back to back" behind the suspect's truck when the shooting started.
77 The CHP officers were scared. The suspect was shooting a rifle and the officers were shooting
78 handguns. He said it was hard to battle a rifle with pistols. Another CHP car pulled up and the
79 suspect shot three times at the windshield. They pulled up close to the suspect and he stepped back
80 and shot three times. The officer backed up, exited and ran behind the car.

81
82 W [REDACTED] said when he called 911 he told them to direct the police to come to Eastridge/Box
83 Springs to approach so they could get behind the suspect. He mentioned there was only so much
84 cover the officers had laying down behind cars. He saw two CHP officers shooting at the suspect
85 from the "front" and described it like the suspect shooting as if he was "paint balling."

86
87 W [REDACTED] told us it was not the CHP's fault. The suspect shot at the cops and the cops were just
88 doing their job. W [REDACTED] pointed out the two tow truck drivers to me. He said there was an Omni
89 bus coming up the hill at the time of the shooting. The bus came "face to face" with the suspect. The
90 bus turned and hit a rail. The suspect looked at the bus and turned his attention back toward the
91 police. He said the suspect could have shot civilians because they were going up the hill "like crazy."
92 He said every time the suspect saw police he shot. He described the two CHP police cars on the
93 scene as an SUV and a Charger.

94

Date Printed: 10/27/2022 3:06 PM	Case Report Number: 190023109-041	Page: 4 of 5	Ver. 1.3.3
--	---	------------------------	----------------------



Riverside Police Department

Officer Report

File Number:
190023109-041

95 I gave him my business card and told him we would call him and let me know when he could pick up
96 his car. He asked me if an officer died and I told him one officer died. He said he saw two at first and
97 one hid behind a vehicle. He said maybe the suspect hit the officer in the head and the officer fell
98 between the cars. The suspect stepped between the cars and shot when the other CHP officers
99 pulled up. W/ [REDACTED] thought someone died because the suspect backed up and was waiting for
100 more cops. W/ [REDACTED] thought one officer was hit in the chest and neck. He saw two cops get shot
101 and he did not know if the third one who pulled up was shot or not.

102
103 W/ [REDACTED] said the shooting was like the LA bank robbery because the suspect kept grabbing
104 bullets. W/ [REDACTED] thought the suspect might kill himself because "he was going to die anyway." He
105 told me his car was not hit and asked me to turn off the engine. He again said it was not the cops
106 fault; it was the suspect's fault. The suspect shot and they retaliated on him. He said it was too late;
107 they (*the officers*) were standing around watching him (*the suspect*). The suspect was complying and
108 the officers did not have any fear. They allowed him to get his belongings. The tow truck was there
109 and putting the crank down. The suspect shot and the tow truck driver took off. The suspect
110 continued to fire rounds and W/ [REDACTED] could hear the sounds of the echoing shots. He was sure
111 the suspect's gun was an AR15. It was not an automatic. It was a single pull trigger. W/ [REDACTED]
112 thought the second officer to pull up was going to lose his life.

113
114 W/ [REDACTED] denied taking any video of the shooting. He told me his phone had a dead battery. (*I met*
115 *with him on 8/15/19 at Magnolia Station to release his vehicle to him. He admitted he did video the*
116 *incident and agreed to provide me with the video.*) He told me [REDACTED] was there and assisted
117 officers in pulling cops out of the way. He saw them pull an officer to the back of a car and [REDACTED]
[REDACTED] had his camera with him. [REDACTED] is a freelance photographer. He provides photos to the
118 media.)

119
120
121 W/ [REDACTED] told us he asked the 911 dispatcher if he could "throw his car into him" (*the suspect*). He
122 told her he could "smash" him from the back. The dispatcher would not "confirm" for him to hit the
123 suspect with his car. W/ [REDACTED] thought the suspect was so old and was not able to turn fast
124 enough. He said he told the dispatcher the cops were in trouble and asked her three times if he
125 could hit him with his car. She told him not to hit the suspect but to find cover. He told her the cops
126 were getting shot and he could throw his car into him. She told him not to do it.

127
128 He said the RPD officer told him to get out of the car and he did not do it because bullets were
129 coming down the hill toward him. He said there should be nothing negative toward the cops
130 because the suspect was shooting at them. He talked about cars stopping to watch. He told them to
131 leave. He said he heard a lady's car was hit. He saw a car get hit as it was turning. He said the CHP
132 officers were shooting from the "floor" up. He talked about saving another man's life by getting him
133 to safety.

134
135 The interview was concluded.

136

Date Printed: 10/27/2022 3:06 PM	Case Report Number: 190023109-041	Page: 5 of 6	Ver. 1.3.3
-------------------------------------	--------------------------------------	-----------------	---------------



Riverside Police Department

Officer Report

File Number:
190023109-041

137 I released W/ [REDACTED] vehicle to him on 8/14/19 from Magnolia Police Station. I confronted him
138 about a posted social media video and he admitted he did video tape parts of the incident. He
139 agreed to send me any additional videos he had. He also told me he did not see CHP motorcycle at
140 the scene.

141
142
143
144

RIVERSIDE POLICE DEPARTMENT

Date Printed: 10/27/2022 3:06 PM	Case Report Number: 190023109-041	Page: 6 of 6	Ver. 1.3.3
-------------------------------------	--------------------------------------	-----------------	---------------



Riverside Police Department

Officer Report

File Number:
190023109-042

Administrative Information

Subject:		1111 - OFFICER NEEDS BACK-UP/URGENT RESPONSE			
Date(s) and Time(s) of Occurrence Or Between:		//			
Location Of Occurrence:		Box Springs Bldg / Eastridge Ave RIVERSIDE			
Date/Time Reported:	8/12/2019 5:38:06 PM	Day:			
Date Of Report:	8/14/2019 1:02:26 PM	Type Of Premises:			
NPC:		RD:	PG08	Beat:	3
Was There a Witness To The Crime?					
Can a Suspect Be Named Or Identified?		By Whom?			
Can a Suspect Vehicle Be Identified?		By Whom?			

Code Section Classification:

Offense	Code Section
MURDER	187(A)
Completed	Yes

Records Section

Reporting Officer:	[REDACTED]		
115 Qualified:	Yes		
Send Copies Of This Report To:			
DOJ/NCIC Entered?		Name/ID	
DOJ/NCIC Cancelled?		Name/ID	
APR Sent?		Name/ID	
APB Sent?		Name/ID	

Public Narrative

--	--

Supervisor Approving

Approving Supervisor:	[REDACTED]
Date Reviewed:	8/19/2019 12:00:00 AM



Riverside Police Department

Officer Report

File Number:
190023109-042

Evidence Information

Physical Evidence Present?		Physical Evidence Seized?	
Photographs Taken?		Photographer?	
Weapon Seized?		Weapon(s) Taken For Safety?	
Gang Related?		Sensitive Data?	
Fingerprint Search Made?		Fingerprints Obtained?	
Narcotics Seized?		Narcotics Field Tested?	
Audio Recording Available?		In Car Recording Available?	
Body Worn Camera Recording Available?			
Type of Weapon, Force, Or Device Used?			
Motive:			

Narrative

1 **NARRATIVE:**

2 On August 12, 2019, at approximately 1830 hours, I received a phone call from Supervising Forensic
3 Specialist, [REDACTED]. SFS [REDACTED] told me there was an officer involved
4 shooting On Eastridge Avenue, near the 215 Freeway and the command post was on Eastridge Avenue
5 near Box Springs Blvd. I was requested to assist with the Evidence Team by taking photographs of the
6 scene as needed.

7 At approximately 1910 hours I arrived at the command post. Eventually the determination was made by
8 the command of the various agencies involved, to wait until daybreak to process the scene. At
9 approximately 2030 hours I left the scene and drove to Magnolia Station. Just as I arrived at the station, I
10 received a phone call from Senior Forensic Specialist [REDACTED] requesting me to return to the scene
11 and contact Detective [REDACTED]

12 At approximately 2335 hours I arrived back at the scene, where Detective [REDACTED], asked me to
13 photograph a tow truck and a projectile that were in the parking lot of Mayesh Wholesale Florist, INC.,
14 located at 2295 Eastridge Avenue, Riverside, CA. Additionally, I was asked to collect the projectile as
15 evidence.

16 The tow truck (California Plate: [REDACTED]), was on the east side of the business' north parking lot. Per
17 Detective [REDACTED] the tow truck was driven into the parking lot after the shooting had occurred. The
18 projectile was located approximately 74' east and 43' 6" south, of a fire hydrant which located on the east
19 side of Box Springs Blvd, south of Eastridge Avenue. I photographed the evidence item and tow truck as
20 requested. I collected the projectile as evidence on August 13, 2019 at approximately 0021 hours. At
21 approximately 0055 hours, I cleared the location and transported the evidence to the Magnolia Street
22 Station where I secured the item until I could process it as evidence. (On August 15, 2019, at



Riverside Police Department

Officer Report

File Number:
190023109-042

23 approximately 1050 hours, while at the Magnolia Street Station, I processed and placed the above
24 referenced evidence item as GEA001 into Property Locker #41.)

25 On August 13, 2019, at approximately 0600 hours, I went to the command post to help photograph the
26 crime scene and collect evidence. Throughout the day I photographed vehicles and evidence items as
27 requested by the investigative team. Note photos of the ground with no evidence, prior to photos taken in
28 a circular pattern, are reference points of approximately where I stood (Photos: J8E61126, J8E61135,
29 J8E61147 and J8E61148). Additionally, I assisted from Senior Forensic Specialist [REDACTED] while she
30 collected evidence items. I cleared crime scene the location on August 14, 2019 at approximately 0355
31 hours.

32 I was the only photographer to use my camera during the crime scene investigation and I was the only
33 person who took photos with my camera. Due to the size of the crime scene and lighting issues at night,
34 some settings created grainy images. The first image I took was loaded into DIMS as J8E60730 and the
35 last photo taken was J8E61457. On August 14, 2019, I downloaded 728 photos into the Riverside Police
36 Department, Digital Image Management System (DIMS) which is a secure file format photo repository.
37 The download took over an hour and ended at approximately 1535 hours.

38 **NOTE:** All photograph times are off by one hour. The camera settings were not set for Daylight Savings
39 Time and the camera will indicate the time is one hour earlier than it actually is. Example, the time on the
40 camera indicates 1301 hours, when the time is actually 1401 hours. This may affect the date for
41 photographs taken within one hour of midnight.

42

43

RIVERSIDE POLICE DEPARTMENT

Date Printed: 10/27/2022 3:07 PM	Case Report Number: 190023109-042	Page: 3 of 3	Ver. 1.3.3
-------------------------------------	--------------------------------------	-----------------	---------------



Riverside Police Department

Officer Report

File Number:
190023109-043

Administrative Information

Subject:	1111 - OFFICER NEEDS BACK-UP/URGENT RESPONSE				
Date(s) and Time(s) of Occurrence Or Between:	//				
Location Of Occurrence:	Box Springs Bldg / Eastridge Ave RIVERSIDE				
Date/Time Reported:	8/12/2019 5:38:06 PM	Day:			
Date Of Report:	8/14/2019 1:52:03 PM	Type Of Premises:			
NPC:		RD:	PG08	Beat:	3
Was There a Witness To The Crime?					
Can a Suspect Be Named Or Identified?			By Whom?		
Can a Suspect Vehicle Be Identified?			By Whom?		

Code Section Classification:

Records Section

Reporting Officer:	[REDACTED]		
115 Qualified:	Yes		
Send Copies Of This Report To:			
DOJ/NCIC Entered?		Name/ID	
DOJ/NCIC Cancelled?		Name/ID	
APR Sent?		Name/ID	
APB Sent?		Name/ID	

Public Narrative

On 08-13-19, at approximately 1610 hours, while on uniformed patrol in a black and white police vehicle, in the City and County of Riverside, I responded to the area of Box Springs Boulevard and Eastridge Avenue to assist in an on-going investigation.

Supervisor Approving

Approving Supervisor:	[REDACTED]
Date Reviewed:	8/15/2019 12:00:00 AM

Evidence Information



Riverside Police Department

Officer Report

File Number:
190023109-043

Physical Evidence Present?		Physical Evidence Seized?	
Photographs Taken?		Photographer?	
Weapon Seized?		Weapon(s) Taken For Safety?	
Gang Related?		Sensitive Data?	
Fingerprint Search Made?		Fingerprints Obtained?	
Narcotics Seized?		Narcotics Field Tested?	
Audio Recording Available?		In Car Recording Available?	
Body Worn Camera Recording Available?			
Type of Weapon, Force, Or Device Used?			
Motive:			

Narrative

1 **Narrative:**
2 On 08-13-19, at approximately 1610 hours, while on uniformed patrol in a black and white
3 police vehicle, in the City and County of Riverside, I responded to the area of Box Springs
4 Boulevard and Eastridge Avenue to assist in an on-going investigation.
5
6 Upon arrival, I took a perimeter position on Box Springs Blvd, south of the intersection of
7 Eastridge Av. I relieved Officer [REDACTED] and Officer [REDACTED]. I assumed the Riverside
8 Police Department Major Incident Log from Officer [REDACTED], and I ensured no unauthorized
9 persons entered the crime scene. I maintained the log until the scene was clear.
10
11 Per Detective [REDACTED] I filled out nine CHP 180 Forms for vehicles which were involved in the
12 incident. I gave the CHP 180 Forms to Detective [REDACTED] after I completed the forms.
13
14 I was relieved from my position by Sergeant [REDACTED] at approximately 0345 on 08-14-19. I
15 booked the Riverside Police Department Major Incident Log at the Orange Police Station as
16 evidence.
17
18 See additional reports for further information. No further information.
19



Riverside Police Department

Officer Report

File Number:
190023109-044

Administrative Information

Subject:	187 PC, Murder				
Date(s) and Time(s) of Occurrence Or Between:	//				
Location Of Occurrence:	Box Springs Bldg / Eastridge Ave RIVERSIDE				
Date/Time Reported:	8/12/2019 5:38:06 PM	Day:			
Date Of Report:	8/13/2019 2:04:51 PM	Type Of Premises:			
NPC:		RD:	PG08	Beat:	3
Was There a Witness To The Crime?					
Can a Suspect Be Named Or Identified?			By Whom?		
Can a Suspect Vehicle Be Identified?			By Whom?		

Code Section Classification:

Records Section

Reporting Officer:	[REDACTED]		
115 Qualified:	Yes		
Send Copies Of This Report To:			
DOJ/NCIC Entered?		Name/ID	
DOJ/NCIC Cancelled?		Name/ID	
APR Sent?		Name/ID	
APB Sent?		Name/ID	

Public Narrative

Supplemental Report

Supervisor Approving

Approving Supervisor:	[REDACTED]
Date Reviewed:	8/15/2019 12:00:00 AM

Evidence Information

Physical Evidence Present?		Physical Evidence Seized?	
----------------------------	--	---------------------------	--



Riverside Police Department

Officer Report

File Number:
190023109-044

Photographs Taken?		Photographer?	
Weapon Seized?		Weapon(s) Taken For Safety?	
Gang Related?		Sensitive Data?	
Fingerprint Search Made?		Fingerprints Obtained?	
Narcotics Seized?		Narcotics Field Tested?	
Audio Recording Available?		In Car Recording Available?	
Body Worn Camera Recording Available?			
Type of Weapon, Force, Or Device Used?			
Motive:			

Narrative

- 1 Narrative::
- 2 On 08/12/19, at about 1738 hours, RPD Dispatch broadcasted an "'11-11" request for assistance
- 3 from CHP Officers who were being fired upon, at Eastridge Ave and the 215 Frwy. I responded and
- 4 arrive on scene at about 1750 hours. Just prior to arriving at the scene, I heard that the suspect was
- 5 down. I took up a traffic control / crime scene control position at the intersection of Box Springs and
- 6 Eastridge. At approximately 1836 hours, I began a crime scene log of the west side of the scene, of
- 7 personnel who were both already inside the crime scene, and then arrived later to assist with the
- 8 subsequent investigation. I have attached the crime scene log to this report. I remained on the scene
- 9 and maintained the log until I was relieved by RPD Officer [REDACTED] at 0145 hours.
- 10



Riverside Police Department

Officer Report

File Number:
190023109-045

Administrative Information

Subject:	1111 - OFFICER NEEDS BACK-UP/URGENT RESPONSE				
Date(s) and Time(s) of Occurrence Or Between:	8/12/2019 5:38:06 PM //				
Location Of Occurrence:	Box Springs Bldg / Eastridge Ave RIVERSIDE				
Date/Time Reported:	8/12/2019 5:38:06 PM	Day:	Monday		
Date Of Report:	8/14/2019 3:48:42 PM	Type Of Premises:			
NPC:		RD:	PG08	Beat:	3
Was There a Witness To The Crime?					
Can a Suspect Be Named Or Identified?		By Whom?			
Can a Suspect Vehicle Be Identified?		By Whom?			

Code Section Classification:

Records Section

Reporting Officer:	[REDACTED]				
115 Qualified:	Yes				
Send Copies Of This Report To:					
DOJ/NCIC Entered?		Name/ID			
DOJ/NCIC Cancelled?		Name/ID			
APR Sent?		Name/ID			
APB Sent?		Name/ID			

Public Narrative

Supervisor Approving

Approving Supervisor:	[REDACTED]				
Date Reviewed:	8/20/2019 12:00:00 AM				

Evidence Information

Physical Evidence Present?		Physical Evidence Seized?	
----------------------------	--	---------------------------	--



Riverside Police Department

Officer Report

File Number:
190023109-045

Photographs Taken?		Photographer?	
Weapon Seized?		Weapon(s) Taken For Safety?	
Gang Related?		Sensitive Data?	
Fingerprint Search Made?		Fingerprints Obtained?	
Narcotics Seized?		Narcotics Field Tested?	
Audio Recording Available?		In Car Recording Available?	
Body Worn Camera Recording Available?			
Type of Weapon, Force, Or Device Used?			
Motive:			

Narrative

1 RSO Report #MC192240004

2

3 On Monday, August 12th at approximately 1920 hours, I was contacted by Sgt.
4 [REDACTED] to see if I would be able to assist in the investigation. Sgt. [REDACTED]
5 requested I respond to the Riverside University Health System (RUHS) Medical
6 Center to act as a Liaison amongst the other departments who were involved in
7 the investigation. When I arrived at RUHS, I contacted Detective [REDACTED] in the
8 Emergency Room.

9 While I was in the Emergency Room, I was told that a CHP Officer was in
10 possession of CHP Officer Moye's duty weapon and CHP Officer [REDACTED] Sam
11 Browne. I was directed to contact RSO Deputy [REDACTED] who could put
12 me in touch with that CHP Officer. Deputy [REDACTED] advised that CHP Officer [REDACTED]
13 [REDACTED] was in possession of the gear. Deputy [REDACTED] advised he
14 would be taking a report documenting his involvement in the investigation as
15 well as the chain of custody of the CHP Officers' equipment.

16 I then contacted CHP Officer [REDACTED] who was in the parking lot of RUHS
17 Emergency Room. Officer [REDACTED] said he was given CHP Officer Moye's
18 handgun and CHP Officer [REDACTED] Sam Browne. Officer [REDACTED] advised each
19 item was placed in separate bags and being stored inside his CHP patrol car. I
20 advised Officer [REDACTED] to keep the items inside his patrol car, until we were
21 ready and able to collect the items. The items remained inside his patrol car
22 until we collected them.



Riverside Police Department

Officer Report

File Number:
190023109-045

23 Later in the evening, I contacted Officer [REDACTED] and advised him we were
24 ready to collect the items. Officer [REDACTED] took us to his patrol car. Officer
25 [REDACTED] removed a bag which contained Officer Moye's handgun. Officer
26 [REDACTED] removed the magazine from the handgun and handed it over to
27 Evidence Tech [REDACTED] and myself. Officer [REDACTED] then rendered the handgun
28 safe by locking the slide to the handgun back and allowing the bullet to eject
29 from the chamber. The handgun and single bullet were handed over to us.
30 Evidence Tech [REDACTED] took photographs of the items and took possession of
31 them.

32 Officer [REDACTED] then handed over CHP Officer [REDACTED] Sam Browne. Evidence
33 Tech [REDACTED] took photographs of the equipment and took possession of the
34 items.

35

RIVERSIDE POLICE DEPARTMENT

Date Printed: 10/27/2022 3:11 PM	Case Report Number: 190023109-045	Page: 3 of 3	Ver. 1.3.3
-------------------------------------	--------------------------------------	-----------------	---------------



Riverside Police Department

Officer Report

File Number:
190023109-046

Administrative Information

Subject:	1111 - OFFICER NEEDS BACK-UP/URGENT RESPONSE				
Date(s) and Time(s) of Occurrence Or Between:	//				
Location Of Occurrence:	Box Springs Bldg / Eastridge Ave RIVERSIDE				
Date/Time Reported:	8/12/2019 5:38:06 PM	Day:			
Date Of Report:	8/14/2019 3:56:29 PM	Type Of Premises:			
NPC:		RD:	PG08	Beat:	3
Was There a Witness To The Crime?					
Can a Suspect Be Named Or Identified?		By Whom?			
Can a Suspect Vehicle Be Identified?		By Whom?			

Code Section Classification:

Records Section

Reporting Officer:	[REDACTED]		
115 Qualified:	Yes		
Send Copies Of This Report To:			
DOJ/NCIC Entered?		Name/ID	
DOJ/NCIC Cancelled?		Name/ID	
APR Sent?		Name/ID	
APB Sent?		Name/ID	

Public Narrative

Supervisor Approving

Approving Supervisor:	[REDACTED]
Date Reviewed:	8/15/2019 12:00:00 AM

Witness Information

Code:		Name:	[REDACTED]
[REDACTED]	[REDACTED]	[REDACTED]	[REDACTED]



Riverside Police Department Officer Report

File Number:
190023109-046

[REDACTED]

Notes:

Witness Addresses:

[REDACTED]	[REDACTED]	[REDACTED]	[REDACTED]
[REDACTED]	[REDACTED]	[REDACTED]	[REDACTED]

Witness Phones:

[REDACTED]	[REDACTED]
[REDACTED]	[REDACTED]

Witness Information

[REDACTED]	[REDACTED]	[REDACTED]	[REDACTED]
[REDACTED]	[REDACTED]	[REDACTED]	[REDACTED]

Notes:

Witness Addresses:

[REDACTED]	[REDACTED]	[REDACTED]	[REDACTED]
[REDACTED]	[REDACTED]	[REDACTED]	[REDACTED]

Witness Phones:

[REDACTED]	[REDACTED]
[REDACTED]	[REDACTED]

Witness Information

[REDACTED]	[REDACTED]	[REDACTED]	[REDACTED]
[REDACTED]	[REDACTED]	[REDACTED]	[REDACTED]

Notes:

Witness Addresses:



Riverside Police Department

Officer Report

File Number:
190023109-046

██████████	██████████	██████████	██████████
██████████	██████████	██████████	██████████

Witness Phones:

██████████	██████████
██████████	██████████

Evidence Information			
Physical Evidence Present?		Physical Evidence Seized?	
Photographs Taken?		Photographer?	
Weapon Seized?		Weapon(s) Taken For Safety?	
Gang Related?		Sensitive Data?	
Fingerprint Search Made?		Fingerprints Obtained?	
Narcotics Seized?		Narcotics Field Tested?	
Audio Recording Available?		In Car Recording Available?	
Body Worn Camera Recording Available?			
Type of Weapon, Force, Or Device Used?			
Motive:			

Narrative

1 **Case Assignment:**
2
3 I am a Detective for the Riverside Police Department, currently assigned to the Special Investigations
4 Bureau – Vice Unit. On 08-12-19 at approximately 2200 hours, Sgt. ██████████ contacted me and requested
5 that I respond to Eastridge Ave. and Box Springs Rd. to assist with an officer involved shooting incident
6 that occurred. This incident initiated at approximately 1738 hours, in the westbound number two lane of
7 Eastridge Ave. just east of Box Springs Rd.
8
9 **Investigation:**
10
11 At approximately 2240 hours, I arrived at the command post located in the area of Box Springs Rd. and
12 Eastridge Ave. I contacted Sgt. ██████████ and was directed to examine a tow truck that was located in the
13 front parking lot of 2295 Eastridge Ave. I checked the vehicle for strike-marks or any signs that it had
14 been struck by gunfire. I did not locate any damage to the vehicle consistent with being struck by gunfire.
15 After examining the vehicle for physical evidence, I was directed by Sgt. ██████████ to contact potential
16 witnesses located on the southbound 215-freeway onramp on Eucalyptus Ave. I responded to the onramp
17 and contacted a group of several possible witnesses.



Riverside Police Department

Officer Report

File Number:
190023109-046

18
19
20
21
22
23
24
25
26
27
28
29
30
31
32
33
34
35
36
37
38
39
40
41
42
43
44
45
46
47
48
49
50
51
52
53
54
55
56
57
58
59
60
61
62
63
64

Interview with [REDACTED]

This interview took place near the onramp for the 215-freeway on Eucalyptus Ave. [REDACTED] was separated from other potential witnesses and our conversation was audio recorded. The following is a summary of [REDACTED] statements as to the events that transpired earlier in the day:

[REDACTED] was traveling south on the 215 freeway approaching the exit for Eucalyptus Ave. / Eastridge Ave. As he entered the onramp and approached Eastridge Ave., he noticed the vehicles in front of him were slowing down. He looked in a westbound direction and noticed a white male adult, with dark long hair and a black shirt, standing near a parked vehicle. He said the white male adult appeared to be removing items from the passenger side of the parked vehicle. He recalled seeing a CHP Officer on a motorcycle contacting the white male adult. Shortly after the CHP Officer contacted the white male adult, the white male adult retrieved a gun and shot the CHP Officer one time.

[REDACTED] said a second CHP Officer arrived in a SUV and was fired at by the white male adult. He watched as the white male adult used the parked vehicle as cover while the officer returned fire. At one point, he observed the white male adult advancing toward the front of the officer's SUV. He said the white male adult used the officer's SUV as cover while he fired at additional police vehicles that arrived at the scene. He could not recall the number of times the white male adult fired his weapon but said the white male adult did reload his weapon at least two times. He watched as a group of officers approached the white male adult. He also noticed two officers that were down on the ground. [REDACTED] said the group of officers rescued the downed officers and pulled them out of the area.

[REDACTED] felt the entire incident lasted approximately 25 minutes. He watched as the officers approached the white male adult but did not actually see the white male adult be shot by any of the officers. He said it appeared as though officers were tending to the white male adult medically. He was unable to provide any additional information regarding the incident.

Interview with [REDACTED]

This interview took place near the onramp for the 215-freeway on Eucalyptus Ave. [REDACTED] was separated from other potential witnesses and our conversation was audio recorded. The following is a summary of [REDACTED] statements as to the events that transpired earlier in the day:

She was traveling westbound on Eucalyptus Ave. when she stopped at the red light at Valley Springs Pkwy. There was a trailer in front of her while she was stopped at the light. She heard what she recalled as a popping sound and thought the sound was coming from the trailer that was in front of her (possible backfire). When the light turned green, she continued westbound on Eucalyptus Ave. approaching the southbound 215-freeway off-ramp. At that time, she observed the shooting directly in front of her. She was still facing westbound at this time but said she ducked down inside of her vehicle. She maneuvered her vehicle down the off-ramp in an effort to get to safety. She noticed that the shooting stopped and started again three different times. She never saw the "gunman" and only observed one officer as he dove behind a vehicle. She was unable to provide any further details regarding the incident.

[REDACTED] :



Riverside Police Department

Officer Report

File Number:
190023109-046

65 This interview took place near the onramp for the 215-freeway on Eucalyptus Ave. [REDACTED] was separated
66 from other potential witnesses and our conversation was audio recorded. The following is a summary of
67 [REDACTED] statements as to the events that transpired earlier in the day:

68
69 He was the front passenger in a vehicle traveling southbound on the 215-freeway. As they exited the
70 freeway at Eastridge Ave. he heard a woman yelling and gunshots. He quickly exited the vehicle he was
71 in and ran down the off-ramp toward the freeway. He saw the "shooter" and described him as a tall guy
72 wearing a hat and a black shirt. He observed the "shooter" reloading his weapon. He also saw one officer
73 fire in the direction of the "shooter." He felt the "shooter" fired more than twenty times. He was unable to
74 provide any additional information regarding the incident.

75
76 **Case Disposition:**

77
78 This investigation is ongoing.
79

RIVERSIDE POLICE DEPARTMENT

Date Printed: 11/1/2022 2:52 PM	Case Report Number: 190023109-046	Page: 5 of 5	Ver. 1.3.3
------------------------------------	--------------------------------------	-----------------	---------------



Riverside Police Department

Officer Report

File Number:
190023109-047

Administrative Information

Subject:	1111 - OFFICER NEEDS BACK-UP/URGENT RESPONSE				
Date(s) and Time(s) of Occurrence Or Between:	//				
Location Of Occurrence:	Box Springs Bldg / Eastridge Ave RIVERSIDE				
Date/Time Reported:	8/12/2019 5:38:06 PM	Day:			
Date Of Report:	8/14/2019 4:00:31 PM	Type Of Premises:			
NPC:		RD:	PG08	Beat:	3
Was There a Witness To The Crime?					
Can a Suspect Be Named Or Identified?			By Whom?		
Can a Suspect Vehicle Be Identified?			By Whom?		

Code Section Classification:

Records Section

Reporting Officer:	[REDACTED]		
115 Qualified:	Yes		
Send Copies Of This Report To:			
DOJ/NCIC Entered?		Name/ID	
DOJ/NCIC Cancelled?		Name/ID	
APR Sent?		Name/ID	
APB Sent?		Name/ID	

Public Narrative

Supervisor Approving

Approving Supervisor:	[REDACTED]
Date Reviewed:	8/20/2019 12:00:00 AM

Evidence Information

Physical Evidence Present?		Physical Evidence Seized?	
----------------------------	--	---------------------------	--



Riverside Police Department

Officer Report

File Number:
190023109-047

Photographs Taken?		Photographer?	
Weapon Seized?		Weapon(s) Taken For Safety?	
Gang Related?		Sensitive Data?	
Fingerprint Search Made?		Fingerprints Obtained?	
Narcotics Seized?		Narcotics Field Tested?	
Audio Recording Available?		In Car Recording Available?	
Body Worn Camera Recording Available?			
Type of Weapon, Force, Or Device Used?			
Motive:			

Narrative

- 1 On 08/12/19 at about 1930 hours, while assigned as a tactical flight officer in the aviation unit, I was
- 2 called to provide aerial security/surveillance at the scene of an officer involved shooting. Police Pilot
- 3 [REDACTED] were at RUHS hospital and not available to respond to the scene due to the
- 4 helicopter being held as part of a crime scene.
- 5
- 6 Police Pilot [REDACTED] and I logged in as "Air 2" and responded to the scene (at Eastridge and Box
- 7 Springs) in police helicopter "N951RP" at around 2131 hours. We stayed on scene until 2340 hours
- 8 and returned to the police hangar. We logged off at about 0027 hours after being notified that we
- 9 were no longer needed at the scene.
- 10



Riverside Police Department

Officer Report

File Number:
190023109-048

Administrative Information

Subject:	1111 - OFFICER NEEDS BACK-UP/URGENT RESPONSE				
Date(s) and Time(s) of Occurrence Or Between:	//				
Location Of Occurrence:	Box Springs Bldg / Eastridge Ave RIVERSIDE				
Date/Time Reported:	8/12/2019 5:38:06 PM	Day:			
Date Of Report:	8/14/2019 5:11:47 PM	Type Of Premises:			
NPC:		RD:	PG08	Beat:	3
Was There a Witness To The Crime?					
Can a Suspect Be Named Or Identified?			By Whom?		
Can a Suspect Vehicle Be Identified?			By Whom?		

Code Section Classification:

Records Section

Reporting Officer:	[REDACTED]		
115 Qualified:	Yes		
Send Copies Of This Report To:			
DOJ/NCIC Entered?		Name/ID	
DOJ/NCIC Cancelled?		Name/ID	
APR Sent?		Name/ID	
APB Sent?		Name/ID	

Public Narrative

I assisted with interviews of witnesses at the scene of an officer involved shooting.

Supervisor Approving

Approving Supervisor:	[REDACTED]
Date Reviewed:	8/15/2019 12:00:00 AM

Witness Information

Code:		Name:	[REDACTED]
[REDACTED]	[REDACTED]	[REDACTED]	[REDACTED]



Riverside Police Department

Officer Report

File Number:
190023109-048

Height:		Weight:	
Hair:		Eyes:	
Notes:			

Witness Addresses:

Address Type	Address	City, State ZIP	County

Witness Phones:

Witness Information

Code:					
Height:		Weight:			
Hair:		Eyes:			
Notes:					

Witness Addresses:

Address Type	Address	City, State ZIP	County

Witness Phones:

Witness Information

Code:		Name:			
Height:		Weight:			
Hair:		Eyes:			
Notes:					

Witness Addresses:

Address Type	Address	City, State ZIP	County



Riverside Police Department

Officer Report

File Number:
190023109-048

[REDACTED]	[REDACTED]	[REDACTED]	[REDACTED]
------------	------------	------------	------------

Witness Phones:

[REDACTED]	[REDACTED]
[REDACTED]	[REDACTED]

Witness Information

Code:	[REDACTED]	Name:	[REDACTED]
[REDACTED]	[REDACTED]	[REDACTED]	[REDACTED]
Height:	[REDACTED]	Weight:	[REDACTED]
Hair:	[REDACTED]	Eyes:	[REDACTED]
Notes:			

Witness Addresses:

Address Type	Address	City, State ZIP	County
[REDACTED]	[REDACTED]	[REDACTED]	[REDACTED]

Witness Phones:

[REDACTED]	[REDACTED]
[REDACTED]	[REDACTED]

Information

Physical Evidence Present?	[REDACTED]	Physical Evidence Seized?	[REDACTED]
Photographs Taken?	[REDACTED]	Photographer?	[REDACTED]
Weapon Seized?	[REDACTED]	Weapon(s) Taken For Safety?	[REDACTED]
Gang Related?	[REDACTED]	Sensitive Data?	[REDACTED]
Fingerprint Search Made?	[REDACTED]	Fingerprints Obtained?	[REDACTED]
Narcotics Seized?	[REDACTED]	Narcotics Field Tested?	[REDACTED]
Audio Recording Available?	[REDACTED]	In Car Recording Available?	[REDACTED]
Body Worn Camera Recording Available?	[REDACTED]		[REDACTED]
Type of Weapon, Force, Or Device Used?	[REDACTED]		
Motive:			



Riverside Police Department

Officer Report

File Number:
190023109-048

Narrative

1 Evidence:

2

3 Item #JPB1: CD containing video from W/ [REDACTED] cell phone

4 Item #JPB2: CD containing video from W/ [REDACTED] cell phone.

5

6 Narrative:

7

8 On Monday, 08/12/19, at approximately 2145 hours I received a telephone call from Sgt.
9 [REDACTED] to assist on an officer involved shooting that occurred at Eastridge Ave. / 215 freeway in
10 the City and County of Riverside. I responded to the location and contacted Sgt. [REDACTED] who
11 asked me to contact and interview several witnesses at the location.

12

13 I contacted W/ [REDACTED] who was standing by on the on ramp of the S/B 215 freeway and
14 Eastridge Ave. The following is a brief synopsis of a digitally recorded interview. W/ [REDACTED]
15 said she turned onto W/B Eucalyptus Ave. from an unknown street when she heard what she
16 thought was "Fire crackers." W/ [REDACTED] said she was not sure what she was hearing, so she
17 continued driving W/B (Eucalyptus turns into Eastridge Ave.). W/ [REDACTED] said vehicles began
18 honking and that is when she noticed a women on the corner. W/ [REDACTED] pointed to the corner of
19 Eastridge Ave. and the off ramp of the S/B 215 freeway. W/ [REDACTED] said the female then jumped
20 into a white car and sped off. W/ [REDACTED] said at that moment she knew it was gun fire, so she
21 ducked down in her vehicle. [REDACTED] said she called 911 to tell dispatch that she was in her
22 vehicle and that police were all around her. W/ [REDACTED] said she did not see anything, but heard the
23 gunfire. W/ [REDACTED] said once she saw the helicopter landing, she exited her vehicle and ran onto
24 the off ramp of the S/B 215 freeway.

25

26 W/ [REDACTED] pointed out her vehicle (Green 2013 Toyota Venza 4dr CA Lic# [REDACTED]), parked
27 on the overpass of the 215 freeway on Eastridge Ave. just East of the S/B 215 freeway off ramp.
28 Based on her vehicle being in the crime scene, W/ [REDACTED] made arrangements for a ride home.

29

30 I contacted W/ [REDACTED] who was standing by on the on ramp of the S/B 215 freeway and
31 Eastridge Ave. The following is a brief synopsis of a digitally recorded interview. W/ [REDACTED] said
32 he was exiting S/B 215 freeway at Eastridge Ave. heading into work at the Ralphs distribution
33 center. W/ [REDACTED] said he was stopped on the off ramp around 1730 hours to make a right.
34 W/ [REDACTED] said he saw the police cars stopped on the road. W/ [REDACTED] said he then noticed a car
35 backing up and yelling for him to move. W/ [REDACTED] said he turned down his music and that's
36 when he heard the gun shots. W/ [REDACTED] said he exited his vehicle and hid behind his truck.
37 W/ [REDACTED] said he could see the police officers standing behind the police car. W/ [REDACTED] said he
38 could then see the "assailant" standing between a white car and the motorcycle fire at the police
39 with an automatic weapon. W/ [REDACTED] said the cops could not move up to the others cops because
40 the "assailant" had them pinned.

41



Riverside Police Department

Officer Report

File Number:
190023109-048

42 [REDACTED] said he did not see any officers on the ground. W/[REDACTED] said the police and the
43 "assailant" just shot at each other for 10 to 15 minutes. He said at one point he saw the suspect
44 reloading his weapon. W/[REDACTED] said he noticed that backup arrived and they were dragging a
45 police officer back to them. He said later he saw them load one officer into a helicopter and
46 another officer into a vehicle. W/[REDACTED] said the suspect was going back and fourth between the
47 police cruiser and the white truck. He said he also saw the suspect put the gun on the hood of the
48 first police cruiser and continue to shoot at the police. W/[REDACTED] said the suspect had way more
49 fire power than the cops. W/[REDACTED] said he had video on his cell phone of the incident. He then
50 showed me three videos of the incident that he had recorded. [REDACTED] attempted several times
51 to send the videos to my department email, but was unsuccessful. Det. [REDACTED] and I
52 responded to W/[REDACTED] residence on 08/14/19 at approx.. 1400 hours and downloaded the
53 videos from his cell phone onto a laptop computer. The videos were later downloaded onto a
54 DVD.

56 W/[REDACTED] pointed out his white 2002 Ford Explorer Sport Trac pickup CA Lic# [REDACTED] that
57 was parked on the on ramp of the S/B 215 freeway. W/[REDACTED] vehicle was photographed and
58 he was released from the scene.

60 I contacted W/[REDACTED] who was standing by on the on ramp of the S/B 215 freeway and Eastridge
61 Ave. The following is a brief synopsis of a digitally recorded interview. W/[REDACTED] said he was
62 exiting S/B 215 freeway at Eastridge Ave. and make attempting to make a right turn when he
63 saw a woman screaming in the middle of the road. W/[REDACTED] said that is when he heard the first
64 shots. W/[REDACTED] said he began backing up on the off ramp, but had to stop because a vehicle was
65 blocking his way. W/[REDACTED] said he exited the vehicle with his son and his son's friend. W/[REDACTED]
66 said he went down the embankment on the freeway to hide. W/[REDACTED] said when the shooting
67 stopped he walked up to see what was happening and he noticed the "gunman" was reloading his
68 weapon. W/[REDACTED] said it was not over yet and he went down the embankment. W/[REDACTED] said he
69 saw the suspect standing in front of his white truck and start shooting again. W/[REDACTED] said he
70 came back up the embankment when the police said it was safe.

72 [REDACTED] pointed out his vehicle (white 2005 Chevy Astro van CA Lic [REDACTED], parked on
73 the on ramp of the S/B 215 freeway. W/[REDACTED] vehicle was photographed and he was released
74 from the scene.

76 I contacted W/[REDACTED] who was standing by on the on ramp of the S/B 215 freeway and
77 Eastridge Ave. The following is a brief synopsis of a digitally recorded interview. W/[REDACTED]
78 said she was exiting S/B 215 freeway at Eastridge Ave. and was going to make a right turn onto
79 Eastridge Ave. W/[REDACTED] a said she saw numerous cops and then she saw a man in all black
80 with a rifle / machine gun. W/[REDACTED] said she thought it was a cop and appeared to have
81 military training by his movements. W/[REDACTED] said she saw him standing next to a white truck
82 (Pointed out the suspect vehicle) and he started moving forward towards the cops.

83



Riverside Police Department

Officer Report

File Number:
190023109-048

84 W [REDACTED] said the suspect moved forward to the first police car and there was two police
85 officers behind a second police car. W [REDACTED] said when the suspect was not shooting at the
86 cops, he began to shoot everywhere else. W [REDACTED] said she saw numerous cops showing up
87 and then seeing cops falling down, like they were injured. She said she was worried because the
88 suspect had a machine gun and the cops only had handguns. W [REDACTED] said at one point she
89 got worried because she did not see where the suspect went. W [REDACTED] said she saw the cops
90 really attack and then she saw the helicopter arrive. W [REDACTED] said she had video taped the
91 incident on her cell phone.

92
93 W [REDACTED] said the suspect shot a lot and was doing a lot with his gun. W [REDACTED] then
94 emailed the videos from her cell phone to my department email address. The videos were later
95 loaded onto a DVD. W [REDACTED] pointed out her vehicle ([REDACTED])
[REDACTED] vehicle was photographed and she was released from the scene.

97 The DVD containing the videos from W [REDACTED] and W [REDACTED] was later booked into
98 evidence at Magnolia Police station. The digital recordings were later downloaded into the
99 PUMA system at Magnolia Police station.

100

RIVERSIDE POLICE DEPARTMENT

Date Printed: 10/27/2022 3:14 PM	Case Report Number: 190023109-048	Page: 6 of 6	Ver. 1.3.3
-------------------------------------	--------------------------------------	-----------------	---------------



Riverside Police Department

Officer Report

File Number:
190023109-049

Administrative Information

Subject:	1111 - OFFICER NEEDS BACK-UP/URGENT RESPONSE				
Date(s) and Time(s) of Occurrence Or Between:	//				
Location Of Occurrence:	Box Springs Bldg / Eastridge Ave RIVERSIDE				
Date/Time Reported:	8/12/2019 5:38:06 PM	Day:			
Date Of Report:	8/14/2019 6:30:13 PM	Type Of Premises:			
NPC:		RD:	PG08	Beat:	3
Was There a Witness To The Crime?					
Can a Suspect Be Named Or Identified?			By Whom?		
Can a Suspect Vehicle Be Identified?			By Whom?		

Code Section Classification:

Records Section

Reporting Officer:	[REDACTED]		
115 Qualified:	Yes		
Send Copies Of This Report To:			
DOJ/NCIC Entered?		Name/ID	
DOJ/NCIC Cancelled?		Name/ID	
APR Sent?		Name/ID	
APB Sent?		Name/ID	

Public Narrative

Officer involved shooting investigation.

Supervisor Approving

Approving Supervisor:	[REDACTED]
Date Reviewed:	8/19/2019 12:00:00 AM

Evidence Information

Physical Evidence Present?		Physical Evidence Seized?	
----------------------------	--	---------------------------	--



Riverside Police Department

Officer Report

File Number:
190023109-049

Photographs Taken?		Photographer?	
Weapon Seized?		Weapon(s) Taken For Safety?	
Gang Related?		Sensitive Data?	
Fingerprint Search Made?		Fingerprints Obtained?	
Narcotics Seized?		Narcotics Field Tested?	
Audio Recording Available?		In Car Recording Available?	
Body Worn Camera Recording Available?			
Type of Weapon, Force, Or Device Used?			
Motive:			

Narrative

1 **Evidence:**

2 Photographs of Officer [REDACTED]. The photographs were
3 uploaded into the DIMS system.

6 **Details:**

7 On August 12, 2019, I was assigned to the Riverside Police Gang Intelligence
8 Unit in the City and County of Riverside. I was contacted by phone regarding
9 an officer involved shooting that occurred in the area of Eastridge and Box
10 Springs. I was advised that the police helicopter had transported an injured CHP
11 officer to the Riverside county hospital located at 26520 Cactus in the City of
12 Moreno Valley. I responded to the hospital to contact the flight crew of the
13 police helicopter that transported the CHP officer.

14
15 Upon arrival, I contacted Officer [REDACTED] who were standing
16 on the helicopter pad near the emergency entrance to the hospital. Two
17 Riverside County Sheriff deputies had been assigned to secure the area of the
18 helicopter until it could be processed by forensics personnel at a later time. I
19 transported both Officer [REDACTED] and Officer [REDACTED] to the Riverside Police
20 Magnolia St. police station.

21
22 Once at the station Officer [REDACTED] was examined for any blood on his uniform.
23 Officer [REDACTED] did not have any blood on his clothing and told me he was piloting
24 the helicopter at the time of the incident. I took photographs of Officer [REDACTED]
25 and his uniform.



Riverside Police Department

Officer Report

File Number:
190023109-049

26
27 I then examined [REDACTED]. He advised me he had blood on his uniform
28 and showed me several areas on his pants and the sleeves of his long sleeve
29 shirt. I took photographs of Officer [REDACTED] and his uniform.

30
31 Both Officer [REDACTED] were transported to the Riverside Police
32 Aviation location. Officer [REDACTED] removed his clothing and it was collected by
33 Detective [REDACTED] (report for details)

34
35 I uploaded the photographs I took into the Riverside Police DIMS systems as
36 evidence.

37
38
39

RIVERSIDE POLICE DEPARTMENT

Date Printed: 10/27/2022 3:15 PM	Case Report Number: 190023109-049	Page: 3 of 3	Ver. 1.3.3
-------------------------------------	--------------------------------------	-----------------	---------------



Riverside Police Department

Officer Report

File Number:
190023109-050

Administrative Information

Subject:	1111 - OFFICER NEEDS BACK-UP/URGENT RESPONSE				
Date(s) and Time(s) of Occurrence Or Between:	//				
Location Of Occurrence:	Box Springs Bldg / Eastridge Ave RIVERSIDE				
Date/Time Reported:	8/12/2019 5:38:06 PM	Day:			
Date Of Report:	8/14/2019 8:54:20 PM	Type Of Premises:			
NPC:		RD:	PG08	Beat:	3
Was There a Witness To The Crime?					
Can a Suspect Be Named Or Identified?		By Whom?			
Can a Suspect Vehicle Be Identified?		By Whom?			

Code Section Classification:

Records Section

Reporting Officer:	[REDACTED]		
115 Qualified:	Yes		
Send Copies Of This Report To:			
DOJ/NCIC Entered?		Name/ID	
DOJ/NCIC Cancelled?		Name/ID	
APR Sent?		Name/ID	
APB Sent?		Name/ID	

Public Narrative

Supervisor Approving

Approving Supervisor:	[REDACTED]
Date Reviewed:	8/19/2019 12:00:00 AM

Evidence Information

Physical Evidence Present?		Physical Evidence Seized?	
----------------------------	--	---------------------------	--



Riverside Police Department

Officer Report

File Number:
190023109-050

Photographs Taken?		Photographer?	
Weapon Seized?		Weapon(s) Taken For Safety?	
Gang Related?		Sensitive Data?	
Fingerprint Search Made?		Fingerprints Obtained?	
Narcotics Seized?		Narcotics Field Tested?	
Audio Recording Available?		In Car Recording Available?	
Body Worn Camera Recording Available?			
Type of Weapon, Force, Or Device Used?			
Motive:			

Narrative

1 On 08/12/19, I was assigned as a Detective in the Gang Intelligence Unit at the Riverside Police
2 Department. 08/12/19 was a Monday, and was one of my regular days off. At approximately 1730
3 hours, I turned on my police radio and heard an incident unfolding. I heard radio traffic indicating
4 shots had been fired and that the incident had taken place near Eastridge St. and Box Springs Road
5 in Riverside. Detectives from the Gang Unit were called in to work to assist in the investigation.
6
7 At approximately midnight on 08/13/19, we were cleared to go home. Shortly after getting home I
8 received a text message from Det. [REDACTED] asking for help in securing part of the crime scene. Due to the
9 extraordinary amount of evidence amount of evidence at the scene, the decision was made to secure
10 it through the night time hours, so it could be thoroughly processed during day light hours. Det. [REDACTED]
11 and I responded to the scene, and remained there until we were relieved by Homicide detectives at
12 approximately 0700 hours on 08/13/19.
13
14 On 08/13/19, I received notification that a video containing footage of the shooting incident had
15 been posted to a Facebook account under the name of [REDACTED]. The video was accompanied
16 by a caption stating, "The riverside shootout my boii show off is crazy for recording this" and linked
17 another account by the name of [REDACTED]" at the end of the caption. I watched the video and
18 the following is a description of what takes place.
19 The video is 4 minutes and 31 seconds long. It captures portions of the shooting incident and was
20 shot from a vantage point west of the suspect vehicle. The first screen shown is a "Screen Recording"
21 control screen which is common among newer iPhones. Based on the presence of this screen, I know
22 the video was seen and eventually recorded by someone other than the person who originally filmed
23 it. The video was then reposted on the [REDACTED]" account.
24
25 Visible on the screen in the upper left hand corner is an emoji of a male subject with dark colored
26 hair which is styled in a top knot. The emoji is wearing glasses and a red shirt. The name next to the



Riverside Police Department

Officer Report

File Number:
190023109-050

27 emoji reads, "Show Off". This video was originally live streamed on an Instagram account under the
28 name of "Show Off", seen by someone else, who then sent it to or had [REDACTED] record it.

29
30 The audio on the video starts at the 6 second mark. The narrator first states "He's shooting, cuz" at
31 the 14 second mark. Seen in the video are a white truck, followed by a marked police SUV, and a
32 second police vehicle. (Based on the time I spent securing the scene, I know a CHP motorcycle is
33 parked directly behind the white truck, but the video is shot from an angle in which the motorcycle is
34 totally blocked by the white truck.) There is what appears to be a white male wearing a black shirt
35 and possibly grey shorts standing next to the driver side door of the white truck. This subject is later
36 identified as the suspect, S/Luther. The suspect is facing eastbound (away from the camera, toward
37 the police vehicles), and appears to be holding something with both hands. He can be seen moving
38 in a manner similar to ducking and taking cover behind the truck. At the 15 second mark, a gunshot
39 can be heard. Three to four more come within the next 4 seconds. S/Luther appears to be firing
40 gunshots in an eastbound direction. At the 25 second mark, the narrator states, "Nigga is shooting
41 the cops!". S/Luther is seen advancing toward the police units and away from the camera. At the 34
42 second mark, the subject fires two shots. Both can be heard on the video, and a small cloud of light
43 colored smoke passes in front of the second police vehicle parked at the scene.

44
45 The video seems to skip at the 42 second mark. It is only a fraction of a second, but the video
46 noticeably jumps ahead. At the 53 second mark, another gunshot is heard and the narrator states,
47 "He's shooting the cops!", but the camera view of the incident is blocked by passing traffic, including
48 a semi truck and trailer.

49
50 The video again jumps forward at the 1:02 mark. A silver BMW which is passing through the camera
51 view at the time completely disappears. When the video resumes less than a second later, the BMW
52 is nowhere to be seen. This leads me to believe that the video was either edited, or the original
53 camera operator stopped recording, and later resumed recording, interrupting the flow of the
54 incident as it happened.

55
56 At the 1:12 mark, the audio within the video noticeably skips. The narrator is in the middle of saying,
57 "He's shooting bro! I'm seeing a real life shoot out...". His statement is interrupted by the audio skip
58 as he begins to say the word, "real". It is unknown what caused this skip, and the video doesn't
59 appear to be affected by it.

60
61 At the 1:22 mark, the audio and video both seem to pause momentarily. Nothing is being said at the
62 time, but the humming noise of feedback which is present throughout the video is interrupted. The
63 video also seems to get stuck for a brief moment. It is unknown what caused these interruptions.

64
65 At the 1:33 mark, a skip similar to the one mentioned above is present in both audio and video.

66
67 At the 1:43 mark, a skip similar to those mentioned above is present in both audio and video.
68

Date Printed: 10/27/2022 3:19 PM	Case Report Number: 190023109-050	Page: 3 of 4	Ver. 1.3.3
--	---	------------------------	----------------------



Riverside Police Department

Officer Report

File Number:
190023109-050

69 At the 1:50 mark, sirens can be heard approaching the scene. The view of the white truck, the police
70 vehicles, and all subjects is obstructed by a passing tow truck which is towing a black SUV.

71
72 At the 1:53 mark, a skip similar to those mentioned above is present in both audio and video.

73
74 At the 1:56 mark, the video skips ahead. Just prior to the skip, the tow truck mentioned above is in
75 the picture. After the skip, it is no longer in the camera view. Also, the vantage point seems to have
76 changed. The camera now appears to be further away from the white truck, indicating either the
77 vehicle from which the video was filmed was moved backwards, or the person filming the video
78 changed the zoom setting during the time between the audio and video skip.

79
80 At the 2:00 mark, more gunshots can be heard. The person filming the video zooms back in and
81 S/Luther can be seen quickly moving back toward the white truck. He seems to take a position at the
82 front of the truck and is still facing east (toward the marked units). Numerous gunshots are heard
83 being fired between the 2:00 and 2:24 minute marks. In particular, one shot at the 2:23 mark is heard,
84 and S/Luther falls to the ground, directly in front of the white truck. The narrator states, "They shot
85 him, lookit. He's on the floor". S/Luther can still be seen moving, and seems to be in a kneeling
86 position, possibly with at least one hands down in front of him. Additional gunshots can be heard
87 during this time.

88
89 At the 2:29 minute mark, a voice other than the narrator (presumably an officer) states, "Get out of
90 your car!". The narrator says, "Alright", and the video cuts to a solid blue screen at the 2:30 mark. The
91 video resumes at the 2:31 mark with the narrator still inside his car. He points the camera out the
92 front passenger side window. As he does this, a Riverside Police Officer wearing a uniform can be
93 seen holding a patrol rifle. The person filming the incident moves the camera back in the direction of
94 the white truck, and at the 2:35 minute mark, a loud shot can be heard being fired. The person
95 filming pans back to the front passenger window, and at the 2:40 mark, the officer standing outside
96 the car fires a round from his patrol rifle. The sound of this shot and the one preceding it (at the 2:35
97 minute mark) sound similar.

98
99 At the 2:41 second mark, the video and audio seems to pause momentarily. This causes a small skip,
100 but the video seems to resume almost where it had left off. At the 2:44 second mark, the officer
101 broadcasts a callsign which seems to end in "13" followed by the radio traffic "shots fired". After that,
102 the person filming the incident pans back toward the white truck. A group of law enforcement
103 personnel move eastbound along the south sidewalk of Eastridge St. past the car where the person
104 filming is sitting and take cover behind a white vehicle. Additional gunshots are heard, but it is
105 unclear who is firing. The suspect can not be seen in this camera view as the person filming has
106 either zoomed out all the way or has moved the vehicle backwards again.

107
108 At the 3:23 mark, the audio and video noticeably skip. The video resumes in less than a second.

109
110 At the 3:32 mark, the video skips ahead for an unknown amount of time. The video resumes as the
111 person filming zooms in tight on a group of law enforcement personnel who are gathered behind a

Date Printed: 10/27/2022 3:19 PM	Case Report Number: 190023109-050	Page: 4 of 5	Ver. 1.3.3
--	---	------------------------	----------------------



Riverside Police Department

Officer Report

File Number:
190023109-050

112 white vehicle. The audio and video noticeably skip at the 3:42 mark, but resume within less than a
113 second. At the 3:47 mark, the narrator states, "I think he's dead bro, he's laying on the floor already.
114 Man, AR-15 going down with the police going out like a straight OG. Shit crazy."
115

116 At the 4:15 minute mark, the audio and video skip ahead. The person filming seems to be standing at
117 the southeast corner of the intersection of Box Springs Road and Eastridge Ave. A large law
118 enforcement and fire personnel presence is seen as the response to the incident continues.
119

120 At the 4:22 mark, the video cuts back to the shooting. S/Luther can be seen kneeling in front of the
121 white truck. A text bar stating "got shot right know" is present across the top of the screen, which
122 indicates to me that at least this portion of the video was edited. Shots are heard being fired nearby,
123 and then the voice (presumably an officer) is heard stating, "Get out of your car!". This appears to be
124 a second viewing of the footage at 2:29 in the same video. It appears to be from the same camera
125 angle, indicating to me it is likely just a second look at the same footage.
126

127 At the 4:28 mark, the video cuts back to the "Screen Recording" screen, and the red, circular icon is
128 pushed. The video ends as a still shot of [REDACTED] Facebook page is on screen.
129

130 The overall accuracy of this video can not be determined at this time. While footage of the original
131 incident certainly exists, it was posted to an Instagram account after the fact, which would have
132 allowed time for editing. Noticeable skips and edits are present throughout, but it is unknown if clips
133 were taken out of order, or if the video were simply edited for time. As a result, the authenticity of
134 the order of the events depicted in the video is unable to be determined. In addition, a Facebook
135 user by the name of [REDACTED] then screen recorded some of or even all of the footage posted
136 by "Show Off" on his Instagram account. I am unable to determine whether or not he, or anyone else,
137 edited the footage originally posted by "Show Off". The video I watched, reviewed, and submitted as
138 evidence is a recording of a recording, and therefore several variables exist in terms of its true
139 authenticity.
140

141 I booked a copy of the video into evidence at the Magnolia Station.
142

Date Printed: 10/27/2022 3:19 PM	Case Report Number: 190023109-050	Page: 5 of 5	Ver. 1.3.3
-------------------------------------	--------------------------------------	-----------------	---------------



Riverside Police Department

Officer Report

File Number:
190023109-052

Administrative Information

Subject:		1111 - OFFICER NEEDS BACK-UP/URGENT RESPONSE			
Date(s) and Time(s) of Occurrence Or Between:		//			
Location Of Occurrence:		Box Springs Bldg / Eastridge Ave RIVERSIDE			
Date/Time Reported:	8/12/2019 5:38:06 PM	Day:			
Date Of Report:	8/15/2019 11:00:22 AM	Type Of Premises:			
NPC:		RD:	PG08	Beat:	3
Was There a Witness To The Crime?					
Can a Suspect Be Named Or Identified?		By Whom?			
Can a Suspect Vehicle Be Identified?		By Whom?			

Code Section Classification:

Records Section

Reporting Officer:	[REDACTED]				
115 Qualified:	Yes				
Send Copies Of This Report To:					
DOJ/NCIC Entered?		Name/ID			
DOJ/NCIC Cancelled?		Name/ID			
APR Sent?		Name/ID			
APB Sent?		Name/ID			

Public Narrative

Summary of W [REDACTED] statement.

Supervisor Approving

Approving Supervisor:	[REDACTED]
Date Reviewed:	8/15/2019 12:00:00 AM

Witness Information

Code:		Name:	[REDACTED]
[REDACTED]	[REDACTED]	[REDACTED]	[REDACTED]



Riverside Police Department

Officer Report

File Number:
190023109-052

Height:		Weight:	
Hair:		Eyes:	
Notes:			

Witness Addresses:

Address Type	Address	City, State ZIP	County

Witness Phones:

Evidence Information

Physical Evidence Present?		Physical Evidence Seized?	
Photographs Taken?		Photographer?	
Weapon Seized?		Weapon(s) Taken For Safety?	
Gang Related?		Sensitive Data?	
Fingerprint Search Made?		Fingerprints Obtained?	
Narcotics Seized?		Narcotics Field Tested?	
Audio Recording Available?		In Car Recording Available?	
Body Worn Camera Recording Available?			
Type of Weapon, Force, Or Device Used?			
Motive:			

Narrative

- 1 On 8/12/19, I spoke to W/ [REDACTED]. W/ [REDACTED] was the passenger in the tow truck
- 2 dispatched to the are of Sycamore Canyon/Eastridge to assist CHP officers with the towing of the
- 3 suspect's (Aaron Luther) vehicle. W/ [REDACTED] statement was audio recorded and retained in police
- 4 records. The following is a summary of his statement.
- 5
- 6 W/ [REDACTED] told me he worked for Valley Wide Towing. He and his partner W/ [REDACTED] responded to
- 7 the scene and put out the bed of the truck to tow the vehicle as requested by CHP. The officers
- 8 allowed the driver of the vehicle being towed to remove his belongings before it was towed. The tow
- 9 truck drivers were on scene for twenty to twenty-five minutes. There were two officers waiting for the



Riverside Police Department

Officer Report

File Number:
190023109-052

10 tow truck and for the driver to remove his belongings. W/ [REDACTED] was outside of the truck and
11 W/ [REDACTED] was inside of the two truck on the passenger side. W/ [REDACTED] heard gun shots and
12 looked into the rearview mirror. He saw the suspect (driver of the vehicle) on the hood of the truck
13 with his gun out. He saw the suspect was shooting the gun. He saw W/ [REDACTED] run past the tow truck.
14 W/ [REDACTED] told W/ [REDACTED] to run. W/ [REDACTED] jumped to the driver's side of the tow truck. He pushed
15 the air brake in and tried to drive forward. The air bags were down initially. Once they were up he
16 was able to drive. The bed of the tow truck was still out. As he drove he caught up to W/ [REDACTED] and
17 picked him up. He drove to the traffic light and put the bed of the truck up. He could not hear shots
18 from there. He turned left, made a U-turn and came back. He could hear and see the suspect was still
19 shooting. He saw people running and trying to leave. He also tried to leave but was blocked in by
20 other vehicles. He parked the tow truck in a parking lot (2295 Eastridge Ave.) and officers arrived.

21
22 W/ [REDACTED] did not know if any rounds hit the tow truck. He stayed inside the truck because it was his
23 only cover. He drove the tow truck to the light with the bed down. He described the suspect's gun as
24 a bigger gun/rifle. He saw W/ [REDACTED] alert the officers there was something inside the passenger
25 compartment in the center console area of the vehicle of concern. The officer gave W/ [REDACTED] the
26 suspect's key to the truck to see if it would start. W/ [REDACTED] started the truck and saw the gun when
27 he went into the passenger compartment. When W/ [REDACTED] alerted the officer, the suspect was
28 looking right at W/ [REDACTED]. The suspect grabbed the gun from inside the passenger compartment
29 and started shooting.

30
31 W/ [REDACTED] described the suspect as an older male. He was older and grungy. He was wearing shorts,
32 black and white knee socks and had tattoos on his arms and legs. The suspect smoked a cigarette.
33 The tailgate of the suspect's truck was down and he was putting items on the curb when they
34 arrived. There was no issue until he was allowed to get items from the cab. The suspect was taking
35 longer to retrieve items. He brought out an empty bottle and a pad of paper. He put the items down.
36 He smoked his cigarette and looked around. W/ [REDACTED] wondering how long it was going to
37 take because they were there for twenty-five minutes already. The officer had W/ [REDACTED] sign the
38 CHP-180 form. W/ [REDACTED] walked to the cab to put the key in. Afterward, is when everything took
39 place.

40
41 W/ [REDACTED] told me they only knew the location of the vehicle to pick up when they were dispatched.
42 They did not know a description. They drove to the location and saw them waiting there for them.

43
44 The suspect shot toward the officers. He faced the officers when he shot. W/ [REDACTED] ducked down
45 and drove. The suspect continued shooting at the officers. W/ [REDACTED] said the suspect later shot the
46 opposite way toward where we were standing (2295 Eastridge Ave.) W/ [REDACTED] drove to the second
47 light and turned left. He made a U-turn and turned right. He turned right again and found himself in
48 a dead end. He saw people running and pulled into the parking lot and stopped.

49
50 There was one motor officer and an officer in a car. The officers were standing on the curb.
51 [REDACTED] saw the motor officer go to his motorcycle and get a drink of water. The other officer



Riverside Police Department

Officer Report

File Number:
190023109-052

52 stayed on the curb. The motorcycle was directly behind the truck. W/ [REDACTED] did not see anyone get
53 shot. He saw the suspect shooting and assumed the officers were behind vehicles.

54
55 W/ [REDACTED] thought the suspect probably planned to hide the gun inside clothes with the rest of his
56 belongings and hoped nobody knew about it but when he saw the signal from W/ [REDACTED] "all hell
57 broke loose." Once the suspect saw the gesture to the officer, the suspect reached inside the truck
58 and, "Boom, boom, boom." W/ [REDACTED] ran and told W/ [REDACTED] to run. W/ [REDACTED] did not want to get
59 outside of the truck. He moved to the driver's side and drove. He was not hurt. He saw W/ [REDACTED] fall
60 when he was running. W/ [REDACTED] got back up and ran again.

61
62 I asked W/ [REDACTED] if he was injured and he told me he was not injured.

63
64 The interview was concluded.

65
66 Detective [REDACTED] photographed the tow truck and collected a possible bullet fragment from
67 the parking lot of 2295 Eastridge Ave. See his report for further detail.

68
69 Officer [REDACTED] interviewed W/ [REDACTED]. See his report for further detail.
70
71

RIVERSIDE POLICE DEPARTMENT



Riverside Police Department

Officer Report

File Number:
190023109-053

Administrative Information

Subject:		1111 - OFFICER NEEDS BACK-UP/URGENT RESPONSE			
Date(s) and Time(s) of Occurrence Or Between:		//			
Location Of Occurrence:		Box Springs Bldg / Eastridge Ave RIVERSIDE			
Date/Time Reported:	8/12/2019 5:38:06 PM	Day:			
Date Of Report:	8/14/2019 10:34:20 AM	Type Of Premises:			
NPC:		RD:	PG08	Beat:	3
Was There a Witness To The Crime?					
Can a Suspect Be Named Or Identified?		By Whom?			
Can a Suspect Vehicle Be Identified?		By Whom?			

Code Section Classification:

Records Section

Reporting Officer:	[REDACTED]				
115 Qualified:	Yes				
Send Copies Of This Report To:					
DOJ/NCIC Entered?		Name/ID			
DOJ/NCIC Cancelled?		Name/ID			
APR Sent?		Name/ID			
APB Sent?		Name/ID			

Public Narrative

Supervisor Approving

Approving Supervisor:	[REDACTED]				
Date Reviewed:	9/27/2019 12:00:00 AM				

Witness Information

Code:		Name:	[REDACTED]			
[REDACTED]	[REDACTED]	[REDACTED]	[REDACTED]	[REDACTED]	[REDACTED]	



Riverside Police Department

Officer Report

File Number:
190023109-053

[REDACTED]	[REDACTED]	[REDACTED]	[REDACTED]
[REDACTED]	[REDACTED]	[REDACTED]	[REDACTED]

Notes:

Witness Addresses:

Address Type	Address	City, State ZIP	County
[REDACTED]	[REDACTED]	[REDACTED]	[REDACTED]

Witness Phones:

[REDACTED]	[REDACTED]
[REDACTED]	[REDACTED]

Witness Information

Code:	[REDACTED]	Name:	[REDACTED]
[REDACTED]	[REDACTED]	[REDACTED]	[REDACTED]
[REDACTED]	[REDACTED]	[REDACTED]	[REDACTED]
[REDACTED]	[REDACTED]	[REDACTED]	[REDACTED]

Notes:

Witness Addresses:

Address Type	Address	City, State ZIP	County
[REDACTED]	[REDACTED]	[REDACTED]	[REDACTED]

Witness Phones:

[REDACTED]	[REDACTED]
[REDACTED]	[REDACTED]

Witness Information

Code:	[REDACTED]	Name:	[REDACTED]
[REDACTED]	[REDACTED]	[REDACTED]	[REDACTED]
[REDACTED]	[REDACTED]	[REDACTED]	[REDACTED]
[REDACTED]	[REDACTED]	[REDACTED]	[REDACTED]

Witness Addresses:

[REDACTED]	[REDACTED]	[REDACTED]	[REDACTED]
------------	------------	------------	------------



Riverside Police Department

Officer Report

File Number:
190023109-053

Home		
------	--	--

Witness Phones:

Phone Type	Phone Number

Witness Information

Code:		Name:	

Notes:

Witness Addresses:

Address Type	Address	City, State ZIP	County

Witness Phones:

Other Entities

Height:		Weight:	
Hair:		Eyes:	

Notes:

Witness Addresses:

Address Type	Address	City, State ZIP	County



Riverside Police Department

Officer Report

File Number:
190023109-053

Witness Phones:

Phone Type	Phone Number
[REDACTED]	[REDACTED]
Other Entities	
[REDACTED]	[REDACTED]
[REDACTED]	[REDACTED]
[REDACTED]	[REDACTED]
[REDACTED]	[REDACTED]
Height:	Weight:
Hair:	Eyes:
Notes:	

Witness Addresses:

Address Type	Address	City, State ZIP	County
[REDACTED]	[REDACTED]	[REDACTED]	

Witness Phones:

[REDACTED]	[REDACTED]
[REDACTED]	[REDACTED]
Other Entities	
[REDACTED]	[REDACTED]
[REDACTED]	[REDACTED]
[REDACTED]	[REDACTED]
[REDACTED]	[REDACTED]
Height:	Weight:
Hair:	Eyes:
Notes:	

Witness Addresses:

Address Type	Address	City, State ZIP	County
[REDACTED]	[REDACTED]	[REDACTED]	

Witness Phones:

[REDACTED]	[REDACTED]
[REDACTED]	[REDACTED]



Riverside Police Department

Officer Report

File Number:
190023109-053

Other Entities					
[REDACTED]	[REDACTED]	[REDACTED]	[REDACTED]	[REDACTED]	[REDACTED]
[REDACTED]	[REDACTED]	[REDACTED]	[REDACTED]	[REDACTED]	[REDACTED]
[REDACTED]	[REDACTED]	[REDACTED]	[REDACTED]	[REDACTED]	[REDACTED]
Height:	[REDACTED]	Weight:	[REDACTED]	[REDACTED]	[REDACTED]
Hair:	[REDACTED]	Eyes:	[REDACTED]	[REDACTED]	[REDACTED]
Notes:					

Witness Addresses:

Address Type	Address	City, State ZIP	County
[REDACTED]	[REDACTED]	[REDACTED]	[REDACTED]

Witness Phones:

[REDACTED]	[REDACTED]
[REDACTED]	[REDACTED]

Other Entities					
[REDACTED]	[REDACTED]	[REDACTED]	[REDACTED]	[REDACTED]	[REDACTED]
[REDACTED]	[REDACTED]	[REDACTED]	[REDACTED]	[REDACTED]	[REDACTED]
[REDACTED]	[REDACTED]	[REDACTED]	[REDACTED]	[REDACTED]	[REDACTED]
Height:	[REDACTED]	Weight:	[REDACTED]	[REDACTED]	[REDACTED]
Hair:	[REDACTED]	Eyes:	[REDACTED]	[REDACTED]	[REDACTED]
Notes:					

Witness Addresses:

Address Type	Address	City, State ZIP	County
[REDACTED]	[REDACTED]	[REDACTED]	[REDACTED]

Witness Phones:

[REDACTED]	[REDACTED]
[REDACTED]	[REDACTED]
[REDACTED]	[REDACTED]

Other Entities	
Name:	[REDACTED]



Riverside Police Department

Officer Report

File Number:
190023109-053

[REDACTED]	[REDACTED]	[REDACTED]	[REDACTED]
[REDACTED]	[REDACTED]	[REDACTED]	[REDACTED]
Height:	[REDACTED]	Weight:	[REDACTED]
Hair:	[REDACTED]	Eyes:	[REDACTED]
Notes:			

Witness Addresses:

Address Type	Address	City, State ZIP	County
--------------	---------	-----------------	--------

Witness Phones:

Phone Type	Phone Number
[REDACTED]	[REDACTED]

Evidence Information

Physical Evidence Present?	[REDACTED]	Physical Evidence Seized?	[REDACTED]
Photographs Taken?	[REDACTED]	Photographer?	[REDACTED]
Weapon Seized?	[REDACTED]	Weapon(s) Taken For Safety?	[REDACTED]
Gang Related?	[REDACTED]	Sensitive Data?	[REDACTED]
Fingerprint Search Made?	[REDACTED]	Fingerprints Obtained?	[REDACTED]
Narcotics Seized?	[REDACTED]	Narcotics Field Tested?	[REDACTED]
Audio Recording Available?	[REDACTED]	In Car Recording Available?	[REDACTED]
Body Worn Camera Recording Available?	[REDACTED]		[REDACTED]
Type of Weapon, Force, Or Device Used?	[REDACTED]		
Motive:			

Narrative

1 **Investigative Personnel:**

- 2 Sgt. [REDACTED]
- 3 Sgt. [REDACTED]
- 4 Det. [REDACTED] – Case Agent
- 5 Det. [REDACTED] – Co-Case Agent
- 6 Det. [REDACTED] – Riverside University Health System Medical Center
- 7 Det. [REDACTED]
- 8 Det. [REDACTED]
- 9 Det. [REDACTED]



Riverside Police Department

Officer Report

File Number:
190023109-053

10
11
12
13
14
15
16
17
18
19
20
21
22
23
24
25
26
27
28
29
30
31
32
33
34
35
36
37
38
39
40
41
42
43
44
45
46
47
48
49
50
51
52

Forensic Personnel:

Technician [REDACTED]
Technician [REDACTED]
Technician [REDACTED]

Narrative:

On 08-12-19, at about 1815 hours, I learned at least one California Highway Patrol Officer was involved in a shooting in the area of Eastridge Avenue and Box Springs Boulevard. I arrived in the area at around 1950 hours.

I attended a briefing conducted by personnel from Riverside Police Department (R.P.D.), California Highway Patrol (C.H.P.) and Riverside County Sheriff's Department (R.C.S.D). I learned multiple law enforcement Officers/Deputies fired on the suspect who had shot and killed a California Highway Patrol Officer. The suspect was identified as S/Luther, Aaron.

I learned a Riverside Transit Authority bus driver may have witnessed the incident and there may be surveillance video that captured part of the incident.

V [REDACTED]

On 08-12-19, at around 1905 hours, I spoke to W [REDACTED] at Eastridge Avenue and Box Springs Boulevard. I recorded V [REDACTED] statement on my department issued audio recorder. The following is a summary of our conversation and is not verbatim. Please review the recording for greater detail.

V [REDACTED] identified himself a Citizen on Patrol for San Bernardino Sheriff's Department for the City of Highland.

V [REDACTED] told me he was heading west on the Eastridge Avenue bridge. He said an olive-green sports utility vehicle traveling west bound "slammed" on their brakes in front of him. V [REDACTED] slammed on his brakes and got out of his vehicle.

He had opened the back door of his truck. V [REDACTED] said he reached for his Kevlar vest which he possessed as a citizen volunteer. He did not find it.

V [REDACTED] ran from his vehicle and ran north bound towards the off-ramp. A law enforcement Officer directed him to take cover behind a vehicle.

V [REDACTED] said the vehicle in front of him was driven by a female and her vehicle was "hit" by gunfire. V [REDACTED] said his rear window was struck by the shooting.

V [REDACTED] said Officers were deploying behind his vehicle and using it as cover.



Riverside Police Department

Officer Report

File Number:
190023109-053

53 V/ [REDACTED] said he witnessed a C.H.P. Officer or R.S.O. Deputy get “hit in the back” when he was
54 running for cover. V/ [REDACTED] said he saw “dust” come off from the Kevlar vest and Officer “hit
55 the floor”. V/ [REDACTED] said the Officer that was hit near the rear-end of a Charger. The Dodge
56 Charger was the possibly the third vehicle from the suspect’s vehicle. He further described the
57 Charger as being behind the Motor Officer’s motorcycle and a Ford Explorer.

58
59 V/ [REDACTED] said he heard at least 60 or 70 gunshots all together. He described the sound of the
60 shots as “really loud firecrackers” with some shots coming one after the other and other shots
61 were slower with the shooter possibly “looking for a good shot”.

62
63 V/ [REDACTED] said the whole incident from the start of the shooting to the end was around 15 to 17
64 minutes. He said it was “a while”.

65
66 V/ [REDACTED] saw the helicopter land and take off with a “Motor Officer”. V/ [REDACTED] said another
67 injured Officer was taken away in the back of a “Moreno Valley Police vehicle”. He believed the
68 injured Officer taken away by vehicle was a C.H.P. Officer.

69
70 V/ [REDACTED] was directed by a responding law enforcement officer to take cover behind a “unit”
71 (law enforcement vehicle). There was a female taking cover with him. V/ [REDACTED] believed the
72 female may have taken a pictures of the incident. He said the female was “interviewed” by a
73 C.H.P. Officer.

74
75 V/ [REDACTED] indicated he knew there were videos on the internet of the incident.

76
77 V/ [REDACTED] said he did not see the suspect but knew the shooting was coming from the suspect’s
78 truck.

79
80 V/ [REDACTED] identified his vehicle as a 2014 Ford F-150 with “dealer plates”. I later learned
81 V/ [REDACTED] vehicle had a temporary license plate of [REDACTED]. Through a Department of Motor
82 Vehicles check, I learned the vehicle had an assigned license plate of [REDACTED]

83
84 V/ [REDACTED] said he was later escorted down the bridge where he was waiting when I interviewed
85 him.

86
87 V/ [REDACTED] said he took a picture of his vehicle after the shooting was over.



Riverside Police Department Officer Report

File Number:
190023109-053



88
89 V/ [REDACTED] provided me with the above picture that he took. The picture shows V/ [REDACTED]
90 vehicle with both side doors open. The damage of the window to the rear door is visible. I later
91 saved this picture to the case.
92
93 V/ [REDACTED] said he was not injured.

Date Printed: 10/30/2022 11:13	Case Report Number: 190023109-053	Page: 9 of 10	Ver. 1.3.3
--	---	-------------------------	----------------------



Riverside Police Department

Officer Report

File Number:
190023109-053

94
95 I contacted V [REDACTED] on 08-13-19 and asked for permission to search his vehicle. He consented
96 to a search of his vehicle for evidence. Assisting personnel searched of V [REDACTED] vehicle for
97 evidence. See related reports for further.

98 On 08-15-19, at 1718 hours, I released V [REDACTED] vehicle to him at Magnolia Police Station. I
99 asked him follow-up questions which I recorded on my department issued audio recorder.

100
101 V [REDACTED] told me he immediately tried to get his vest after exiting his vehicle. He left both
102 driver's side doors open. His driver's side window was down. The rear window was open (the
103 window that was broken). V [REDACTED] said his vehicle's window was broken while he was out of
104 his vehicle and behind the cover of another vehicle. (I could see damage to the window frame of
105 the driver's door of V [REDACTED] vehicle consistent with a bullet strike).

106
107 O [REDACTED]
108 On 08-12-19, at around 2125 hours, I spoke to Cal-Fire Department firefighter O [REDACTED]
109 O [REDACTED] identified himself as Moreno Valley Fire Battalion Chief. O [REDACTED] office is at
110 Station 99. I recorded O [REDACTED] statement on my department issued audio recorder. The
111 following is a summary of our conversation and is not verbatim. Please review the recording for
112 greater detail.

113
114 O [REDACTED] said he is also a Fire Investigator. O [REDACTED] told me responded to the call. O [REDACTED]
115 said fire department personnel staged until the scene was cleared. He believed Engine 6 drove
116 into the scene at 1756 and O [REDACTED] arrived on scene at 1757. O [REDACTED] believed Riverside Fire
117 Department personnel arrived at around the same time.

118
119 O [REDACTED] learned the injured Officers had been transported already. O [REDACTED] said the
120 suspect/patient was breathing and had a pulse and medical personnel provided "life saving
121 measures". He identified the medic who provided medical care to the S/Luther as O [REDACTED]

122
123 O [REDACTED]
124 On 08-12-19, at around 2138 hours, I spoke to Cal-Fire Department Paramedic O [REDACTED]
125 [REDACTED] I recorded O [REDACTED] statement on my department issued audio recorder. The
126 following is a summary of our conversation and is not verbatim. Please review the recording for
127 greater detail.

128
129 O [REDACTED] said they were staged in front of a public school near Edgemont Street (likely
130 Edgemont Elementary School). They responded from Edgemont Elementary and arrived in the
131 scene.

132
133 O [REDACTED] said they found the patient in front of his vehicle. O [REDACTED] said he did not find
134 a heartbeat. They started chest compressions and provided other life saving measures.

135 O [REDACTED] said some people on scene did feel a pulse. O [REDACTED] said S/Luther was
136 transported to the hospital. O [REDACTED] said CPR was performed for 34 to 35 minutes.

Date Printed: 10/30/2022 11:13	Case Report Number: 190023109-053	Page: 10 of 11	Ver. 1.3.3
--	---	--------------------------	----------------------



Riverside Police Department

Officer Report

File Number:
190023109-053

137
138 O [REDACTED] said he had been a Paramedic for about two years. O [REDACTED] was previously an
139 Emergency Medic Technician (EMT) for American Medical Response (AMR) for about five
140 years.

141 [REDACTED]
142 [REDACTED]
143 I learned Riverside Police Dispatch had received a message from a person who identified
144 themselves as [REDACTED] who may have video recorded the shooting. I called the phone number
145 provided for [REDACTED] 3. I did not receive a return call.

146
147 W [REDACTED]
148 On 08-13-19, at about 0948 hours, I was approached by a W [REDACTED] while I was near the
149 crime scene. W [REDACTED] located at 2220 Eastridge Avenue,
150 suite Q. I recorded W [REDACTED] statement on my department issued audio recorder. The following
151 is a summary of our conversation and is not verbatim. Please review the recording for greater
152 detail.

153
154 W [REDACTED] told me he had left worked and headed eastbound on Eastridge Avenue at around 1700
155 hours. He was waiting behind a line of vehicles stopped at the intersection. W [REDACTED] was in the
156 left turn lane waiting to merge onto the 215 Freeway. W [REDACTED] was stopped even with the
157 suspect's truck. W [REDACTED] could see the single occupant of the truck sitting in the driver's seat.
158 W [REDACTED] saw the two Officers standing behind the vehicle. He described the driver as a male
159 with dark hair but could not describe the driver any further. W [REDACTED] said the driver was the only
160 occupant of the vehicle. W [REDACTED] described the suspect's vehicle as a white mini-truck with an
161 "off-color" camper shell.

162
163 W [REDACTED] saw the two C.H.P. Officers standing together between the motorcycle and a police
164 unit. [REDACTED] believed the Officers were talking. The motorcycle Officer had his "book" out.
165 W [REDACTED] demonstrated one Officer was facing towards W [REDACTED] and the other Officer was
166 facing toward the (suspect's) truck. W [REDACTED] waited a minute or two in the line before he
167 continued on.

168
169 W [REDACTED] said the driver was sitting still and looking forward. W [REDACTED] did not see any other law
170 enforcement officers or a tow truck.

171
172 W [REDACTED] said his boss had left after him and had seen the suspect with a rifle in a bag. W [REDACTED]
173 said his boss had provided a statement to law enforcement about what she observed.

174
175 W [REDACTED]
176 On 08-13-19, I learned W [REDACTED] had contacted Riverside Police Department Dispatch and
177 wanted to make a report reference this investigation. At about 1022 hours, I called and spoke to
178 W [REDACTED] I recorded W [REDACTED] statement on my department issued audio recorder. The

Date Printed: 10/30/2022 11:13	Case Report Number: 190023109-053	Page: 11 of 12	Ver. 1.3.3
-----------------------------------	--------------------------------------	-------------------	---------------



Riverside Police Department

Officer Report

File Number:
190023109-053

179 following is a summary of our conversation and is not verbatim. Please review the recording for
180 greater detail.

181
182 W [REDACTED] told me she was taking the ramp towards the freeway at around 1730 hours. W [REDACTED]
183 had left work heading east towards the freeway. She saw people running around getting on a tow
184 truck and the tow truck "rushed out". W [REDACTED] saw two people on the tow truck. W [REDACTED]
185 stopped her vehicle on the side of the ramp towards the north bound 215 Freeway. She did not
186 see any other cars near her.

187
188 W [REDACTED] said the tow truck went forward and "kinda stopped" and the car fell off the tow truck.
189 W [REDACTED] thought the car was initially attached to the tow truck and was possibly drug a couple
190 of feet before it was freed from the tow truck. The tow truck left the area.

191
192 W [REDACTED] saw and heard shooting. W [REDACTED] said the shooter was firing towards a cop and the
193 cop fired back. The shooter was hiding to the front and right side of a vehicle. The shooter was
194 firing east bound. She could not remember what kind of vehicle the shooter was behind.
195 W [REDACTED] thought the shooter had a handgun. W [REDACTED] said the shooter was looking around
196 and she got out of the area.

197
198 W [REDACTED] described the shooter as a "husky" white male wearing baggy clothes. She was unable
199 to describe him any further. W [REDACTED] said she was hiding in her car and the incident happened
200 "fast".

201
202 W [REDACTED] saw one police officer who was firing back. W [REDACTED] said she heard more than ten
203 shots. W [REDACTED] said she felt afraid. W [REDACTED] was afraid he might come towards her after the
204 shooter began to look around. W [REDACTED] said the shooter was looking around and kept looking
205 behind him. That was when W [REDACTED] believed the shooter saw her.

206
207 W [REDACTED] said she was there for around two minutes. She made a U-turn and fled back towards
208 her workplace. W [REDACTED] described her car as a white Toyota Camry.

209
210 W [REDACTED] did not take any video recording or pictures. W [REDACTED] was by herself.

211
212 **Crime Scene:**
213 I assisted in the crime scene and searched for evidence on 08-12-19 and 08-13-19. I also assisted
214 in searching for surveillance video of the incident.

215
216 I looked for surveillance video that may have captured the incident. I spoke to [REDACTED] who
217 [REDACTED]
218 [REDACTED] is a building located on the north-east corner of Eastridge Avenue and Box Springs
219 Boulevard. I viewed a display showing the video surveillance camera views. I noted that none of
220 the camera angles I viewed recorded the areas where the shooting occurred.

221

Date Printed: 10/30/2022 11:13	Case Report Number: 190023109-053	Page: 12 of 13	Ver. 1.3.3
-----------------------------------	--------------------------------------	-------------------	---------------



Riverside Police Department

Officer Report

File Number:
190023109-053

222 At 0835 hours, I asked [REDACTED] if we could collect the DVR. [REDACTED] consented to us to taking the
223 DVR containing video surveillance in order to download and preserve any video recording that
224 may show the incident. Detective [REDACTED] assisted by further reviewing the surveillance video
225 on the DVR. I learned from Detective [REDACTED] that the videos did not show any activity related to
226 our investigation. Detective [REDACTED] and Technician [REDACTED] assisted by documenting
227 and searching for evidence at building. Please see their reports for further.

228
229 I contacted Transportation Manager [REDACTED] in the City of
230 Riverside. This location is a business name [REDACTED]. I asked to view video
231 surveillance at the business. I viewed the video surveillance display and noted that none of the
232 surveillance cameras showed the areas where the incident occurred.

Officer K. Feimer's Rifle:

233
234
235 On 08-13-19, at 1222 hours, I assisted Technician [REDACTED] with examining and collecting
236 Officer K. Feimer's rifle. We collected the rifle in unit 3849. See [REDACTED] report for
237 further.

Officer K. Feimer's Police Unit 3849:

238
239
240 On 08-13-19, at about 1315 hours, I brought Riverside Police Department IT Technician
241 [REDACTED] to Officer K. Feimer's vehicle. [REDACTED] removed a hard-drive containing the
242 recording from the vehicle's camera to download and preserve the video.

243
244 W/ [REDACTED]

245 On 08-13-19 at around 2330 hours, I released W/ [REDACTED] vehicle to him. W/ [REDACTED] took
246 possession of his vehicle from Eastridge Avenue and Box Spring Boulevard.

Riverside Transit Authority Video:

247
248
249 I learned from assisting investigators that a Riverside Transit Authority bus may have recorded
250 portions of the shooting. I later reviewed Officer [REDACTED] report. I learned W/ [REDACTED]
251 [REDACTED] was the driver of bus [REDACTED] and observed the suspect firing a rifle at a CHP
252 Officer. His vehicle was equipped with video surveillance.

253
254 On 08-13-19, at about 1434 hours, I responded to 1825 Third Street which is an administration
255 office for the Riverside Transit Authority (RTA). I met with Chief Operating Officer [REDACTED]
256 [REDACTED] provided me with a video recorded by cameras on RTA bus [REDACTED] on 08-12-
257 19. He believed the date and time shown on the surveillance video was accurate but had not
258 verified that when he created the recording. I later placed the recording into evidence for
259 preservation.

California Highway Patrol Vehicle Camera Videos:

260
261
262 On 08-14-19, California Highway Patrol Critical Incident Investigation Team (CIIT) Officer
263 [REDACTED] responded to Magnolia Station. He provided me with an initial certified copies of
264 Officer [REDACTED] Officer [REDACTED] Officer [REDACTED] and Officer [REDACTED] These



Riverside Police Department

Officer Report

File Number:
190023109-053

265 copies did not include a running time and date stamp. I placed five compact disks with vehicle
266 camera recordings for C.H.P. Officers [REDACTED] into
267 evidence for preservation. I requested a copy that showed the date and time.

268
269 On 08-14-19, Officer [REDACTED] provided another set of videos that included a time and date
270 stamp.

271
272 O [REDACTED]
273 On 08-14-19, at about 1103 hours, I called and spoke to O [REDACTED] O [REDACTED] had called my desk
274 phone asking to provide information about this case. I recorded O [REDACTED] statement on my
275 department issued audio recorder. The following is a summary of our conversation and is not
276 verbatim. Please review the recording for greater detail.

277
278 O [REDACTED] told me he was driving on University Avenue in the City of Riverside. He said a white
279 GMC truck with a gray "cab" (likely a camper shell) on the back sped by him on University
280 Avenue at an unknown cross street. O [REDACTED] could not see the occupants of the vehicle. O [REDACTED]
281 swerved out of the way and the vehicle continued on. He believed it was the same truck (from
282 the incident).

283
284 O [REDACTED] said he was driving home when he saw a C.H.P. Officer on the 60 freeway heading
285 towards the 215 Freeway. He said that occurred right before the incident.

286
287 W [REDACTED]
288 On 08-16-19, at about 0915 hours, Officer [REDACTED] provided me with a compact disk with a
289 video recording taken by W/ [REDACTED]

290
291 I called W/ [REDACTED] in an attempt to speak to him at 1030 hours. My call was not
292 answered and I his voice mailbox was full. I placed a compact disk containing the video into
293 evidence for preservation.

294
295 W/ [REDACTED]
296 On 08-16-19, at about 1036 hours, I spoke to W [REDACTED] on the phone [REDACTED] I
297 recorded W/ [REDACTED] statement on my department issued audio recorder. The following is
298 a summary of our conversation and is not verbatim. Please review the recording for greater
299 detail.

300
301 W [REDACTED] said she exited Eucalyptus from the north bound 215 Freeway. She said she
302 was behind several other vehicles when she heard shooting. She could see police with firearms
303 but could not see who they were shooting at. W/ [REDACTED] hid behind a car during the
304 shooting. She saw a man shooting beside a white car. She later learned that was a Police
305 Officer's car.

306



Riverside Police Department

Officer Report

File Number:
190023109-053

307 W/ [REDACTED] said she took video towards the end of the incident. She told me she would
308 send the videos to me. I provided W/ [REDACTED] with my email address and she said she
309 would send me the videos. I had not received the videos by the time of this report.

310
311 W/ [REDACTED] said it was "so traumatic". W/ [REDACTED] said she was with another
312 female who was "hysterical". She told me she was going to try and contact that female in the
313 future. W/ [REDACTED] said the female was driving an Expedition.

314
315 Afterwards, she came out and was told to leave. W/ [REDACTED] indicated she did not make a
316 report to any law enforcement on scene.

317
318 W/ [REDACTED] described her vehicle a white Lexus RX350. W/ [REDACTED] described
319 seeing a male video recording or taking pictures of the incident. She said the male was driving a
320 blue hatchback Mazda or similar vehicle.

321
322 W/ [REDACTED] said she was not injured and her vehicle was not damaged. W/ [REDACTED]
323 said her vehicle is visible in footage she saw on the news.

324
325 W/ [REDACTED] said she has had problems sleeping since the incident and described herself as
326 a "wreck" since the incident.

327
328 W/ [REDACTED] and I spoke about how she could go to the Riverside University Health
329 System (RUHS) for counseling. She told me she had a phone number for someone to contact at
330 RUHS.

331
332 **Volunteer [REDACTED] Report:**
333 I received a report prepared by Volunteer [REDACTED] detailing his search and recovery of
334 C.H.P. Officer Moye's helmet badge/shield. I scanned the report and included it with the case.

335
336 **Interviews of Riverside Police Officer Feimer, C.H.P. Officer [REDACTED] and Officer [REDACTED]:**
337 I assisted Detective [REDACTED] with the interviews of Riverside Police Officer Feimer, C.H.P.
338 Officer [REDACTED] and Officer [REDACTED]. Afterwards, I placed the pictures shown to these Officers
339 into evidence for preservation. See Detective [REDACTED] reports for further.

340



Riverside Police Department

Officer Report

File Number:
190023109-054

Administrative Information

Subject:	187 PC				
Date(s) and Time(s) of Occurrence Or Between:	//				
Location Of Occurrence:	Box Springs Blvd / Eastridge Ave RIVERSIDE				
Date/Time Reported:	8/12/2019 5:38:06 PM	Day:			
Date Of Report:	8/15/2019 8:08:42 PM	Type Of Premises:			
NPC:		RD:	PG08	Beat:	3
Was There a Witness To The Crime?					
Can a Suspect Be Named Or Identified?		By Whom?			
Can a Suspect Vehicle Be Identified?		By Whom?			

Code Section Classification:

Offense	Code Section
MURDER:FIRST DEGREE	187(A)
Completed	Yes

Records Section

Reporting Officer:	[REDACTED]		
115 Qualified:	Yes		
Send Copies Of This Report To:			
DOJ/NCIC Entered?		Name/ID	
DOJ/NCIC Cancelled?		Name/ID	
APR Sent?		Name/ID	
APB Sent?		Name/ID	

Public Narrative

I responded to Box Springs and Eastridge to assist with an officer involved shooting that resulted in an on-duty law enforcement officer's death.

Supervisor Approving

Approving Supervisor:	[REDACTED]
Date Reviewed:	8/15/2019 12:00:00 AM



Riverside Police Department

Officer Report

File Number:
190023109-054

Evidence Information

Physical Evidence Present?		Physical Evidence Seized?	
Photographs Taken?		Photographer?	
Weapon Seized?		Weapon(s) Taken For Safety?	
Gang Related?		Sensitive Data?	
Fingerprint Search Made?		Fingerprints Obtained?	
Narcotics Seized?		Narcotics Field Tested?	
Audio Recording Available?		In Car Recording Available?	
Body Worn Camera Recording Available?			
Type of Weapon, Force, Or Device Used?			
Motive:			

Narrative

1 On 8-12-2019 I was on-duty for the Riverside Police Department as a uniformed Patrol Supervisor. I
2 was in the area of Van Buren and Lincoln when I heard Dispatch announce an emergency broadcast
3 stating that a CHP officer was being shot at by an armed suspect with an assault rifle in the area of
4 Eastridge and Box Springs Blvd.
5
6 I drove Code-3 and entered the eastbound SR-91 FWY at Adams St. to the eastbound 60FWY and
7 exited Fair Isle/Box Springs. While driving I heard radio traffic that the suspect had been shot and
8 that Air-1 landed and extracted one of the downed officers. I arrived at Box Springs/Eastridge and
9 saw Sergeant [REDACTED] and Lieutenant [REDACTED] just ahead of me and we all walked and entered the
10 already established crime scene. After speaking with them briefly we agreed that I would assume
11 crime scene management at the top of the overpass and Sergeant [REDACTED] management closest to
12 the Box Springs/Eastridge intersection.
13
14 I acted as an RPD liaison and had immediate and constant contact with CHP Sergeant [REDACTED]
15 [REDACTED], RSO Sergeant [REDACTED], RSO Sergeant [REDACTED]
16 [REDACTED] a Cal Fire Battalion Chief and an AMR supervisor. During my conversations with the allied
17 agency officers I ensured the scene was rendered safe and that a crime scene log had been
18 established by RPD. I also learned there were crime scene logs already in place by CHP and RSO.
19 I had Officer [REDACTED] restrict access on the north side of the overpass as evidence existed there. As time
20 progressed I relieved Officer [REDACTED] from that task and reassigned Officer [REDACTED] I assigned Officer
21 [REDACTED] to assume his role as a RPOA representative and assist Officer K. Feimer and take him to the
22 Magnolia Station.



Riverside Police Department

Officer Report

File Number:
190023109-054

23
24 I assigned Officer [REDACTED] to maintain visual security of the suspect's weapon along with an RSO
25 deputy that was already on scene doing the same. I had Officer [REDACTED] and Detective [REDACTED]
26 contact and obtain statements from victims/witnesses in vehicles on the southbound onramp from
27 Eastridge.

28
29 I was given the keys to two CHP Charger vehicles that were inside the crime scene and I delivered
30 them Lieutenant [REDACTED]. I ensured that none of the allied agency officers departed the crime scene
31 with any evidence and that all public safety vehicles present when we arrived, also remained within
32 the taped off area.

33
34 I remained at the scene in this capacity until I was relieved per Lieutenant [REDACTED] and Lieutenant
35 [REDACTED]
36

RIVERSIDE POLICE DEPARTMENT

Date Printed: 10/30/2022 11:18	Case Report Number: 190023109-054	Page: 3 of 3	Ver. 1.3.3
-----------------------------------	--------------------------------------	-----------------	---------------



Riverside Police Department

Officer Report

File Number:
190023109-055

Administrative Information

Subject:	1111 - OFFICER NEEDS BACK-UP/URGENT RESPONSE				
Date(s) and Time(s) of Occurrence Or Between:	//				
Location Of Occurrence:	Box Springs Bldg / Eastridge Ave RIVERSIDE				
Date/Time Reported:	8/12/2019 5:38:06 PM	Day:			
Date Of Report:	8/15/2019 8:32:24 PM	Type Of Premises:			
NPC:		RD:	PG08	Beat:	3
Was There a Witness To The Crime?					
Can a Suspect Be Named Or Identified?			By Whom?		
Can a Suspect Vehicle Be Identified?			By Whom?		

Code Section Classification:

Records Section

Reporting Officer:	[REDACTED]		
115 Qualified:	Yes		
Send Copies Of This Report To:			
DOJ/NCIC Entered?		Name/ID	
DOJ/NCIC Cancelled?		Name/ID	
APR Sent?		Name/ID	
APB Sent?		Name/ID	

Public Narrative

Supervisor Approving

Approving Supervisor:	[REDACTED]
Date Reviewed:	8/16/2019 12:00:00 AM

Evidence Information

Physical Evidence Present?		Physical Evidence Seized?	
----------------------------	--	---------------------------	--



Riverside Police Department

Officer Report

File Number:
190023109-055

Photographs Taken?		Photographer?	
Weapon Seized?		Weapon(s) Taken For Safety?	
Gang Related?		Sensitive Data?	
Fingerprint Search Made?		Fingerprints Obtained?	
Narcotics Seized?		Narcotics Field Tested?	
Audio Recording Available?		In Car Recording Available?	
Body Worn Camera Recording Available?			
Type of Weapon, Force, Or Device Used?			
Motive:			

Narrative

- 1 NARRATIVE:
- 2 On 08-12-19, at approximately 1945 hours, I was called into work by Sergeant [REDACTED] to assist in a
- 3 homicide investigation. I responded to RPD Magnolia Station where I assisted in my capacity as a
- 4 Gang Intelligence Unit detective.
- 5 At approximately 2330 hours, I responded to the RPD Aviation Hangar to collect Officer [REDACTED]
- 6 clothing. Ultimately, I collected Officer [REDACTED] uniform shirt, pants, and gloves. Dried blood was
- 7 observed on each item and they were placed in their own respective paper bags. While at the
- 8 Hangar, I also collected a USB flash drive from RPD helicopter N911RP which I photographed prior to
- 9 Officer [REDACTED] removing and providing the flash drive to me.
- 10 All items were collected and booked by me into evidence at RPD Magnolia Station.
- 11 After the items were booked, I responded to the crime scene at approximately 0200 hours. On scene,
- 12 I maintained scene security until approximately 0700 hours, when I was relieved by RPD Robbery-
- 13 Homicide detectives.
- 14



Riverside Police Department

Officer Report

File Number:
190023109-056

Administrative Information

Subject:	1111 - OFFICER NEEDS BACK-UP/URGENT RESPONSE				
Date(s) and Time(s) of Occurrence Or Between:	//				
Location Of Occurrence:	Box Springs Bldg / Eastridge Ave RIVERSIDE				
Date/Time Reported:	8/12/2019 5:38:06 PM	Day:			
Date Of Report:	8/17/2019 12:15:04 AM	Type Of Premises:			
NPC:		RD:	PG08	Beat:	3
Was There a Witness To The Crime?					
Can a Suspect Be Named Or Identified?		By Whom?			
Can a Suspect Vehicle Be Identified?		By Whom?			

Code Section Classification:

Records Section

Reporting Officer:	[REDACTED]		
115 Qualified:	Yes		
Send Copies Of This Report To:			
DOJ/NCIC Entered?		Name/ID	
DOJ/NCIC Cancelled?		Name/ID	
APR Sent?		Name/ID	
APB Sent?		Name/ID	

Public Narrative

I responded to the scene and relieved Sgt. [REDACTED]

Supervisor Approving

Approving Supervisor:	[REDACTED]
Date Reviewed:	8/17/2019 12:00:00 AM

Evidence Information

Physical Evidence Present?		Physical Evidence Seized?	
----------------------------	--	---------------------------	--



Riverside Police Department

Officer Report

File Number:
190023109-056

Photographs Taken?		Photographer?	
Weapon Seized?		Weapon(s) Taken For Safety?	
Gang Related?		Sensitive Data?	
Fingerprint Search Made?		Fingerprints Obtained?	
Narcotics Seized?		Narcotics Field Tested?	
Audio Recording Available?		In Car Recording Available?	
Body Worn Camera Recording Available?			
Type of Weapon, Force, Or Device Used?			
Motive:			

Narrative

- 1 On 8-13-19 at approx. 0200hrs I responded to the scene and relieved Sergeant [REDACTED] as the on
- 2 Scene Supervisor. I maintained on scene supervision over night until I was relieved by Sergeant
- 3 [REDACTED] at approx. 0800 hrs. There was no notable incidents to report over night.
- 4



Riverside Police Department

Officer Report

File Number:
190023109-057

Administrative Information

Subject:	1111 - OFFICER NEEDS BACK-UP/URGENT RESPONSE				
Date(s) and Time(s) of Occurrence Or Between:	//				
Location Of Occurrence:	Box Springs Bldg / Eastridge Ave RIVERSIDE				
Date/Time Reported:	8/12/2019 5:38:06 PM	Day:			
Date Of Report:	8/18/2019 9:03:07 PM	Type Of Premises:			
NPC:		RD:	PG08	Beat:	3
Was There a Witness To The Crime?					
Can a Suspect Be Named Or Identified?			By Whom?		
Can a Suspect Vehicle Be Identified?			By Whom?		

Code Section Classification:

Records Section

Reporting Officer:	[REDACTED]		
115 Qualified:	Yes		
Send Copies Of This Report To:			
DOJ/NCIC Entered?		Name/ID	
DOJ/NCIC Cancelled?		Name/ID	
APR Sent?		Name/ID	
APB Sent?		Name/ID	

Public Narrative

Assisted with scene security.

Supervisor Approving

Approving Supervisor:	[REDACTED]
Date Reviewed:	8/19/2019 12:00:00 AM

Evidence Information

Physical Evidence Present?		Physical Evidence Seized?	
----------------------------	--	---------------------------	--



Riverside Police Department

Officer Report

File Number:
190023109-057

Photographs Taken?		Photographer?	
Weapon Seized?		Weapon(s) Taken For Safety?	
Gang Related?		Sensitive Data?	
Fingerprint Search Made?		Fingerprints Obtained?	
Narcotics Seized?		Narcotics Field Tested?	
Audio Recording Available?		In Car Recording Available?	
Body Worn Camera Recording Available?			
Type of Weapon, Force, Or Device Used?			
Motive:			

Narrative

1 On 08/13/19, at approximately 0730 hours, I was contacted at home by Sgt. [REDACTED] and asked if I
 2 could assist with scene security for the OIS.
 3
 4 I responded to the Lincoln Station where I changed into uniform and got a marked police unit. I
 5 drove to Sycamore Canyon and Eastridge to relieve Sgt. [REDACTED]; I arrived at approximately
 6 0900 hours. During my shift, I supervised officers and/or provided security at the following locations:
 7
 8 Sycamore Canyon / Eastridge
 9 Box Springs / Eastridge (north side)
 10 Box Springs / Eastridge (south side)
 11 Eastridge on ramp (south bound)
 12 Eastridge / Old 215
 13
 14 I co-ordinated relief for the officers with Lt. [REDACTED] (Watch C) and Lt. [REDACTED] (Watch A). The
 15 officers included:
 16

[REDACTED]



Riverside Police Department Officer Report

File Number:
190023109-057

[REDACTED]

38
39 Once the scene was clear of all evidence, I stood by for TSU to clean the scene. At approximately
40 0700 hours (08/14/19), I contacted Lt. [REDACTED] and advised there was an issue with TSU's equipment.
41 During that call, I was advised to clear.
42
43 Nothing further.
44
45
46
47
48

RIVERSIDE POLICE DEPARTMENT



Riverside Police Department

Officer Report

File Number:
190023109-058

Administrative Information

Subject:		1111 - OFFICER NEEDS BACK-UP/URGENT RESPONSE		
Date(s) and Time(s) of Occurrence Or Between:		//		
Location Of Occurrence:		Box Springs Bldg / Eastridge Ave RIVERSIDE		
Date/Time Reported:	8/12/2019 5:38:06 PM	Day:		
Date Of Report:	8/18/2019 9:41:37 PM	Type Of Premises:		
NPC:		RD:	PG08	Beat: 3
Was There a Witness To The Crime?				
Can a Suspect Be Named Or Identified?		By Whom?		
Can a Suspect Vehicle Be Identified?		By Whom?		

Code Section Classification:

Offense	Code Section
MURDER:SECOND DEGREE	187(A)
Completed	Yes

Records Section

Reporting Officer:	[REDACTED]		
115 Qualified:	Yes		
Send Copies Of This Report To:			
DOJ/NCIC Entered?		Name/ID	
DOJ/NCIC Cancelled?		Name/ID	
APR Sent?		Name/ID	
APB Sent?		Name/ID	

Public Narrative

--	--	--	--

Supervisor Approving

Approving Supervisor:	[REDACTED]		
Date Reviewed:	8/20/2019 12:00:00 AM		



Riverside Police Department

Officer Report

File Number:
190023109-058

Evidence Information

Physical Evidence Present?		Physical Evidence Seized?	
Photographs Taken?		Photographer?	
Weapon Seized?		Weapon(s) Taken For Safety?	
Gang Related?		Sensitive Data?	
Fingerprint Search Made?		Fingerprints Obtained?	
Narcotics Seized?		Narcotics Field Tested?	
Audio Recording Available?		In Car Recording Available?	
Body Worn Camera Recording Available?			
Type of Weapon, Force, Or Device Used?			
Motive:			

Narrative

1 **Source of Activity:**

2 On Monday, August 12, 2019, at approximately 1738 hours, I was working in full uniform, driving a
3 clearly marked Black and White police vehicle, assigned to patrol as S-70 for the Riverside Police
4 Department. While on duty, Riverside Police Dispatch advised CHP was requesting help in the area
5 of Eastridge Ave. and Box Springs. Dispatched further advised shots were being fired and officers
6 were down.

7
8 **Observations:**

9 Upon arrival at the intersection of Eastridge / Box Springs, I noticed multiple agencies on-scene and
10 a perimeter was established with the use of crime scene tape which contained the entire intersection.
11 The agencies that I observed on-scene were from Riverside Police department, Riverside Sheriff
12 Department and California Highway Patrol.

13
14 I went directly to the area of where the traffic stop was conducted believing that was the only scene /
15 area that had to be secured. Once there, I observed Riverside Fire personnel providing medical aid
16 to the suspect. I learned that the injured CHP officers had already been transported by means of the
17 Riverside Police Departments Air Unit and a patrol unit to Riverside University Health System Medical
18 Center (RUHSMC) located in the city of Moreno Valley.

19
20 I then located Officer Kevin Feimer back at the intersection of Eastridge / Box Springs and checked
21 on his conduction. I asked Officer K. Feimer the public safety questions. Officer K. Feimer advised
22 he fired three shots in a E/B direction towards the suspect. I asked what weapon he utilized and he



Riverside Police Department

Officer Report

File Number:
190023109-058

23 advised his AR-15. I asked him where the weapon was located and he told me it was secured inside
24 his patrol unit (3849). The weapon was left secured inside that patrol unit.

25
26 Officer [REDACTED] was requested to stand by with Officer K. Feimer as peer support throughout the rest of
27 the investigation. Officer [REDACTED] was then instructed to transport Officer K. Feimer to the Magnolia
28 Police Station. I was contacted by Sergeant [REDACTED] and advised to download Officer K. Feimer's body
29 worn camera. Due to me being at the scene, I contacted Sergeant [REDACTED] and asked him to contact
30 Officer Feimer at the Magnolia Police Station and download Officer Feimer's body worn camera.

31
32 During the incident, I assigned Officer [REDACTED] to respond to RUHS in order to be a liaison and
33 provide me updated information from RSO or CHP personnel.

34
35 At this point I noticed additional personnel were arriving from from different agencies and I began
36 assigning officer to containment, crime scene log, canvassing the area, scene security and maintaining
37 the scene.

38
39 Later in the investigation, Riverside Police Departments Robbery/Homicide Detectives arrived and
40 assumed the investigation. During the investigation, I provided a brief to all investigating personnel
41 involving CHP, RSO, RPD and the DA's office.

42
43 Once Graveyard personnel became available I was relieved by Sergeant [REDACTED]
44

RIVERSIDE POLICE DEPARTMENT

Date Printed: 10/30/2022 11:23	Case Report Number: 190023109-058	Page: 3 of 3	Ver. 1.3.3
--	---	------------------------	----------------------



Riverside Police Department

Officer Report

File Number:
190023109-060

Administrative Information

Subject:		1111 - OFFICER NEEDS BACK-UP/URGENT RESPONSE			
Date(s) and Time(s) of Occurrence Or Between:		//			
Location Of Occurrence:		Box Springs Bldg / Eastridge Ave RIVERSIDE			
Date/Time Reported:	8/12/2019 5:38:06 PM	Day:			
Date Of Report:	8/19/2019 3:50:49 PM	Type Of Premises:			
NPC:		RD:	PG08	Beat:	3
Was There a Witness To The Crime?					
Can a Suspect Be Named Or Identified?		By Whom?			
Can a Suspect Vehicle Be Identified?		By Whom?			

Code Section Classification:

Records Section

Reporting Officer:	[REDACTED]				
115 Qualified:	Yes				
Send Copies Of This Report To:					
DOJ/NCIC Entered?		Name/ID			
DOJ/NCIC Cancelled?		Name/ID			
APR Sent?		Name/ID			
APB Sent?		Name/ID			

Public Narrative

Supervisor Approving

Approving Supervisor:	[REDACTED]				
Date Reviewed:	8/20/2019 12:00:00 AM				

Evidence Information

Physical Evidence Present?		Physical Evidence Seized?	
----------------------------	--	---------------------------	--



Riverside Police Department

Officer Report

File Number:
190023109-060

Photographs Taken?		Photographer?	
Weapon Seized?		Weapon(s) Taken For Safety?	
Gang Related?		Sensitive Data?	
Fingerprint Search Made?		Fingerprints Obtained?	
Narcotics Seized?		Narcotics Field Tested?	
Audio Recording Available?		In Car Recording Available?	
Body Worn Camera Recording Available?			
Type of Weapon, Force, Or Device Used?			
Motive:			

Narrative

1 **Evidence Processed:**

- 2
- 3 1. Coolpad cell phone, Model: Unknown, IMEI: 860667041159158
- 4 2. SanDisk 32 GB Micro SD memory card removed from Item #1
- 5

6 **Source:**

7

8 On August 19, 2019, I completed examinations of the above listed items for Detective

9 [REDACTED] Detective [REDACTED] requested I extract all user data from the devices for the date

10 range of 02-12-19 through 08-12-19.

11

12 Detective [REDACTED] provided me with a copy of signed Riverside County Search Warrant and

13 Affidavit #RI081320196 authorizing the search of the items listed above.

14 I got the items from Detective [REDACTED]

15

16

17 **Examinations:**

18 **Item #1 (Coolpad Cell Phone):**

19

20

21 The phone contained a SanDisk 32 GB Micro SD memory card which I removed and

22 examined separately. See item #2 below for details.

23

24 The phone was locked with an unknown Secure Start-Up PIN.

25

26 **Item #2 (SanDisk Memory Card):**

27

28 I ran a Physical Extraction on the memory card using UFED 4PC 7.21.0.31. I conducted

29 my examination using UFED Physical Analyzer 7.22.0.109.



Riverside Police Department

Officer Report

File Number:
190023109-060

30

31 **Findings:**

32

33 **Item #1 (Coolpad Cell Phone):**

34

35 The phone was connected to the Metro by T-Mobile cellular network. The phone
36 number assigned to the phone was 909-717-7185.

37

38 No data was extracted from the phone.

39

40

41 **Item #2 (SanDisk Memory Card):**

42

43 I extracted the following for inclusion in the digital evidence report:

44 · 636 Images

45 · 9 Videos

46

47 **Disposition:**

48

49 The examination findings are contained in an examination report. I copied the report to a
50 DVD which I gave to Detective [REDACTED]. The report is in HTML format and can be viewed
51 with an internet browser. To view the report, open the file "Report Viewer".

52

53 Items not fitting the search criteria authorized by the provided Search Warrant and Affidavit
54 were not included in the digital evidence report and remained "sealed" in the digital
55 extraction.

56

57 I gave the items back to Detective [REDACTED]

58



Riverside Police Department

Officer Report

File Number:
190023109-061

Administrative Information

Subject:	1111 - OFFICER NEEDS BACK-UP/URGENT RESPONSE				
Date(s) and Time(s) of Occurrence Or Between:	//				
Location Of Occurrence:	Box Springs Bldg / Eastridge Ave RIVERSIDE				
Date/Time Reported:	8/12/2019 5:38:06 PM	Day:			
Date Of Report:	8/20/2019 2:30:14 PM	Type Of Premises:			
NPC:		RD:	PG08	Beat:	3
Was There a Witness To The Crime?					
Can a Suspect Be Named Or Identified?		By Whom?			
Can a Suspect Vehicle Be Identified?		By Whom?			

Code Section Classification:

Records Section

Reporting Officer:	[REDACTED]		
115 Qualified:	Yes		
Send Copies Of This Report To:			
DOJ/NCIC Entered?		Name/ID	
DOJ/NCIC Cancelled?		Name/ID	
APR Sent?		Name/ID	
APB Sent?		Name/ID	

Public Narrative

Supervisor Approving

Approving Supervisor:	[REDACTED]
Date Reviewed:	8/20/2019 12:00:00 AM

Evidence Information

Physical Evidence Present?		Physical Evidence Seized?	
----------------------------	--	---------------------------	--



Riverside Police Department

Officer Report

File Number:
190023109-061

Photographs Taken?		Photographer?	
Weapon Seized?		Weapon(s) Taken For Safety?	
Gang Related?		Sensitive Data?	
Fingerprint Search Made?		Fingerprints Obtained?	
Narcotics Seized?		Narcotics Field Tested?	
Audio Recording Available?		In Car Recording Available?	
Body Worn Camera Recording Available?			
Type of Weapon, Force, Or Device Used?			
Motive:			

Narrative

1 **Additional File:**

2 RSO - MC192240003

3

4 **Narrative:**

5 On Monday, August 12, 2019, at about 1800 hours, I learned of an officer involved
6 shooting that was in progress involving California Highway Patrol (CHP) Officers,
7 Riverside Police Officers and other local law enforcement agencies. I responded to the
8 Command Post located at Eastridge St. and Box Springs Rd., in the city of Riverside.

9

10 I attended a briefing of the incident provided by Riverside Police Sergeant [REDACTED]
11 Riverside County Sheriff's Sergeant [REDACTED] and California Highway Patrol Captain
12 [REDACTED]. The preliminary information from the briefing was that California Highway Patrol
13 Officer A. Moye was in the process of impounding a vehicle when the suspect retrieved
14 a firearm from the vehicle and began firing at Officer Moye and assisting California
15 Highway Patrol Officer [REDACTED] who was also on-scene. Officer Moye and Officer [REDACTED]
16 both sustained gunshot wounds and several officers and deputies from multiple
17 agencies responded to assist with the active shooter. During the ensuing shootout,
18 California Highway Patrol Officers [REDACTED] Riverside Police
19 Department Officer K. Feimer, and Riverside County Sheriff Department Deputies
20 [REDACTED] discharged their firearms.

21

22 CHP Officer Moye was transported to Riverside University Health Systems Medical
23 Center via the Riverside Police Department helicopter, Air1. CHP Officer [REDACTED] was
24 transported by a Riverside Sheriff's Department vehicle to the same hospital. The
25 suspect, later identified as Aaron Nathaniel Luther, was transported by American
26 Medical Response ambulance to the same hospital. CHP Officer Moye and Luther
27 succumbed to their injuries at the hospital and CHP Officer [REDACTED] was in critical
28 condition.



Riverside Police Department

Officer Report

File Number:
190023109-061

29
30 Following the briefing, Detective [REDACTED] was assigned as the case agent and
31 Detective [REDACTED] as the co-case agent. Sergeant [REDACTED], Detective [REDACTED]
32 and Senior Forensic Specialist [REDACTED] responded to the RUHS to collect evidence on
33 the involved officers, the transport vehicles and the suspect. Detective [REDACTED] and
34 Supervising Forensic Specialist [REDACTED] were assigned to process/chart the
35 Riverside County Sheriff's Department employees weapons at the Moreno Valley Police
36 station. Detective [REDACTED] was assigned to assist with the scene and processing/charting
37 the California Highway Patrol officers at the CHP, Riverside office located at 8118
38 Lincoln Avenue, Riverside. Detective [REDACTED], Detective [REDACTED], Detective [REDACTED]
39 [REDACTED] and Senior Forensic Specialist [REDACTED] were assigned to process the crime
40 scene. I was assigned as the Scene Supervisor.

41
42 I participated in a scene walk-through. Based on the size of the scene, the evidence
43 needed to be collected and the fact that it was dark, we determined we would be
44 better suited to hold the scene until daylight. This would ensure a more thorough
45 canvass and collection.

46 Patrol Sgt. [REDACTED] and I coordinated the overall containment of the scene including
47 having two detectives [REDACTED] within the scene keeping watch of the
48 evidence including the Police vehicles, civilian vehicles and fire vehicles. I cleared the
49 scene at about 0300 hours and returned the following morning at 0600 hours.

50 At about 0800 hours, I called Detective [REDACTED] and Officer [REDACTED] to the scene to record
51 video and take still photographs of the scene using a department unmanned Arial
52 System (Drone).

53 I maintained scene supervision throughout the day and oversaw the processing of the
54 evidence until about 0430 hours, on Wednesday, August 14, 2019. During that time I
55 coordinated the release of vehicles inside the scene that were no longer needed. After
56 leaving the scene I responded to the Magnolia Police Station where I coordinated the
57 placement of (9) involved vehicles held for evidence. Three were placed inside
58 evidence bays and the remaining were placed in our secured parking lot. I cleared at
59 about 0500 hrs. NFI.

60
61



Riverside Police Department

Officer Report

File Number:
190023109-062

Administrative Information

Subject: 1111 - OFFICER NEEDS BACK-UP/URGENT RESPONSE				
Date(s) and Time(s) of Occurrence Or Between: //				
Location Of Occurrence: Box Springs Bldg / Eastridge Ave RIVERSIDE				
Date/Time Reported:	8/12/2019 5:38:06 PM	Day:		
Date Of Report:	8/20/2019 2:55:27 PM	Type Of Premises:		
NPC:		RD:	PG08	Beat: 3
Was There a Witness To The Crime?				
Can a Suspect Be Named Or Identified?		By Whom?		
Can a Suspect Vehicle Be Identified?		By Whom?		

Code Section Classification:

Records Section

Reporting Officer:	[REDACTED]		
115 Qualified:	Yes		
Send Copies Of This Report To:			
DOJ/NCIC Entered?		Name/ID	
DOJ/NCIC Cancelled?		Name/ID	
APR Sent?		Name/ID	
APB Sent?		Name/ID	

Public Narrative

Supervisor Approving

Approving Supervisor:	[REDACTED]
Date Reviewed:	8/22/2019 12:00:00 AM

Evidence Information

Physical Evidence Present?		Physical Evidence Seized?	
----------------------------	--	---------------------------	--



Riverside Police Department

Officer Report

File Number:
190023109-062

Photographs Taken?		Photographer?	
Weapon Seized?		Weapon(s) Taken For Safety?	
Gang Related?		Sensitive Data?	
Fingerprint Search Made?		Fingerprints Obtained?	
Narcotics Seized?		Narcotics Field Tested?	
Audio Recording Available?		In Car Recording Available?	
Body Worn Camera Recording Available?			
Type of Weapon, Force, Or Device Used?			
Motive:			

Narrative

1 **ADDITIONAL AGENCY:**

2 Riverside County Sheriff's Department- Coroner Bureau (West)
 3 Deputy Coroner [REDACTED]
 4 Coroner case# for CHP Officer Andre Moye (2019-09734)
 5 Coroner case# for suspect Aaron Luther (2019-09736)

7 **ASSISTING RPD PERSONNEL:**

8 Senior Forensic Evidence Specialist [REDACTED]

10 **BACKGROUND/SOURCE:**

11 I am a Detective with the Riverside Police Department assigned to the Centralized
 12 Investigations Bureau Persons Unit. On 08-12-19 at 1814 hours, I was called out to
 13 assist with the investigation of the homicide of California Highway Patrol Officer Andre
 14 Moye and subsequent Officer Involved Shooting (OIS) that occurred in the area of Box
 15 Springs Blvd. and Eastridge Ave., in the City and County of Riverside (see Case Report
 16 and Officer Reports for further details).

18 I arrived at the command post (Box Springs Blvd. and Eastridge Ave.) at 1919 hours,
 19 and was assigned by Sergeant [REDACTED] to respond to Riverside University Health
 20 System Medical Center (RUHSMC) to process Officer Moye and Luther's bodies for
 21 potential evidence and to collect any potential items of evidence from the hospital.

23 **INVESTIGATION:**

24 I arrived at RUHSMC at 1949 hours and contacted Deputy Coroner [REDACTED] in the
 25 emergency room (ER). She was standing by with Officer Moye and Luther. I was given
 26 a briefing by Riverside County Sheriff's Department Central Homicide Unit (CHU)
 27 Detective [REDACTED]. He told me that Officer Moye was pronounced deceased at



Riverside Police Department

Officer Report

File Number:
190023109-062

28 1818 hours by Doctor [REDACTED]. Luther was pronounced deceased at 1833 hours,
29 also by Doctor [REDACTED]. Senior Forensic Evidence Specialist [REDACTED] arrived at the ER and
30 we began processing Officer Moye at approximately 2040 hours.

31

32 **PROCESSING OF OFFICER MOYE:**

33 I observed the listed items being collected from Officer Moye, and his ER room, by
34 Senior Forensic Evidence Specialist [REDACTED], with assistance from Deputy Coroner [REDACTED]
35 (see Senior Forensic Evidence Specialist [REDACTED] Officer Report for details on all the
36 evidence collected and photographs taken including clothing and equipment belonging
37 to CHP Officer [REDACTED].

38

- 39 · American Flag
- 40 · Hospital blankets
- 41 · Buccal swabs
- 42 · GSR Kit
- 43 · Hand swabs
- 44 · Nail clippings
- 45 · Motorcycle helmet
- 46 · Duty belt with 2 loaded magazines
- 47 · Uniform pants
- 48 · Uniform shirt
- 49 · White undershirt
- 50 · Motor boots
- 51 · Folding knife
- 52 · Flashlight
- 53 · Duty vest
- 54 · Black socks
- 55 · Black boxer briefs and shirt keepers
- 56 · Cell phone

57

58 **PROCESSING OF AARON LUTHER:**

59 We began processing Luther at approximately 2337 hours. I observed the listed items
60 being collected from Luther by Senior Forensic Evidence Specialist [REDACTED] with
61 assistance from Deputy Coroner [REDACTED] (see Senior Forensic Evidence Specialist
62 [REDACTED] Officer Report for details on all the evidence collected and photographs taken).

63

- 64 · Buccal swabs
- 65 · GSR Kit
- 66 · Hand swabs
- 67 · Wallet
- 68 · Handcuffs
- 69 · Black shirt
- 70 · Boxer briefs



Riverside Police Department

Officer Report

File Number:
190023109-062

71
72 Senior Forensic Evidence Specialis [REDACTED] and I cleared from RUHSMC on 08-13-19 at
73 0048 hours.

74

75 **CHARTING OF OFFICER MOYE'S FIREARM AND MAGAZINES:**

76 On 08-15-19 at 0810 hours, I was present during the charting of Officer Moye's
77 firearm and magazines at the Magnolia Police Station Forensic Unit's Office. I also
78 assisted Senior Forensic Evidence Specialist [REDACTED] with the charting process (see her
79 Officer Report for details).

80

81 No further information.

82

RIVERSIDE POLICE DEPARTMENT

Date Printed: 10/30/2022 11:28	Case Report Number: 190023109-062	Page: 4 of 4	Ver. 1.3.3
-----------------------------------	--------------------------------------	-----------------	---------------



Riverside Police Department

Officer Report

File Number:
190023109-065

Administrative Information

Subject:	1111 - OFFICER NEEDS BACK-UP/URGENT RESPONSE				
Date(s) and Time(s) of Occurrence Or Between:	//				
Location Of Occurrence:	Box Springs Bldg / Eastridge Ave RIVERSIDE				
Date/Time Reported:	8/12/2019 5:38:06 PM	Day:			
Date Of Report:	8/20/2019 4:31:27 PM	Type Of Premises:			
NPC:		RD:	PG08	Beat:	3
Was There a Witness To The Crime?					
Can a Suspect Be Named Or Identified?			By Whom?		
Can a Suspect Vehicle Be Identified?			By Whom?		

Code Section Classification:

Records Section

Reporting Officer:	[REDACTED]		
115 Qualified:	Yes		
Send Copies Of This Report To:			
DOJ/NCIC Entered?		Name/ID	
DOJ/NCIC Cancelled?		Name/ID	
APR Sent?		Name/ID	
APB Sent?		Name/ID	

Public Narrative

Supervisor Approving

Approving Supervisor:	[REDACTED]
Date Reviewed:	8/20/2019 12:00:00 AM

Evidence Information

Physical Evidence Present?		Physical Evidence Seized?	
----------------------------	--	---------------------------	--



Riverside Police Department

Officer Report

File Number:
190023109-065

Photographs Taken?		Photographer?	
Weapon Seized?		Weapon(s) Taken For Safety?	
Gang Related?		Sensitive Data?	
Fingerprint Search Made?		Fingerprints Obtained?	
Narcotics Seized?		Narcotics Field Tested?	
Audio Recording Available?		In Car Recording Available?	
Body Worn Camera Recording Available?			
Type of Weapon, Force, Or Device Used?			
Motive:			

Narrative

- 1 On 08/20/2019 at approximately 1545 hours , I made contact with W/ [REDACTED] (Valleywide Tow Truck)
- 2 at his place of business located at 24850 Rivard Rd., Moreno Valley CA. Upon arrival, W/ [REDACTED] gave
- 3 me the CHP 180 Vehicle Report Officer Moye handed him; before the shooting started. W/ [REDACTED]
- 4 said the CHP 180 had been in his possession since 08/12/19.
- 5 I then returned to the Magnolia St police station and entered the CHP 180 Vehicle Report as
- 6 evidence to case 19-0023109.
- 7
- 8 NFD
- 9



Riverside Police Department

Officer Report

File Number:
190023109-066

Administrative Information

Subject:	1111 - OFFICER NEEDS BACK-UP/URGENT RESPONSE				
Date(s) and Time(s) of Occurrence Or Between:	//				
Location Of Occurrence:	Box Springs Bldg / Eastridge Ave RIVERSIDE				
Date/Time Reported:	8/12/2019 5:38:06 PM	Day:			
Date Of Report:	8/21/2019 10:00:03 AM	Type Of Premises:			
NPC:		RD:	PG08	Beat:	3
Was There a Witness To The Crime?					
Can a Suspect Be Named Or Identified?			By Whom?		
Can a Suspect Vehicle Be Identified?			By Whom?		

Code Section Classification:

Records Section

Reporting Officer:	[REDACTED]		
115 Qualified:	Yes		
Send Copies Of This Report To:			
DOJ/NCIC Entered?		Name/ID	
DOJ/NCIC Cancelled?		Name/ID	
APR Sent?		Name/ID	
APB Sent?		Name/ID	

Public Narrative

Supervisor Approving

Approving Supervisor:	[REDACTED]
Date Reviewed:	8/23/2019 12:00:00 AM

Evidence Information

Physical Evidence Present?		Physical Evidence Seized?	
----------------------------	--	---------------------------	--



Riverside Police Department

Officer Report

File Number:
190023109-066

Photographs Taken?		Photographer?	
Weapon Seized?		Weapon(s) Taken For Safety?	
Gang Related?		Sensitive Data?	
Fingerprint Search Made?		Fingerprints Obtained?	
Narcotics Seized?		Narcotics Field Tested?	
Audio Recording Available?		In Car Recording Available?	
Body Worn Camera Recording Available?			
Type of Weapon, Force, Or Device Used?			
Motive:			

Narrative

- 1 On 08/12/19 at approximately 1945 hrs, I was telephonically contacted by Lt. [REDACTED] to respond to
- 2 the Riverside University Medical Center (RUMC), reference standing-by with the City of Riverside
- 3 Police Department's helicopter, N911RP. At approximately 2100 hrs, I arrived at the location and met
- 4 with Lt. [REDACTED].
- 5 Upon speaking with Lt. [REDACTED], I was instructed to stay with the helicopter until it was processed by
- 6 RPD Crime Scene Investigators. At approximately 2200 hours, Sgt. [REDACTED] advised me investigators
- 7 had completed processing the aircraft and I was cleared to fly it back to the Riverside Police
- 8 Department's hangar, located at 7020 Central Ave, Riverside, CA 92504. Due to activity related to the
- 9 transferring of the deceased CHP Officer's body to the Riverside County Coroner's Office, I was not
- 10 able to depart from the hospital until approximately 2330 hours. At approximately 2340 hours, I
- 11 arrived with the aircraft at RPD's hangar, where I parked it inside the hangar and secured it with
- 12 crime scene tape.
- 13 NFI
- 14



Riverside Police Department

Officer Report

File Number:
190023109-067

Administrative Information

Subject:		1111 - OFFICER NEEDS BACK-UP/URGENT RESPONSE			
Date(s) and Time(s) of Occurrence Or Between:		//			
Location Of Occurrence:		Box Springs Bldg / Eastridge Ave RIVERSIDE			
Date/Time Reported:	8/15/2019 4:00:00 PM	Day:			
Date Of Report:	9/4/2019 3:10:00 PM	Type Of Premises:			
NPC:		RD:	PG08	Beat:	3
Was There a Witness To The Crime?					
Can a Suspect Be Named Or Identified?		By Whom?			
Can a Suspect Vehicle Be Identified?		By Whom?			

Code Section Classification:

Records Section

Reporting Officer:	[REDACTED]				
115 Qualified:	No				
Send Copies Of This Report To:					
DOJ/NCIC Entered?		Name/ID			
DOJ/NCIC Cancelled?		Name/ID			
APR Sent?		Name/ID			
APB Sent?		Name/ID			

Public Narrative

Supervisor Approving

Approving Supervisor:	[REDACTED]				
Date Reviewed:	9/5/2019 12:00:00 AM				

Evidence Information

Physical Evidence Present?		Physical Evidence Seized?	
----------------------------	--	---------------------------	--



Riverside Police Department

Officer Report

File Number:
190023109-067

Photographs Taken?		Photographer?	
Weapon Seized?		Weapon(s) Taken For Safety?	
Gang Related?		Sensitive Data?	
Fingerprint Search Made?		Fingerprints Obtained?	
Narcotics Seized?		Narcotics Field Tested?	
Audio Recording Available?		In Car Recording Available?	
Body Worn Camera Recording Available?			
Type of Weapon, Force, Or Device Used?			
Motive:			

Property Information

Property:	Truck (not Stolen or Recovered)		
UCR Description			
IBR Type	37	UCR Type	V - Other Vehicle (not Stolen or Recovered)
Description:			
License No:	[REDACTED]		
Status:	Evidence (Seized)		
Uninhabited:			
Count:		Value:	
Property Owner:			
Manufacturer		Model	
Serial Number	[REDACTED]	Owner Applied Number	
Finish		Condition	
Color:			
Identifying Marks			
Recovered Date:		Disposition:	
Evidence Tag:			

Bicycle Information (If Applicable)

Make:		Model:	
Speed:		Wheel Size:	

Vehicle Information (If Applicable)

Type	22 - Pickups and Panels
Make	GMC



Riverside Police Department

Officer Report

File Number:
190023109-067

Model		Sonoma	
Year		Odometer Reading	
VIN			
Body Style	Pickup Truck	License State	California
License Plate Type:			
License Expiration Date:	08-2018		
Boat Information (If Applicable)			
Boat Name:			
Boat Type:			
HIN:			
Hull Shape			
Propulsion			
Boat Length			
Vehicle/Bicycle/Boat Color Information (If Applicable)			
Vehicle Color Type		Vehicle Color	
PR - Primary		WHI - White	
Is Vehicle Stored?		Was the vehicle involved in a collision?	
Was the collision reported?		Related Cases:	
Drug Information (If Applicable)			
Drug Type:			
Drug Quantity:		Drug Measure:	
Property Information			
Property:	Police Motorcycle (not Stolen or Recovered)		
UCR Description			
IBR Type	24	UCR Type	V - Other Vehicle (not Stolen or Recovered)
Description:			
License No:	[REDACTED]		
Status:	Evidence (Seized)		
Uninhabited:			
Count:		Value:	
Property Owner:			
Manufacturer		Model	



Riverside Police Department

Officer Report

File Number:
190023109-067

Serial Number		Owner Applied Number	
Finish		Condition	
Color:			
Identifying Marks			
Recovered Date:		Disposition:	
Evidence Tag:			
Bicycle Information (If Applicable)			
Make:		Model:	
Speed:		Wheel Size:	
Vehicle Information (If Applicable)			
Type	49 - Police Motorcycle		
Make	Harley-Davidson		
Model			
Year		Odometer Reading	
VIN			
Body Style		License State	California
License Plate Type:			
License Expiration Date:			
Boat Information (If Applicable)			
Boat Name:			
Boat Type:			
HIN:			
Hull Shape			
Propulsion			
Boat Length			
Vehicle/Bicycle/Boat Color Information (If Applicable)			
Vehicle Color Type	Vehicle Color		
PR - Primary	BLK - Black		
SE - Secondary	WHI - White		
Is Vehicle Stored?		Was the vehicle involved in a collision?	
Was the collision reported?		Related Cases:	
Drug Information (If Applicable)			
Drug Type:			



Riverside Police Department

Officer Report

File Number:
190023109-067

Drug Quantity:		Drug Measure:	
----------------	--	---------------	--

Property Information

Property:	Automobile (not Stolen or Recovered)		
UCR Description			
IBR Type	03	UCR Type	V - Other Vehicle (not Stolen or Recovered)
Description:			
License No:	[REDACTED]		
Status:	Evidence (Seized)		
Uninhabited:			
Count:		Value:	
Property Owner:			
Manufacturer		Model	
Serial Number	[REDACTED]	Owner Applied Number	
Finish		Condition	
Color:			
Identifying Marks			
Recovered Date:		Disposition:	
Evidence Tag:			

Bicycle Information (If Applicable)

Make:		Model:	
Speed:		Wheel Size:	

Vehicle Information (If Applicable)

Type	01 - Passenger Car, StationWagon, Jeep		
Make	Toyota		
Model	Corolla		
Year		Odometer Reading	
VIN			
Body Style	Sedan, 4-door	License State	California
License Plate Type:			
License Expiration Date:	06-2020		

Boat Information (If Applicable)

Boat Name:	
Boat Type:	



Riverside Police Department

Officer Report

File Number:
190023109-067

HIN:			
Hull Shape			
Propulsion			
Boat Length			
Vehicle/Bicycle/Boat Color Information (If Applicable)			
Vehicle Color Type	Vehicle Color		
PR - Primary	SIL - Silver or Aluminum		
Is Vehicle Stored?		Was the vehicle involved in a collision?	
Was the collision reported?		Related Cases:	
Drug Information (If Applicable)			
Drug Type:			
Drug Quantity:		Drug Measure:	
Property Information			
Property:	Automobile (not Stolen or Recovered)		
UCR Description			
IBR Type	03	UCR Type	V - Other Vehicle (not Stolen or Recovered)
Description:			
License No:	[REDACTED]		
Status:	Evidence (Seized)		
Uninhabited:			
Count:		Value:	
Property Owner:			
Manufacturer		Model	
Serial Number	[REDACTED]	Owner Applied Number	
Finish		Condition	
Color:			
Identifying Marks			
Recovered Date:		Disposition:	
Evidence Tag:			
Bicycle Information (If Applicable)			
Make:		Model:	
Speed:		Wheel Size:	



Riverside Police Department

Officer Report

File Number:
190023109-067

Vehicle Information (If Applicable)

Type	01 - Passenger Car, StationWagon, Jeep		
Make	Kia		
Model	Optima		
Year		Odometer Reading	
VIN			
Body Style	Sedan, 4-door	License State	California
License Plate Type:			
License Expiration Date:	07-2020		

Boat Information (If Applicable)

Boat Name:	
Boat Type:	
HIN:	
Hull Shape	
Propulsion	
Boat Length	

Vehicle/Bicycle/Boat Color Information (If Applicable)

Vehicle Color Type	Vehicle Color
PR - Primary	WHI - White
Is Vehicle Stored?	Was the vehicle involved in a collision?
Was the collision reported?	Related Cases:

Drug Information (If Applicable)

Drug Type:	
Drug Quantity:	Drug Measure:

Property Information

Property:	Police Automobile (not Stolen or Recovered)		
UCR Description			
IBR Type	03	UCR Type	V - Other Vehicle (not Stolen or Recovered)
Description:			
License No:	[REDACTED]		
Status:	Evidence (Seized)		
Uninhabited:			



Riverside Police Department

Officer Report

File Number:
190023109-067

Count:		Value:	
Property Owner:			
Manufacturer		Model	
Serial Number	██████████	Owner Applied Number	
Finish		Condition	
Color:			
Identifying Marks			
Recovered Date:		Disposition:	
Evidence Tag:			
Bicycle Information (If Applicable)			
Make:		Model:	
Speed:		Wheel Size:	
Vehicle Information (If Applicable)			
Type	48 - Police Car		
Make	Ford		
Model	Crown Victoria Police Interceptor		
Year		Odometer Reading	
VIN			
Body Style	Sedan, 4-door	License State	California
License Plate Type:			
License Expiration Date:			
Boat Information (If Applicable)			
Boat Name:			
Boat Type:			
HIN:			
Hull Shape			
Propulsion			
Boat Length			
Vehicle/Bicycle/Boat Color Information (If Applicable)			
Vehicle Color Type	Vehicle Color		
PR - Primary	BLK - Black		
SE - Secondary	WHI - White		
Is Vehicle Stored?		Was the vehicle involved in a collision?	



Riverside Police Department

Officer Report

File Number:
190023109-067

Was the collision reported?		Related Cases:	
Drug Information (If Applicable)			
Drug Type:			
Drug Quantity:		Drug Measure:	
Property Information			
Property:	Police Automobile (not Stolen or Recovered)		
UCR Description			
IBR Type	03	UCR Type	V - Other Vehicle (not Stolen or Recovered)
Description:			
License No:	[REDACTED]		
Status:	Evidence (Seized)		
Uninhabited:			
Count:		Value:	
Property Owner:			
Manufacturer		Model	
Serial Number	[REDACTED]	Owner Applied Number	
Finish		Condition	
Color:			
Identifying Marks			
Recovered Date:		Disposition:	
Evidence Tag:			
Bicycle Information (If Applicable)			
Make:		Model:	
Speed:		Wheel Size:	
Vehicle Information (If Applicable)			
Type	48 - Police Car		
Make	Dodge		
Model	Charger		
Year		Odometer Reading	
VIN			
Body Style	Sedan, 4-door	License State	California
License Plate Type:			
License Expiration Date:			



Riverside Police Department

Officer Report

File Number:
190023109-067

Boat Information (If Applicable)

Boat Name:	
Boat Type:	
HIN:	
Hull Shape	
Propulsion	
Boat Length	

Vehicle/Bicycle/Boat Color Information (If Applicable)

Vehicle Color Type	Vehicle Color
PR - Primary	BLK - Black
SE - Secondary	WHI - White
Is Vehicle Stored?	Was the vehicle involved in a collision?
Was the collision reported?	Related Cases:

Drug Information (If Applicable)

Drug Type:	
Drug Quantity:	Drug Measure:

Property Information

Property:	Police Automobile (not Stolen or Recovered)		
UCR Description			
IBR Type	03	UCR Type	V - Other Vehicle (not Stolen or Recovered)
Description:			
License No:	[REDACTED]		
Status:	Evidence (Seized)		
Uninhabited:			
Count:		Value:	
Property Owner:			
Manufacturer		Model	
Serial Number	[REDACTED]	Owner Applied Number	
Finish		Condition	
Color:			
Identifying Marks			
Recovered Date:		Disposition:	



Riverside Police Department

Officer Report

File Number:
190023109-067

Evidence Tag:			
Bicycle Information (If Applicable)			
Make:		Model:	
Speed:		Wheel Size:	
Vehicle Information (If Applicable)			
Type	48 - Police Car		
Make	Ford		
Model	Explorer		
Year		Odometer Reading	
VIN			
Body Style	Sport Utility Vehicle	License State	California
License Plate Type:			
License Expiration Date:			
Boat Information (If Applicable)			
Boat Name:			
Boat Type:			
HIN:			
Hull Shape			
Propulsion			
Boat Length			
Vehicle/Bicycle/Boat Color Information (If Applicable)			
Vehicle Color Type	Vehicle Color		
PR - Primary	BLK - Black		
SE - Secondary	WHI - White		
Is Vehicle Stored?		Was the vehicle involved in a collision?	
Was the collision reported?		Related Cases:	
Drug Information (If Applicable)			
Drug Type:			
Drug Quantity:		Drug Measure:	
Property Information			
Property:	Truck (not Stolen or Recovered)		
UCR Description			



Riverside Police Department

Officer Report

File Number:
190023109-067

IBR Type	37	UCR Type	V - Other Vehicle (not
Description:			
License No:	[REDACTED]		
Status:	Evidence (Seized)		
Uninhabited:			
Count:		Value:	
Property Owner:			
Manufacturer		Model	
Serial Number	[REDACTED]	Owner Applied Number	
Finish		Condition	
Color:			
Identifying Marks			
Recovered Date:		Disposition:	
Evidence Tag:			
Bicycle Information (If Applicable)			
Make:		Model:	
Speed:		Wheel Size:	
Vehicle Information (If Applicable)			
Type	22 - Pickups and Panels		
Make	Ford		
Model	F150		
Year		Odometer Reading	
VIN			
Body Style	Pickup Truck	License State	California
License Plate Type:			
License Expiration Date:	03-2020		
Boat Information (If Applicable)			
Boat Name:			
Boat Type:			
HIN:			
Hull Shape			
Propulsion			
Boat Length			



Riverside Police Department

Officer Report

File Number:
190023109-067

Vehicle/Bicycle/Boat Color Information (If Applicable)			
Vehicle Color Type		Vehicle Color	
PR - Primary		WHI - White	
Is Vehicle Stored?		Was the vehicle involved in a collision?	
Was the collision reported?		Related Cases:	
Drug Information (If Applicable)			
Drug Type:			
Drug Quantity:		Drug Measure:	
Property Information			
Property:	Automobile (not Stolen or Recovered)		
UCR Description			
IBR Type	03	UCR Type	V - Other Vehicle (not Stolen or Recovered)
Description:			
License No:	[REDACTED]		
Status:	Evidence (Seized)		
Uninhabited:			
Count:		Value:	
Property Owner:			
Manufacturer		Model	
Serial Number	[REDACTED]	Owner Applied Number	
Finish		Condition	
Color:			
Identifying Marks			
Recovered Date:		Disposition:	
Evidence Tag:			
Bicycle Information (If Applicable)			
Make:		Model:	
Speed:		Wheel Size:	
Vehicle Information (If Applicable)			
Type	01 - Passenger Car, StationWagon, Jeep		
Make	Honda		
Model	Accord		



Riverside Police Department

Officer Report

File Number:
190023109-067

Year		Odometer Reading	
VIN			
Body Style	Sedan, 4-door	License State	California
License Plate Type:			
License Expiration Date:	11-2019		
Boat Information (If Applicable)			
Boat Name:			
Boat Type:			
HIN:			
Hull Shape			
Propulsion			
Boat Length			
Vehicle/Bicycle/Boat Color Information (If Applicable)			
Vehicle Color Type	Vehicle Color		
PR - Primary	BLK - Black		
Is Vehicle Stored?		Was the vehicle involved in a collision?	
Was the collision reported?		Related Cases:	
Drug Information (If Applicable)			
Drug Type:			
Drug Quantity:		Drug Measure:	

Narrative

1 On 08/15/2019, I received notification from Detective [REDACTED] that the TOYOTA COROLLA seized
 2 for evidence during this investigation could be released to the registered owner. At 1952 hours, I met
 3 with registered owner [REDACTED] at the Riverside Police Department Magnolia police facility and
 4 released the TOYOTA COROLLA to her. I modified the original CLETS SVS entry to reflect the vehicle's
 5 change in status.
 6
 7 On 08/29/2019, I received notification from Detective [REDACTED] that the GMC SONOMA and the
 8 KIA OPTIMA seized for evidence during this investigation could be released to the tow yard and the
 9 evidence hold removed. At 1343 hours, I met with [REDACTED] of Bauman's Towing, at the Magnolia Police
 10 facility and released the GMC SONOMA to him for transport to their secured yard. I completed a CHP
 11 180 form to document the vehicle condition and change in location. At 1439 hours, I met with [REDACTED]
 [REDACTED] of Exclusive Towing, at the Magnolia Police facility and released the KIA OPTIMA to him for



Riverside Police Department

Officer Report

File Number:
190023109-067

13 transport to their secured yard. I completed a CHP 180 form to document the vehicle condition and
14 change in location.
15 At 1631 hours, at the request of Detective [REDACTED], I notified Exclusive Towing via email of the
16 removal of the evidence hold and modified the original CLETS SVS entry to reflect the KIA OPTIMA's
17 change in status. I mailed Notice of Stored Vehicle letters to the registered owner and to the legal
18 owner using the addresses provided through the DMV vehicle registration system to provide notification
19 of the vehicle's change in status.
20
21 On 09/03/2019, I mailed a Notice of Stored Vehicle letter addressed to the estate of the registered
22 owner of the GMC SONOMA using the address provided through the DMV vehicle registration system to
23 provide notification of the vehicle's change in status. I notified Bauman's Towing via email of the
24 removal of the evidence hold and I modified the original CLETS SVS entry to reflect the GMC SONOMA's
25 change in status. At 1534 hours, I was notified by Forensic Evidence Tech Supervisor [REDACTED] that
26 all law enforcement vehicles seized for evidence during this investigation had been released back to
27 their respective departments. I modified each of the original CLETS SVS entries to reflect the change in
28 status for those vehicles.
29

RIVERSIDE POLICE DEPARTMENT



Riverside Police Department

Officer Report

File Number:
190023109-068

Administrative Information

Subject:	1111 - OFFICER NEEDS BACK-UP/URGENT RESPONSE				
Date(s) and Time(s) of Occurrence Or Between:	//				
Location Of Occurrence:	Box Springs Bldg / Eastridge Ave RIVERSIDE				
Date/Time Reported:	8/12/2019 5:38:06 PM	Day:			
Date Of Report:	8/22/2019 3:17:42 PM	Type Of Premises:			
NPC:		RD:	PG08	Beat:	3
Was There a Witness To The Crime?					
Can a Suspect Be Named Or Identified?		By Whom?			
Can a Suspect Vehicle Be Identified?		By Whom?			

Code Section Classification:

Records Section

Reporting Officer:	[REDACTED]		
115 Qualified:	Yes		
Send Copies Of This Report To:			
DOJ/NCIC Entered?		Name/ID	
DOJ/NCIC Cancelled?		Name/ID	
APR Sent?		Name/ID	
APB Sent?		Name/ID	

Public Narrative

Supervisor Approving

Approving Supervisor:	[REDACTED]
Date Reviewed:	8/23/2019 12:00:00 AM

Other Entities

Name:	Goetz, Dustin
-------	---------------



Riverside Police Department

Officer Report

File Number:
190023109-068

Entity Type:	Other (Person)		Code:		
Sex:		Race:		DOB:	
Height:		Weight:			
Hair:		Eyes:			
Notes:					

Witness Addresses:

Address Type	Address	City, State ZIP	County
█	█	█	

Witness Phones:

Phone Type	Phone Number
█	█

Evidence Information

Physical Evidence Present?		Physical Evidence Seized?	
Photographs Taken?		Photographer?	
Weapon Seized?		Weapon(s) Taken For Safety?	
Gang Related?		Sensitive Data?	
Fingerprint Search Made?		Fingerprints Obtained?	
Narcotics Seized?		Narcotics Field Tested?	
Audio Recording Available?		In Car Recording Available?	
Body Worn Camera Recording Available?			
Type of Weapon, Force, Or Device Used?			
Motive:			

Narrative

1 **SUMMARY:**

2 This Officer Report covers the interview of Riverside County Sheriff's Deputy █

3 █

4 █

5 **INVESTIGATION:**

6 Interview of Deputy █



Riverside Police Department

Officer Report

File Number:
190023109-068

7 On 08-21-19 at approximately 1300 hours, Detective [REDACTED] and I interviewed
8 the involved Riverside County Sheriff's Deputy, [REDACTED] in the conference room at
9 the Magnolia Police Station. Also present during the interview was Riverside County
10 Deputy District Attorney [REDACTED] Riverside County District Attorney's Office
11 Investigator [REDACTED] Riverside County District Attorney's Office Investigator
12 [REDACTED], and Deputy [REDACTED] attorney [REDACTED]. The interview was
13 recorded on my Department issued digital recorder and later downloaded. The
14 following is a summary of that interview.

15
16 Detective [REDACTED] started the interview by advising Deputy [REDACTED] that this was a
17 criminal report that would be submitted to the District Attorney's Office for review. He
18 told him he did not have to speak with us and that he could not be disciplined for not
19 speaking with us. Detective [REDACTED] asked Deputy [REDACTED] other than the public
20 safety statement, has anyone ordered him to give a statement and he said no. Deputy
21 [REDACTED] was asked if he wished to speak to us at that time and he said yes.

22
23 Deputy [REDACTED] then provided the following information: Date of birth [REDACTED]
24 Employee ID# [REDACTED] over 11 years of service (all with the Riverside County Sheriff's
25 Department), currently assigned to the Robbery/Burglary Suppression Team at the
26 Moreno Valley Station, 6'2", 235 lbs., Date of hire 04-20-08, patrol start date was 05-13-
27 13, Rank is Deputy Sheriff, call sign was 5Moreno220, Unit #08228 (two man unit with
28 Deputy [REDACTED]), and the uniform he was wearing at the time of the incident was
29 his department issued raid vest with "Sheriff" on the front and back over a black shirt
30 and blue jeans. Deputy [REDACTED] said he was wearing a body camera that was activated
31 during the incident.

32
33 Deputy [REDACTED] was asked if he had a chance to review all known audio/video
34 recordings of the incident and he said yes. He was asked what weapon he used during
35 the incident and how was it loaded or configured. He said he used his Glock 22 40
36 Caliber handgun which was loaded to capacity (fifteen or sixteen rounds plus one in the
37 chamber). Deputy [REDACTED] said he fired one round and was not injured during the
38 incident.

39
40 Deputy [REDACTED] said he was in plain clothes at the station. He heard dispatch over the
41 radio stating that CHP was on a stop and were asking for help and there had been
42 shots fired in the area of Eastridge and the 215. Deputy [REDACTED] and his partner, Deputy
43 [REDACTED], jumped in their unit and headed out to the scene. Deputy [REDACTED] drove
44 and Deputy [REDACTED] sat in the front passenger seat. The radio traffic in route was
45 choppy but he heard shots were being fired, but he was not sure on which direction.

46
47 He said he followed a black and white unit (RSO unit with Deputy [REDACTED] and his
48 trainee) with its lights and sirens on to the area. They traveled westbound Alessandro,
49 past the 215 to Sycamore, then headed north to Eastridge. The black and white unit



Riverside Police Department

Officer Report

File Number:
190023109-068

50 blocked the intersection at Sycamore and Eastridge, and Deputy [REDACTED] became the
51 lead unit. He travelled east to the overpass and as he pulled up he could see the truck
52 (suspect's vehicle), some units facing westbound, and some civilian cars stopped along
53 the shoulder of the overpass.

54
55 Deputy [REDACTED] stopped behind the civilian cars. His partner grabbed the rifle from
56 their unit and exited the passenger door. Deputy [REDACTED] exited the driver seat and met
57 up with his partner at the rear of the unit. At that point, other assisting units started
58 pulling up. Deputy [REDACTED] said as soon as he turned onto Eastridge he could hear the
59 gunshots. When he met up with the other deputies, somebody mentioned something
60 about civilians in the cars (parked on the shoulder). As they were contacting the
61 civilians, he could see the suspect on the hood of his truck, shooting towards the CHP
62 and RSO officers behind the suspect (to the east).

63
64 Deputy [REDACTED] contacted a Black or Hispanic male with long hair in a silver or black
65 car and told him to get out and directed him to safety. Deputy [REDACTED] noticed a silver
66 jeep that was the vehicle furthest up the shoulder. He asked for two additional officers
67 (one being Deputy [REDACTED] the other was unknown) and they ran up to the jeep.
68 Deputy [REDACTED] opened the rear passenger side door of the jeep and told the driver to
69 climb out the car towards him. Deputy [REDACTED] then moved to the front of the jeep and
70 took a knee at the front passenger side.

71
72 Deputy [REDACTED] saw the suspect who was sitting down on his butt, leaning forward,
73 and moving his hands around. Deputy [REDACTED] said based off of everything that occurred
74 up to that point, the suspect shooting at police, Deputy [REDACTED] knowing that it was a
75 busy on ramp with people below it, and that the suspect appeared to not care about
76 anybody (who was in the area of the shooting), he decided to take the shot. He said he
77 had a pretty good sight on the suspect, he saw a dirt background, and he saw the
78 suspect's torso, put his front sight on the suspect's torso, and shot one round. The
79 suspect immediately fell back.

80
81 Deputy [REDACTED] said he only fired the one shot because it was the only clear shot he
82 had, then the suspect went down, so he did not feel the need to fire additional shots.
83 When the officers behind the suspect started to move up, Deputy [REDACTED] backed off.
84 Once the suspect was in custody and it was determined that no other suspects were
85 involved, it was pretty much done. He walked back to his unit where his Body Worn
86 Camera (which was turned on immediately after the shot) was collected by Sergeant
87 [REDACTED] Deputy [REDACTED] was then transported back to his station.

88
89 Detective [REDACTED] asked Deputy [REDACTED] if he heard any rounds coming towards
90 their location to the west. Deputy [REDACTED] said he could not tell if they were coming
91 towards them. As they got closer to the suspect the shots got louder and louder and
92 louder, so they knew they were at the right spot. He could not tell if they were taking

Date Printed: 10/30/2022 11:35	Case Report Number: 190023109-068	Page: 4 of 5	Ver. 1.3.3
--	---	------------------------	----------------------



Riverside Police Department

Officer Report

File Number:
190023109-068

93 rounds but they were cautious and scared to get out of the car because of that. But the
94 first time he saw the suspect, the suspect was shooting back towards the other
95 direction. He said the suspect was wearing dark clothing and the truck was white.

96
97 Deputy [REDACTED] estimated he was forty to fifty yards from the suspect when he took
98 the shot from the kneeling position. Detective [REDACTED] had Deputy [REDACTED] indicate on
99 a set of photographs of the crime scene, what he had just described to us during his
100 interview in regards to positioning and movements (the photos were later collected and
101 placed into a property locker at the Magnolia Station).

102
103 We asked Deputy [REDACTED] to clarify what he saw near the suspect's hands when he
104 saw the suspect sitting in front of the truck. He said they were dark items and he did not
105 see a firearm. We asked what was going through his mind right before he took the shot.
106 Deputy [REDACTED] said he was scared, scared for the officers that were with him, as well as
107 the officers that were behind the suspect that were trying to help the initial CHP officers
108 that had been hurt. Deputy [REDACTED] felt the suspect was going to continue to shoot. The
109 suspect showed no signs of stopping. It was a scary situation and he felt the suspect
110 was going to keep going. This concluded the interview.

111
112 **No further information.**

113

RIVERSIDE POLICE DEPARTMENT



Riverside Police Department

Officer Report

File Number:
190023109-069

Administrative Information

Subject:	1111 - OFFICER NEEDS BACK-UP/URGENT RESPONSE				
Date(s) and Time(s) of Occurrence Or Between:	//				
Location Of Occurrence:	Box Springs Bldg / Eastridge Ave RIVERSIDE				
Date/Time Reported:	8/12/2019 5:38:06 PM	Day:			
Date Of Report:	8/23/2019 3:25:56 PM	Type Of Premises:			
NPC:		RD:	PG08	Beat:	3
Was There a Witness To The Crime?					
Can a Suspect Be Named Or Identified?		By Whom?			
Can a Suspect Vehicle Be Identified?		By Whom?			

Code Section Classification:

Records Section

Reporting Officer:	[REDACTED]		
115 Qualified:	Yes		
Send Copies Of This Report To:			
DOJ/NCIC Entered?		Name/ID	
DOJ/NCIC Cancelled?		Name/ID	
APR Sent?		Name/ID	
APB Sent?		Name/ID	

Public Narrative

Supervisor Approving

Approving Supervisor:	[REDACTED]
Date Reviewed:	8/27/2019 12:00:00 AM

Victim Information

PURSUANT TO CALIFORNIA PENAL CODE SECTION 293(a)/CONFIDENTIAL FORM(S) ATTACHED?:			
Code:		Name:	[REDACTED]
Victim Type:	Law Enforcement Officer	Will the victim prosecute?	



Riverside Police Department

Officer Report

File Number:
190023109-069

Sex:		Race:		DOB:	
Height:		Weight:			
Hair:		Eyes:			
Notes:					

Victim Scars, Marks and Tattoos

Scar, Mark, Tattoo	Scar, Mark, Tattoo Location	Description
--------------------	-----------------------------	-------------

Victim Domestic Violence Information (If Applicable)

Emotional State:	Appearance:	Injuries:	Sobriety/Drug:
Victim Advised of Citizen's Arrest Rights?			
Victim Given "Alternatives To Domestic Violence" Card?			
Victim Given Agency Report Number?			
Victim Given Department Phone Number?			
Victim Advised Of Public Record/Privacy, 293(a) PC?			

Victim Vehicle Information:

Make	Model	Year	Color	License No.
------	-------	------	-------	-------------

Victim Injuries:

Injuries:	
If Treated For Injuries, By Whom?	
If Hospitalized, Where?	
Date/Time:	
Nature of Injuries:	
Injury Weapons:	

Victim Addresses:

Address Type	Address	City, State ZIP	County

Victim Phones:

--	--



Riverside Police Department

Officer Report

File Number:
190023109-069

--	--

Evidence Information

Physical Evidence Present?		Physical Evidence Seized?	
Photographs Taken?		Photographer?	
Weapon Seized?		Weapon(s) Taken For Safety?	
Gang Related?		Sensitive Data?	
Fingerprint Search Made?		Fingerprints Obtained?	
Narcotics Seized?		Narcotics Field Tested?	
Audio Recording Available?		In Car Recording Available?	
Body Worn Camera Recording Available?			
Type of Weapon, Force, Or Device Used?			
Motive:			

Narrative

SUMMARY:

This Officer Report covers the interview of Riverside County Sheriff's Deputy [REDACTED]

INVESTIGATION:

Interview of Deputy [REDACTED]

On 08-21-19 at approximately 1342 hours, Detective [REDACTED] interviewed the involved Riverside County Sheriff's Deputy, [REDACTED] in the conference room at the Magnolia Police Station. Also present during the interview was Riverside County Deputy District Attorney [REDACTED] Riverside County District Attorney's Office Investigator [REDACTED], Riverside County District Attorney's [REDACTED] interview was recorded on my Department issued digital recorder and later downloaded. The following is a summary of that interview.

Detective [REDACTED] started the interview by advising Deputy [REDACTED] that this was a criminal report that would be submitted to the District Attorney's Office for review. He told him he did not have to speak with us and that he could not be disciplined for not speaking with us. Detective [REDACTED] asked Deputy [REDACTED] other than the public



Riverside Police Department

Officer Report

File Number:
190023109-069

20 safety statement, has anyone ordered him to give a statement and he said no. Deputy
21 [REDACTED] was asked if he wished to speak to us at that time and he said yes.

22
23 Deputy [REDACTED] then provided the following information: Date of birth [REDACTED]
24 Employee ID# [REDACTED], 18 [REDACTED] of service (all with the Riverside County Sheriff's
25 Department), currently assigned to the Moreno Valley Station graveyard shift 1700-0500
26 hours, 5'7", 183 lbs., Date of hire 05-17-01, patrol start date was July 2003, Rank is
27 Deputy Sheriff, call sign was 1Moreno31, Unit #11246 (two man unit with trainee Deputy
28 [REDACTED], and the uniform he was wearing at the time of the incident was his
29 Riverside County Deputy Sheriff Class C uniform (tan and green) with a green pull over
30 vest clearly marked with "Police" on the front, back and sides. Deputy [REDACTED] said he
31 was wearing a body camera that was activated during the incident.

32
33 Deputy [REDACTED] was asked if he had a chance to review all known audio/video
34 recordings of the incident and he said yes. He was asked what weapon he used during
35 the incident and how was it loaded or configured. He said he used his Springfield
36 Armory MOD 2 9mm handgun which was loaded to capacity (sixteen rounds plus one in
37 the chamber) plus two additional magazines of sixteen rounds. Deputy [REDACTED] said he
38 fired approximately nine rounds and was not injured during the incident.

39
40 Deputy [REDACTED] said at around 1737 hours, they received a patrol call that was an
41 11-11 (emergency back-up for an officer) for CHP, and that CHP officers were in a
42 gunfight. He and his trainee took the call and were primary on the call. They travelled to
43 the location from the area of Frederick and Alessandro. Their route of travel was
44 eastbound Alessandro, northbound on the 215 freeway, then they exited Eucalyptus
45 and crossed over the freeway westbound to Eastridge. Upon arrival they positioned
46 their vehicle behind a CHP unit. Deputy [REDACTED] exited the passenger side and his
47 trainee exited the driver's side. Deputy [REDACTED] saw what appeared to be a male down
48 on the ground. He heard shots but did not know exactly who was shooting at that time.

49
50 Deputy [REDACTED] said there was an additional CHP officer standing near an SUV CHP
51 Unit. He realized the down male was a CHP motor officer who did not appear to be
52 moving. He then heard several gunshots that appeared to be return fire from an
53 unknown subject. He asked one of the CHP officers (unknown which one) where the
54 person was who was firing and they just said, "Over there." Deputy [REDACTED] gathered
55 that the suspect shooting at them was either in front of a CHP car or further east (later
56 clarified to be west) of their location.

57
58 Deputy [REDACTED] and his trainee retreated to the rear of their patrol car. He said it
59 was an intense firefight with a lot of gunshots going off. He moved to the driver's side of
60 his unit, switching spots with Deputy [REDACTED] At that point he saw the male suspect,
61 who peeked out from the front of the CHP unit. The suspect looked directly at him and

Date Printed: 10/30/2022 11:36	Case Report Number: 190023109-069	Page: 4 of 5	Ver. 1.3.3
-----------------------------------	--------------------------------------	-----------------	---------------



Riverside Police Department

Officer Report

File Number:
190023109-069

62 Deputy [REDACTED] fired nine rounds toward the suspect. The suspect retreated back to the
63 front of the CHP unit. Deputy [REDACTED] returned to the rear of his unit for cover.

64
65 For the next two or three minutes he was giving information out over his radio as to
66 where the suspect was and what was going on. Deputy [REDACTED] then noticed a CHP
67 Officer pulling another CHP Officer who had been shot in the leg. When CHP reached
68 the back bumper of Deputy [REDACTED] vehicle, Deputy [REDACTED] instructed Deputy
69 [REDACTED] to provide cover fire if needed. Deputy [REDACTED] and the CHP Officer dragged
70 the injured CHP Officer back to an awaiting patrol car. They loaded the injured CHP
71 Officer into the back of a vehicle and Deputy [REDACTED] got into the passenger seat and
72 they drove him to the hospital. Deputy [REDACTED] said when he got to the hospital he got
73 into a patrol car that was assigned to the hospital deputy, and drove back to the scene.
74 Deputy [REDACTED] was then transported to the station.

75
76 Deputy [REDACTED] said the downed CHP motor officer was approximately three and a
77 half to four car lengths away from them when they pulled up to the scene. Detective
78 [REDACTED] asked Deputy [REDACTED] if he saw or heard any of the suspect's rounds striking
79 near him. Deputy [REDACTED] said after he shot at the suspect, the driver's side door
80 window either shattered or was shot out, but he was not sure. Deputy [REDACTED] said the
81 suspect was approximately two to two and half car lengths in front of him when he shot
82 his nine rounds. He said the suspect was a White male in all black and had a goatee.
83 He said the suspect had something in his hands but he could not tell exactly what it was
84 because it was down to his side.

85
86 Detective [REDACTED] asked Deputy [REDACTED] what was his mindset right before he
87 fired nine rounds towards the suspect. Deputy [REDACTED] said he thought that he needed
88 to eliminate this threat. He was scared. Deputy [REDACTED] said he was in the front
89 passenger seat of the patrol unit that transported CHP Officer [REDACTED] to the hospital. He
90 said Deputy [REDACTED] was in the back seat with Officer [REDACTED] talking to him and
91 administering first aid on his legs.

92
93 Detective [REDACTED] had Deputy [REDACTED] indicate on a set of photographs of the crime
94 scene, what he had just described to us during his interview in regards to positioning
95 and movements (the photos were later collected and placed into a property locker at the
96 Magnolia Station). This concluded the interview.

97
98 **No further information.**

99

Date Printed: 10/30/2022 11:36	Case Report Number: 190023109-069	Page: 5 of 5	Ver. 1.3.3
-----------------------------------	--------------------------------------	-----------------	---------------



Riverside Police Department

Officer Report

File Number:
190023109-070

Administrative Information

Subject:		1111 - OFFICER NEEDS BACK-UP/URGENT RESPONSE			
Date(s) and Time(s) of Occurrence Or Between:		//			
Location Of Occurrence:		Box Springs Bldg / Eastridge Ave RIVERSIDE			
Date/Time Reported:	8/12/2019 5:38:06 PM	Day:			
Date Of Report:	8/26/2019 3:24:50 PM	Type Of Premises:			
NPC:		RD:	PG08	Beat:	3
Was There a Witness To The Crime?					
Can a Suspect Be Named Or Identified?		By Whom?			
Can a Suspect Vehicle Be Identified?		By Whom?			

Code Section Classification:

Records Section

Reporting Officer:	[REDACTED]				
115 Qualified:	Yes				
Send Copies Of This Report To:					
DOJ/NCIC Entered?		Name/ID			
DOJ/NCIC Cancelled?		Name/ID			
APR Sent?		Name/ID			
APB Sent?		Name/ID			

Public Narrative

I submitted evidence to the Scientific Investigations Division at SBSD Crime Lab for firearms analysis.

Supervisor Approving

Approving Supervisor:	[REDACTED]				
Date Reviewed:	8/27/2019 12:00:00 AM				

Evidence Information

Physical Evidence Present?		Physical Evidence Seized?	
----------------------------	--	---------------------------	--



Riverside Police Department

Officer Report

File Number:
190023109-070

Photographs Taken?		Photographer?	
Weapon Seized?		Weapon(s) Taken For Safety?	
Gang Related?		Sensitive Data?	
Fingerprint Search Made?		Fingerprints Obtained?	
Narcotics Seized?		Narcotics Field Tested?	
Audio Recording Available?		In Car Recording Available?	
Body Worn Camera Recording Available?			
Type of Weapon, Force, Or Device Used?			
Motive:			

Narrative

- 1 On 8/22/19, I attempted to deliver evidence items to SBSB Crime Lab for analysis. Due to traffic, I was unable
- 2 to deliver the items before they closed. I returned the items to Magnolia Station and booked them into
- 3 evidence.
- 4
- 5 On 8/23/19 at approximately 1105 hours, I submitted the following items to the Scientific Investigation
- 6 Division at SBSB Crime Lab for firearm analysis (function test):
- 7
- 8 KF01, KF01A, KF01B
- 9 BE04, BE04A, BE04B
- 10 DG01, DG01A, DG01B
- 11 MCHAV01, MCHA01A, MCHA01B
- 12 OV58, OV58A
- 13 VM01, VM01A, VM01B, VM01C
- 14
- 15
- 16 On 8/26/19 at approximately 1230 hours, I submitted the following items to the Scientific Investigation
- 17 Division at SBSB Crime Lab for firearm analysis (function test):
- 18
- 19
- 20 SMI02, SMI02A, SMI02B, SMI02C
- 21
- 22
- 23
- 24



Riverside Police Department

Officer Report

File Number:
190023109-071

Administrative Information

Subject:		1111 - OFFICER NEEDS BACK-UP/URGENT RESPONSE			
Date(s) and Time(s) of Occurrence Or Between:		//			
Location Of Occurrence:		Box Springs Bldg / Eastridge Ave RIVERSIDE			
Date/Time Reported:	8/12/2019 5:38:06 PM	Day:			
Date Of Report:	8/27/2019 3:41:44 PM	Type Of Premises:			
NPC:		RD:	PG08	Beat:	3
Was There a Witness To The Crime?					
Can a Suspect Be Named Or Identified?		By Whom?			
Can a Suspect Vehicle Be Identified?		By Whom?			

Code Section Classification:

Records Section

Reporting Officer:	[REDACTED]				
115 Qualified:	No				
Send Copies Of This Report To:					
DOJ/NCIC Entered?		Name/ID			
DOJ/NCIC Cancelled?		Name/ID			
APR Sent?		Name/ID			
APB Sent?		Name/ID			

Public Narrative

Supervisor Approving

Approving Supervisor:	[REDACTED]				
Date Reviewed:	9/11/2019 12:00:00 AM				

Evidence Information

Physical Evidence Present?		Physical Evidence Seized?	
----------------------------	--	---------------------------	--



Riverside Police Department

Officer Report

File Number:
190023109-071

Photographs Taken?	Yes	Photographer?	1913 - Meyer, Rebecca
Weapon Seized?		Weapon(s) Taken For Safety?	No
Gang Related?	Unknown	Sensitive Data?	No
Fingerprint Search Made?	No	Fingerprints Obtained?	N/A
Narcotics Seized?		Narcotics Field Tested?	No
Audio Recording Available?	No	In Car Recording Available?	Unknown
Body Worn Camera Recording Available?	Unknown		
Type of Weapon, Force, Or Device Used?			
Motive:			

Narrative

1 **Case Type:**

2 187 PC / Homicide
3 OIS / Officer Involved Shooting
4

5 **Service Requested:**

6 On 08/22/19, at approximately 0700 hours, I was requested, by FORENSIC SUPERVISOR S.
7 [REDACTED] to respond to the Forensic Unit Garage, at the RPD Magnolia Station, 10540
8 Magnolia Avenue, St. B, in order to process a California Highway Patrol (CHP) Motor Unit,
9 license plate [REDACTED]
10

11 **Photographs Taken:**

12 At approximately 0710 hours, I took overall photographs showing the exterior of the motor unit.
13 I labeled and photographed a possible strike mark (label A) to the front windshield.
14

15 With the assistance of CHP OFFICER [REDACTED], I photographed multiple personal
16 and duty items located inside the motor unit saddle bags. I took overall, midrange, and close-up
17 views showing these items; including a CHP Citation and a CHP 180 form located inside metal
18 clip boards. These (49) photographs were uploaded into the Digital Information Management
19 System (DIMS).
20

21 **Evidence Collected:**

22 I collected each item that was removed from the saddle bags. These items were sorted, packaged,
23 and labeled MOTOR01-MOTOR04. See my attachments (Property Log and Evidence Log) for
24 further. I immediately placed each of these items in the secure Forensic Unit Evidence Vault.
25

26 **Evidence Disposition:**



Riverside Police Department

Officer Report

File Number:
190023109-071

27 On 08/27/19, at approximately 1050 hours, I removed each of these items from the Evidence
28 Vault and released them to Magnolia Station Property Locker #38.
29
30 No further action was taken.
31

RIVERSIDE POLICE DEPARTMENT

Date Printed: 10/30/2022 11:38	Case Report Number: 190023109-071	Page: 3 of 3	Ver. 1.3.3
--	---	------------------------	----------------------



Riverside Police Department

Officer Report

File Number:
190023109-074

Administrative Information

Subject:	1111 - OFFICER NEEDS BACK-UP/URGENT RESPONSE				
Date(s) and Time(s) of Occurrence Or Between:	//				
Location Of Occurrence:	Box Springs Bldg / Eastridge Ave RIVERSIDE				
Date/Time Reported:	8/12/2019 5:38:06 PM	Day:			
Date Of Report:	8/29/2019 2:01:23 PM	Type Of Premises:			
NPC:		RD:	PG08	Beat:	3
Was There a Witness To The Crime?					
Can a Suspect Be Named Or Identified?		By Whom?			
Can a Suspect Vehicle Be Identified?		By Whom?			

Code Section Classification:

Records Section

Reporting Officer:	[REDACTED]		
115 Qualified:	Yes		
Send Copies Of This Report To:			
DOJ/NCIC Entered?		Name/ID	
DOJ/NCIC Cancelled?		Name/ID	
APR Sent?		Name/ID	
APB Sent?		Name/ID	

Public Narrative

Supervising Forensic Specialist [REDACTED] and I processed the scene located in the back parking area of 6596 Box Springs Blvd.

Supervisor Approving

Approving Supervisor:	[REDACTED]
Date Reviewed:	8/30/2019 12:00:00 AM

Evidence Information



Riverside Police Department

Officer Report

File Number:
190023109-074

Physical Evidence Present?		Physical Evidence Seized?	
Photographs Taken?		Photographer?	
Weapon Seized?		Weapon(s) Taken For Safety?	
Gang Related?		Sensitive Data?	
Fingerprint Search Made?		Fingerprints Obtained?	
Narcotics Seized?		Narcotics Field Tested?	
Audio Recording Available?		In Car Recording Available?	
Body Worn Camera Recording Available?			
Type of Weapon, Force, Or Device Used?			
Motive:			

Narrative

1 On 08-12-19, at approximately 1830 hours, I was asked to respond to Box Springs Boulevard and
 2 Eastridge Avenue, in the City and County of Riverside to assist with an Officer Involved Shooting
 3 investigation.

4
 5
 6 I attended a briefing of the incident provided by Riverside Police Department Sergeant [REDACTED], Riverside
 7 County Sheriff's Sergeant [REDACTED] and California Highway Patrol Captain [REDACTED]. The preliminary
 8 information from the briefing was California Highway Patrol Officer Moyer was in the process of towing a
 9 vehicle he stopped; the suspect retrieved a firearm from his vehicle and began firing at Officer Moyer and
 10 California Highway Patrol Officer [REDACTED]. Both Officer Moyer and Officer [REDACTED] sustained gunshot wounds.
 11 Several officers and deputies from multiple agencies responded to assist with the active shooter
 12 suspect.

13
 14
 15 During the ensuing shootout, California Highway Patrol Officers [REDACTED] Riverside Police
 16 Department Officer K. Feimer, and Riverside County Sheriff Department Deputies [REDACTED] and
 17 [REDACTED] discharged their firearms.

18
 19
 20 CHP Officer Moyer was transported to Riverside University Health Systems Medical Center in Moreno
 21 Valley in the Riverside Police Department helicopter, Air1. CHP Officer [REDACTED] was transported by a
 22 Riverside Sheriff's Department vehicle to the same hospital. The suspect, later identified as Aaron
 23 Nathaniel Luther, was transported by American Medical Response ambulance to Riverside University
 24 Health Systems Medical Center.

25
 26



Riverside Police Department

Officer Report

File Number:
190023109-074

27 CHP Officer Moye and suspect Aaron Luther succumbed to their injuries at the hospital. CHP Officer
28 [REDACTED] was severely injured and required surgery.

29
30
31 Following the briefing, Detective [REDACTED] was assigned as the case agent and Detective [REDACTED] as
32 the co-case agent. Detective [REDACTED] and Senior Forensic Specialist [REDACTED] responded to the hospital.
33 Detective [REDACTED] Detective [REDACTED] and Senior Forensic Specialist [REDACTED] and I were assigned to process
34 the crime scene. Detective [REDACTED] and Supervising Forensic Specialist [REDACTED] were assigned to
35 process/chart the Riverside County Sheriff's Department employees' weapons at the Moreno Valley
36 Police station. Detective [REDACTED] was assigned to assist with the scene and processing/charting the
37 California Highway Patrol officers at the CHP, Riverside office. Supervising Forensic Specialist [REDACTED]
38 [REDACTED] returned to the scene to further assist. She and I processed the scene located in the back parking
39 lot area of 6596 Box Springs Boulevard (Vision Heating and Air Conditioning).

40
41
42 This portion of the scene was the rear parking lot of the Vision business. There was a flat bed type "Big
43 Tex" trailer parked in the space. There was also a covered "EZ Hauler" trailer (CA LP# [REDACTED]) parked
44 next to the flat bed trailer. There was a wrought iron type fence between the back parking lot and the
45 parking area located on the north side of the building. The "EZ Hauler" trailer was parked closest to the
46 rear of the building. There were possible strike marks above the trailer on the east wall of the building
47 (Items BMB, BMC and BMD). Riverside Fire Department assisted by providing a ladder for Supervising
48 Forensic Specialist [REDACTED] to access the strike marks on the building. There were holes in the
49 covered trailer consistent with a bullet passing through it, (*moving east to west*) exiting the trailer and
50 striking the wall (Item BMA). Supervising Forensic Specialist [REDACTED] took overall photographs of
51 the scene. Possible bullet fragments (Items BM01-BM03) were located on the ground outside of the
52 wrought iron type fence.

53
54
55 Supervising Forensic Specialist [REDACTED] collected the items and booked them into evidence.

56
57
58
59
60
61



Riverside Police Department

Officer Report

File Number:
190023109-075

Administrative Information

Subject:	1111 - OFFICER NEEDS BACK-UP/URGENT RESPONSE				
Date(s) and Time(s) of Occurrence Or Between:	//				
Location Of Occurrence:	Box Springs Bldg / Eastridge Ave RIVERSIDE				
Date/Time Reported:	8/12/2019 5:38:06 PM	Day:			
Date Of Report:	9/3/2019 9:26:20 AM	Type Of Premises:			
NPC:		RD:	PG08	Beat:	3
Was There a Witness To The Crime?					
Can a Suspect Be Named Or Identified?		By Whom?			
Can a Suspect Vehicle Be Identified?		By Whom?			

Code Section Classification:

Records Section

Reporting Officer:	[REDACTED]		
115 Qualified:	No		
Send Copies Of This Report To:			
DOJ/NCIC Entered?		Name/ID	
DOJ/NCIC Cancelled?		Name/ID	
APR Sent?		Name/ID	
APB Sent?		Name/ID	

Public Narrative

Supervisor Approving

Approving Supervisor:	[REDACTED]
Date Reviewed:	9/11/2019 12:00:00 AM

Evidence Information

Physical Evidence Present?		Physical Evidence Seized?	
----------------------------	--	---------------------------	--



Riverside Police Department

Officer Report

File Number:
190023109-075

Photographs Taken?	Yes	Photographer?	[REDACTED]
Weapon Seized?		Weapon(s) Taken For Safety?	Yes
Gang Related?	No	Sensitive Data?	No
Fingerprint Search Made?	No	Fingerprints Obtained?	N/A
Narcotics Seized?		Narcotics Field Tested?	No
Audio Recording Available?	No	In Car Recording Available?	No
Body Worn Camera Recording Available?	No		
Type of Weapon, Force, Or Device Used?			
Motive:			

Narrative

1 **Case Type:**

2 187 PC / Homicide
3 OIS / Officer Involved Shooting
4

5 **Service Requested:**

6 On 08/16/19, at approximately 0900 hours, I was requested, by DETECTIVE [REDACTED], to
7 respond to the rear parking area of the RPD Magnolia Station, 10540 Magnolia Avenue, St. B, in
8 order to process California Highway Patrol (CHP) Unit #560, license plate [REDACTED]. I was also
9 requested to photograph and chart any weapon(s) removed from the vehicle.
10

11 **Photographs Taken:**

12 I took overall exterior and interior photographs of Unit #560. I located, labeled, and
13 photographed a number of possible strike marks throughout the exterior and the interior sides of
14 the vehicle. See my attachment (*Strike Mark Log*) for further.
15

16 I also located and photographed a number of projectiles and possible bullet fragments throughout
17 the interior and exterior sides of the vehicle. These items were marked with placards 1 and 3-16.

18 *NOTE: I was assisted with disassembling multiple areas of the vehicle by SR. PD MACHANICS, [REDACTED]
[REDACTED] and [REDACTED]. This was necessary for evidence location and retrieval.*
19
20

21 With the assistance of RPD DETECTIVE [REDACTED] and CHP OFFICER [REDACTED], I
22 photographed the Remington 870 Police Magnum, 12 gauge shotgun, serial #A585356M that
23 was removed from the center console rack. I completed a charting form for this weapon. See my
24 attachment (*Gun Chart Form CHP Unit 560*) for further.
25

26 **Evidence Collected:**



Riverside Police Department

Officer Report

File Number:
190023109-075

27 I collected the Remington 12 gauge shotgun, (4) live shot gun shells from the magazine tube, and
28 (5) live shot gun shells from the stock magazine pouch. Each of these items were packaged and
29 labeled OM002, OM002A, and OM002B.

30

31 I also collected each of the possible projectiles and possible fragments (placards 1 and 3-16).
32 These items were packaged and labeled OM001 and OM003-OM016.

33

34 I received a set of keys for CHP Unit #560 from DETECTIVE [REDACTED]. This set of keys was
35 packaged and labeled OM0017.

36

37 On 08/21/19, at approximately 1200 hours, I completed processing this vehicle. All items of
38 evidence remained in my possession until such time as they were secured in the Forensic Unit
39 Evidence Vault. See my attachments (*Property Log and Evidence Log*) for further.

40

41 **Evidence Disposition:**

42 On 08/27/19, at approximately 1050 hours, I removed each of the above items from the Forensic
43 Unit Evidence Vault and released them to Magnolia Station PROPERTY SPECIALIST [REDACTED]

44

45

46 No further action was taken.

47

RIVERSIDE POLICE DEPARTMENT



Riverside Police Department

Officer Report

File Number:
190023109-076

Administrative Information

Subject:		1111 - OFFICER NEEDS BACK-UP/URGENT RESPONSE			
Date(s) and Time(s) of Occurrence Or Between:		//			
Location Of Occurrence:		Box Springs Bldg / Eastridge Ave RIVERSIDE			
Date/Time Reported:	8/12/2019 5:38:06 PM	Day:			
Date Of Report:	9/3/2019 4:21:30 PM	Type Of Premises:			
NPC:		RD:	PG08	Beat:	3
Was There a Witness To The Crime?					
Can a Suspect Be Named Or Identified?		By Whom?			
Can a Suspect Vehicle Be Identified?		By Whom?			

Code Section Classification:

Records Section

Reporting Officer:	[REDACTED]				
115 Qualified:	Yes				
Send Copies Of This Report To:					
DOJ/NCIC Entered?		Name/ID			
DOJ/NCIC Cancelled?		Name/ID			
APR Sent?		Name/ID			
APB Sent?		Name/ID			

Public Narrative

Police vehicles released to the California Highway Patrol; Riverside Station

Supervisor Approving

Approving Supervisor:	[REDACTED]				
Date Reviewed:	9/11/2019 12:00:00 AM				

Evidence Information

Physical Evidence Present?		Physical Evidence Seized?	
----------------------------	--	---------------------------	--



Riverside Police Department

Officer Report

File Number:
190023109-076

Photographs Taken?		Photographer?	
Weapon Seized?		Weapon(s) Taken For Safety?	
Gang Related?		Sensitive Data?	
Fingerprint Search Made?		Fingerprints Obtained?	
Narcotics Seized?		Narcotics Field Tested?	
Audio Recording Available?		In Car Recording Available?	
Body Worn Camera Recording Available?			
Type of Weapon, Force, Or Device Used?			
Motive:			

Narrative

- 1 Narrative:
- 2 On Tuesday, September 03, 2019, I was working the Forensics Unit located at the Riverside Police
- 3 Department Magnolia Station located at 10540 Magnolia Ave. in the City of Riverside. At
- 4 approximately 1220 hours, CHP patrol vehicles 4455, 4560, and CHP motorcycle were turned over to
- 5 California Highway Patrol Sergeant [REDACTED]; Riverside Area Station.
- 6 No Further Details
- 7



Riverside Police Department

Officer Report

File Number:
190023109-077

Administrative Information

Subject:	1111 - OFFICER NEEDS BACK-UP/URGENT RESPONSE				
Date(s) and Time(s) of Occurrence Or Between:	//				
Location Of Occurrence:	Box Springs Bldg / Eastridge Ave RIVERSIDE				
Date/Time Reported:	8/12/2019 5:38:06 PM	Day:			
Date Of Report:	9/4/2019 8:56:45 AM	Type Of Premises:			
NPC:		RD:	PG08	Beat:	3
Was There a Witness To The Crime?					
Can a Suspect Be Named Or Identified?		By Whom?			
Can a Suspect Vehicle Be Identified?		By Whom?			

Code Section Classification:

Records Section

Reporting Officer:	[REDACTED]		
115 Qualified:	No		
Send Copies Of This Report To:			
DOJ/NCIC Entered?		Name/ID	
DOJ/NCIC Cancelled?		Name/ID	
APR Sent?		Name/ID	
APB Sent?		Name/ID	

Public Narrative

Supervisor Approving

Approving Supervisor:	[REDACTED]
Date Reviewed:	

Evidence Information

Physical Evidence Present?		Physical Evidence Seized?	
----------------------------	--	---------------------------	--



Riverside Police Department

Officer Report

File Number:
190023109-077

Photographs Taken?	Yes	Photographer?	[REDACTED]
Weapon Seized?		Weapon(s) Taken For Safety?	Yes
Gang Related?	Unknown	Sensitive Data?	Yes
Fingerprint Search Made?	No	Fingerprints Obtained?	N/A
Narcotics Seized?		Narcotics Field Tested?	No
Audio Recording Available?	No	In Car Recording Available?	No
Body Worn Camera Recording Available?	No		
Type of Weapon, Force, Or Device Used?			
Motive:			

Narrative

1
2 **Case Type:**

3
4 187 PC / Homicide
5 OIS / Officer Involved Shooting

6
7 **Service Requested:**

8
9 On 08/12/19, at approximately 1815 hours, I received a call-out request from SGT [REDACTED] to
10 respond to the Riverside County Health System Medical Center, 26520 Cactus Avenue, Moreno
11 Valley CA, to assist with a Homicide/Officer Involved Shooting Investigation. I arrived at
12 approximately 2030 hours, making contact with DETECTIVE [REDACTED] and SGT [REDACTED].

13
14 **Photographs Taken/
15 Evidence Collected and/or Received:**

16
17 CHP Officer Moye:

18 With the assistance of Riverside County DEPUTY CORONER [REDACTED], I took overall,
19 midrange and close-up photographs of victim, CALIFORNIA HIGHWAY PATROL (CHP)
20 OFFICER MOYE, ANDRE [REDACTED]. I took mid-range and close-up photographs
21 showing injuries to the left side of head (above ear), left shoulder, and left wrist area. I also took
22 photographs of items from the hospital, including MOYE'S clothing and duty items.

23
24 I collected a number of evidence items from victim, Moye. I also received a GSR Kit and nail
25 clippings from Moye, collected by Deputy Coroner [REDACTED]. These items were packaged and
26 labeled MOY005-023 and MOY026-027.

27



Riverside Police Department

Officer Report

File Number:
190023109-077

28 RPD Air-1:

29 At the request of SGT [REDACTED], I took overall exterior and interior photographs of Riverside
30 Police Department (RPD) helicopter (AIR 1, #N911RP). I took mid-range photographs locating
31 possible blood spatter to the rear seating area and floor. I was notified that this aircraft was used
32 for transportation.

33

34 CHP Officer Paul's Clothing and Duty items:

35 At the request of DETECTIVE [REDACTED] I took overall, mid-range, and close-up photographs
36 of clothing and duty items for CHP OFFICER [REDACTED]. These items
37 were located on the floor of the hospital. I was notified that Officer [REDACTED] was in surgery and
38 would not be available for photographs at this time.

39

40 I collected a number of evidence items said to belong to Officer [REDACTED]. These items were
41 packaged and labeled [REDACTED] 01-10.

42

43 Additional items received from CHP Officer [REDACTED]

44 At the request of SGT [REDACTED], I returned to the Emergency Room parking area to meet with
45 CHP OFFICER [REDACTED]. At my request, Officer [REDACTED] cleared the weapon for
46 safety. I received and photographed the Smith and Wesson M&P 40, serial #21620. I also
47 photographed the fully loaded (15 round) magazine and (1) live 40 caliber round removed from
48 the chamber. This weapon was said to belong to CHP Officer Moye. These items were packaged
49 and labeled MOY024-025.

50

51 I then received and photographed a watch and a duty belt containing an HT, taser, and other
52 misc. items. This duty belt was said to belong to CHP Officer [REDACTED]. These items were packaged
53 and labeled [REDACTED] 11-13.

54

55 RSO Moreno Valley PD Unit #11-137:

56 At the request of SGT [REDACTED], I took overall exterior and interior photographs of Riverside
57 Sheriff's Office, Moreno Valley Police Department unit #11-137, CA Exempt plate [REDACTED]. I
58 also took mid-range pictures showing possible blood to the back side of the cage in the rear seat
59 and on the driver floorboard area. I was informed that this unit was also used for transportation.

60

61 Suspect Luther, Aaron:

62 With the assistance of Riverside County DEPUTY CORONER [REDACTED], I took overall,
63 midrange and close-up photographs of suspect LUTHER, AARON [REDACTED]. I took mid-
64 range and close-up photographs showing injuries to his right side of chest, right side of back,
65 right shoulder, top of left hand and index finger, and left hip. I also photographed clothing and
66 personal items from Luther.

67

68 I collected a number of evidence items from suspect Luther. I also received a GSR Kit and nail
69 clippings from Luther, collected by Deputy Coroner [REDACTED]. These items were packaged and
70 labeled LUTH04-11.



Riverside Police Department

Officer Report

File Number:
190023109-077

71
72 Please see my attachments (*Property Report and Evidence Log*) for further. These (213)
73 photographs were uploaded into the Forensic Unit, Digital Information Management System
74 (DIMS).

75
76 At approximately 0100 hours, I completed my assignment and returned to the Magnolia Station,
77 Forensic Unit. I immediately secured each item of evidence in the Forensic Unit Evidence Vault
78 for further photographing.

79
80
81 **Follow-Up Photographs Taken:**

82
83 On 08/14/19, at the request of SGT [REDACTED] I removed the duty shirt for Officer Moye, from
84 the Drying Locker, in order to take additional photographs. I laid out Moye's duty shirt and
85 under-shirt. I took mid-range and close-up photographs showing damage to his shirt and of each
86 item removed from his shirt. These (24) additional photographs were uploaded into (DIMS).

87
88 At approximately 1556 hours, I released Officer Moye's Badge, name plate, (2) gold pens, and
89 cellphone/wallet to SGT. [REDACTED]

90
91 At approximately 1645 hours, the same day, I released Officer [REDACTED] wallet to SGT [REDACTED]

92
93 On 08/15/19, at approximately 0800 hours, I removed Moye's handgun (MOY024), magazine
94 with ammunition (MOY026), and duty belt (MOY013) from the Evidence Vault in order to take
95 additional photographs and to chart the weapon. With the assistance of DETECTIVE [REDACTED]
96 and CHP OFFICER [REDACTED], I took overall, mid-range, and close-up photographs of
97 the firearm (Smith and Wesson M&P 40, serial number HYY59191). I also photographed the
98 magazine, showing it fully loaded (15) rounds with the (1) additional round from the chamber. I
99 then photographed Moye's duty belt, showing (2) additional magazines in the holster. These
100 magazines were removed and photographed. Each magazine was also fully loaded with (15)
101 rounds each. Please see attachment (*Semi-Auto Chart Form*) for further.

102
103 I removed each additional item of evidence from the Evidence Vault. With the assistance of RPD
104 OFFICER [REDACTED] I laid out clothing and duty items from Officer Moye and Officer
105 [REDACTED] Each item was photographed, showing any damage located.

106
107 I then laid out clothing and personal items from suspect Luther. Each item was photographed,
108 showing any damage located. When completed, each item was secured in the Evidence Vault.

109
110 These (229) additional photographs were uploaded into (DIMS).

111
112 **Evidence Disposition:**

113

Date Printed: 10/30/2022 11:48	Case Report Number: 190023109-077	Page: 4 of 5	Ver. 1.3.3
-----------------------------------	--------------------------------------	-----------------	---------------



Riverside Police Department

Officer Report

File Number:
190023109-077

114 On 08/19/19, at approximately 1427 hours, each of the above listed items were released to
115 Magnolia Station PROPERTY SPECIALIST [REDACTED]. No further action was taken.
116

RIVERSIDE POLICE DEPARTMENT

Date Printed: 10/30/2022 11:48	Case Report Number: 190023109-077	Page: 5 of 5	Ver. 1.3.3
-----------------------------------	--------------------------------------	-----------------	---------------



Riverside Police Department

Officer Report

File Number:
190023109-078

Administrative Information

Subject:	1111 - OFFICER NEEDS BACK-UP/URGENT RESPONSE				
Date(s) and Time(s) of Occurrence Or Between:	//				
Location Of Occurrence:	Box Springs Bldg / Eastridge Ave RIVERSIDE				
Date/Time Reported:	8/12/2019 5:38:06 PM	Day:			
Date Of Report:	9/4/2019 1:30:25 PM	Type Of Premises:			
NPC:		RD:	PG08	Beat:	3
Was There a Witness To The Crime?					
Can a Suspect Be Named Or Identified?		By Whom?			
Can a Suspect Vehicle Be Identified?		By Whom?			

Code Section Classification:

Records Section

Reporting Officer:	[REDACTED]		
115 Qualified:	No		
Send Copies Of This Report To:			
DOJ/NCIC Entered?		Name/ID	
DOJ/NCIC Cancelled?		Name/ID	
APR Sent?		Name/ID	
APB Sent?		Name/ID	

Public Narrative

Supervisor Approving

Approving Supervisor:	[REDACTED]
Date Reviewed:	9/11/2019 12:00:00 AM

Evidence Information

Physical Evidence Present?		Physical Evidence Seized?	
----------------------------	--	---------------------------	--



Riverside Police Department

Officer Report

File Number:
190023109-078

Photographs Taken?		Photographer?	
Weapon Seized?		Weapon(s) Taken For Safety?	
Gang Related?		Sensitive Data?	
Fingerprint Search Made?		Fingerprints Obtained?	
Narcotics Seized?		Narcotics Field Tested?	
Audio Recording Available?		In Car Recording Available?	
Body Worn Camera Recording Available?			
Type of Weapon, Force, Or Device Used?			
Motive:			

Narrative

1
2 **Case Type:**
3 187PC / Homicide
4 OIS / Officer Involved Shooting
5
6 **Service Requested:**
7 On 08/13/19, at approximately 1250 hours, I was requested by SR. FORENSIC SPECIALIST [REDACTED]
8 [REDACTED] to respond to the scene of Box Springs Blvd and Eastridge Avenue, in order to assist
9 with a Homicide/Officer Involved Shooting Investigation. I arrived at approximately 1305 hours,
10 making contact with DETECTIVE [REDACTED]. He requested that I use a metal detector to search
11 the sidewalk and weeded field area located on the south side of Eastridge Avenue, east of Box
12 Springs Road for any additional fired cartridge cases and/or fragments.
13
14 Detective [REDACTED] and I searched the surrounding area using a Garrett AT-PRO Metal Detector.
15 We were unable to locate any additional items at this time. Due to the thick, rough weeded
16 terrain, it was determined that advanced equipment may be better suited for such a search. I
17 completed my assignment and left the scene at approximately 1500 hours.
18
19 No further action was taken.
20



Riverside Police Department

Officer Report

File Number:
190023109-080

Administrative Information

Subject:	1111 - OFFICER NEEDS BACK-UP/URGENT RESPONSE				
Date(s) and Time(s) of Occurrence Or Between:	//				
Location Of Occurrence:	Box Springs Bldg / Eastridge Ave RIVERSIDE				
Date/Time Reported:	8/12/2019 5:38:06 PM	Day:			
Date Of Report:	9/7/2019 12:47:32 PM	Type Of Premises:			
NPC:		RD:	PG08	Beat:	3
Was There a Witness To The Crime?					
Can a Suspect Be Named Or Identified?		By Whom?			
Can a Suspect Vehicle Be Identified?		By Whom?			

Code Section Classification:

Records Section

Reporting Officer:	[REDACTED]		
115 Qualified:	No		
Send Copies Of This Report To:			
DOJ/NCIC Entered?		Name/ID	
DOJ/NCIC Cancelled?		Name/ID	
APR Sent?		Name/ID	
APB Sent?		Name/ID	

Public Narrative

On 9/7/2019, while assisting Front Counter Orange Street, I received the attached courtesy report via mail from Riverside Sheriff's Office.

Riverside County Sheriff File #MC192240003, is attached to this report.

Supervisor Approving

Approving Supervisor:	[REDACTED]
Date Reviewed:	9/9/2019 12:00:00 AM



Riverside Police Department

Officer Report

File Number:
190023109-080

Evidence Information

Physical Evidence Present?		Physical Evidence Seized?	
Photographs Taken?		Photographer?	
Weapon Seized?		Weapon(s) Taken For Safety?	
Gang Related?		Sensitive Data?	
Fingerprint Search Made?		Fingerprints Obtained?	
Narcotics Seized?		Narcotics Field Tested?	
Audio Recording Available?		In Car Recording Available?	
Body Worn Camera Recording Available?			
Type of Weapon, Force, Or Device Used?			
Motive:			

Narrative

- 1 On 9/7/2019, while assisting Front Counter Orange Street, I received the attached courtesy report via
- 2 mail from Riverside Sheriff's Office.
- 3 Riverside County Sheriff File #MC192240003, has been attached to this report.
- 4 NFI.
- 5



Riverside Police Department

Officer Report

File Number:
190023109-081

Administrative Information

Subject:	1111 - OFFICER NEEDS BACK-UP/URGENT RESPONSE				
Date(s) and Time(s) of Occurrence Or Between:	9/6/2019 4:31:00 PM //				
Location Of Occurrence:	Box Springs Bldg / Eastridge Ave RIVERSIDE				
Date/Time Reported:	8/12/2019 5:38:06 PM	Day:	Friday		
Date Of Report:	9/9/2019 8:26:08 AM	Type Of Premises:			
NPC:		RD:	PG08	Beat:	3
Was There a Witness To The Crime?					
Can a Suspect Be Named Or Identified?		By Whom?			
Can a Suspect Vehicle Be Identified?		By Whom?			

Code Section Classification:

Records Section

Reporting Officer:	[REDACTED]		
115 Qualified:	No		
Send Copies Of This Report To:			
DOJ/NCIC Entered?		Name/ID	
DOJ/NCIC Cancelled?		Name/ID	
APR Sent?		Name/ID	
APB Sent?		Name/ID	

Public Narrative

Supervisor Approving

Approving Supervisor:	[REDACTED]
Date Reviewed:	9/9/2019 12:00:00 AM

Suspect Information

Code:		Name:	LUTHER, AARON NATHANIEL	Age:	49
Sex:	Male	Race:	[REDACTED]	[REDACTED]	[REDACTED]



Riverside Police Department

Officer Report

File Number:
190023109-081

Height:		Weight:	
Hair:		Eyes:	
Interviewed?		Parole?	Probation?
Parole Agent:		Probation Officer:	
CDC #		CII Number:	
Notes: DECEASED			

Suspect Scars, Marks and Tattoos

Scar, Mark, Tattoo	Scar, Mark, Tattoo Location	Description
--------------------	-----------------------------	-------------

Suspect Domestic Violence Information (If Applicable)

Emotional State:	Appearance:	Injuries:	Sobriety/Drug:

Suspect Driver's License Information:

Driver's License State:	California	Driver's License Country:	United States of America
-------------------------	------------	---------------------------	--------------------------

Suspect Vehicle Information:

Make	Model	Year	Color	License No.
------	-------	------	-------	-------------

Suspect Addresses:

Suspect Phones:

Phone Type	Phone Number
------------	--------------

Other Entities			



Riverside Police Department

Officer Report

File Number:
190023109-081

[REDACTED]

Witness Addresses:

[REDACTED]	[REDACTED]	[REDACTED]	[REDACTED]
[REDACTED]	[REDACTED]	[REDACTED]	[REDACTED]

Witness Phones:

[REDACTED]	[REDACTED]
[REDACTED]	[REDACTED]

Other Entities

[REDACTED]	[REDACTED]	[REDACTED]	[REDACTED]	[REDACTED]	[REDACTED]
[REDACTED]	[REDACTED]	[REDACTED]	[REDACTED]	[REDACTED]	[REDACTED]
[REDACTED]	[REDACTED]	[REDACTED]	[REDACTED]	[REDACTED]	[REDACTED]
[REDACTED]	[REDACTED]	[REDACTED]	[REDACTED]	[REDACTED]	[REDACTED]
[REDACTED]	[REDACTED]	[REDACTED]	[REDACTED]	[REDACTED]	[REDACTED]
[REDACTED]	[REDACTED]	[REDACTED]	[REDACTED]	[REDACTED]	[REDACTED]

Witness Addresses:

[REDACTED]	[REDACTED]	[REDACTED]	[REDACTED]
[REDACTED]	[REDACTED]	[REDACTED]	[REDACTED]

Witness Phones:

[REDACTED]	[REDACTED]
------------	------------

Evidence Information

Physical Evidence Present?		Physical Evidence Seized?	
Photographs Taken?		Photographer?	
Weapon Seized?		Weapon(s) Taken For Safety?	
Gang Related?		Sensitive Data?	
Fingerprint Search Made?		Fingerprints Obtained?	
Narcotics Seized?		Narcotics Field Tested?	
Audio Recording Available?		In Car Recording Available?	
Body Worn Camera Recording Available?			
Type of Weapon, Force, Or Device Used?			



Riverside Police Department

Officer Report

File Number:
190023109-081

Motive:			
Property Information			
Property:	Truck (not Stolen or Recovered)		
UCR Description			
IBR Type	37	UCR Type	V - Other Vehicle (not Stolen or Recovered)
Description:			
License No:			
Status:	Evidence (Seized)		
Uninhabited:			
Count:		Value:	
Property Owner:			
Manufacturer		Model	
Serial Number		Owner Applied Number	
Finish		Condition	
Color:			
Identifying Marks			
Recovered Date:		Disposition:	
Evidence Tag:			
Bicycle Information (If Applicable)			
Make:		Model:	
Speed:		Wheel Size:	
Vehicle Information (If Applicable)			
Type	22 - Pickups and Panels		
Make	GMC		
Model	Sonoma		
Year		Odometer Reading	
VIN			
Body Style	Pickup Truck	License State	California
License Plate Type:			
License Expiration Date:	08-2018		
Boat Information (If Applicable)			
Boat Name:			
Boat Type:			



Riverside Police Department

Officer Report

File Number:
190023109-081

HIN:	
Hull Shape	
Propulsion	
Boat Length	

Vehicle/Bicycle/Boat Color Information (If Applicable)

Vehicle Color Type	Vehicle Color
PR - Primary	WHI - White
Is Vehicle Stored?	Was the vehicle involved in a collision?
Was the collision reported?	Related Cases:

Drug Information (If Applicable)

Drug Type:	
Drug Quantity:	Drug Measure:

Narrative

1 On 09/06/2019, I called and spoke with [REDACTED] in response to a phone message received by
2 Sergeant [REDACTED] [REDACTED] asked how to get her husband's GMC SONOMA released from the tow
3 yard. She said she had been named as next-of-kin by the coroner's office. I told [REDACTED] the
4 process to retrieve the vehicle and asked that she respond to the Lincoln police facility to obtain the
5 vehicle release form if all paperwork was in order. I called the Riverside County Coroner's office and
6 confirmed that [REDACTED] was listed as next-of-kin for AARON LUTHER. At 1631 hours, after
7 reviewing all paperwork, I issued a "Tow Only" vehicle release form to [REDACTED] and to [REDACTED]
8 [REDACTED] I had both individuals sign the vehicle release form as [REDACTED] did not have a valid
9 driver license. [REDACTED] signed on the top line and [REDACTED] signed on the bottom line marked
10 "AGENT."
11



Riverside Police Department

Officer Report

File Number:
190023109-082

Administrative Information

Subject:	1111 - OFFICER NEEDS BACK-UP/URGENT RESPONSE				
Date(s) and Time(s) of Occurrence Or Between:	//				
Location Of Occurrence:	Box Springs Bldg / Eastridge Ave RIVERSIDE				
Date/Time Reported:	8/12/2019 5:38:06 PM	Day:			
Date Of Report:	9/9/2019 11:44:52 AM	Type Of Premises:			
NPC:		RD:	PG08	Beat:	3
Was There a Witness To The Crime?					
Can a Suspect Be Named Or Identified?		By Whom?			
Can a Suspect Vehicle Be Identified?		By Whom?			

Code Section Classification:

Records Section

Reporting Officer:	[REDACTED]		
115 Qualified:	No		
Send Copies Of This Report To:			
DOJ/NCIC Entered?		Name/ID	
DOJ/NCIC Cancelled?		Name/ID	
APR Sent?		Name/ID	
APB Sent?		Name/ID	

Public Narrative

Supervisor Approving

Approving Supervisor:	[REDACTED]
Date Reviewed:	9/19/2019 12:00:00 AM

Evidence Information

Physical Evidence Present?		Physical Evidence Seized?	
----------------------------	--	---------------------------	--



Riverside Police Department

Officer Report

File Number:
190023109-082

Photographs Taken?	Yes	Photographer?	[REDACTED]
Weapon Seized?		Weapon(s) Taken For Safety?	No
Gang Related?	Unknown	Sensitive Data?	Yes
Fingerprint Search Made?	No	Fingerprints Obtained?	N/A
Narcotics Seized?		Narcotics Field Tested?	No
Audio Recording Available?	No	In Car Recording Available?	No
Body Worn Camera Recording Available?	No		
Type of Weapon, Force, Or Device Used?			
Motive:			

Narrative

1 **Case Type:**

2 187 PC / Homicide on a Peace Officer

3 **Background:**

4 On 08/13/2019, at approximately 1830 hours, I received a call from Supervising Forensic
 5 Specialist [REDACTED] to respond to Sycamore Canyon Boulevard and Eucalyptus
 6 Avenue regarding a homicide investigation. I arrived on scene at approximately 1945 hours and
 7 attended a briefing from Supervising Forensic Specialist [REDACTED] who assigned me to
 8 assist the Riverside Treasure Hunters' metal detector search for expended cartridge cases and
 9 assist Detective [REDACTED] photograph evidence.

10 **Evidence Search:**

11 I met with [REDACTED] from Treasure Hunters to observe and assist with the search for
 12 expended cartridge cases in the brush just south and southeast of the black 2008 Honda Accord
 13 license plate [REDACTED] parked on Eastridge Avenue facing east. Utilizing their metal detectors
 14 we located (3) expended cartridge cases that were later collected by RPD Forensic Unit
 15 Personnel. See their reports for further information.

16 **Video/Photographs:**

17 On 08/13/2019, at the request of Detective [REDACTED], I took (154) digital photographs of
 18 Evidence Items #8-90, 94-98 while on scene.

19 On 08/14/2019 at approximately 0354 hours, I cleared the scene and responded to RPD
 20 Magnolia Station where I uploaded the photographs to a secure file format in the Digital
 21 Information Management System (DIMS).



Riverside Police Department Officer Report

File Number:
190023109-082

22 No further action was taken.

23

RIVERSIDE POLICE DEPARTMENT

Date Printed: 10/31/2022 8:28 AM	Case Report Number: 190023109-082	Page: 3 of 3	Ver. 1.3.3
-------------------------------------	--------------------------------------	-----------------	---------------



Riverside Police Department

Officer Report

File Number:
190023109-083

Administrative Information

Subject:	1111 - OFFICER NEEDS BACK-UP/URGENT RESPONSE				
Date(s) and Time(s) of Occurrence Or Between:	//				
Location Of Occurrence:	Box Springs Bldg / Eastridge Ave RIVERSIDE				
Date/Time Reported:	8/12/2019 5:38:06 PM	Day:			
Date Of Report:	9/9/2019 11:09:55 AM	Type Of Premises:			
NPC:		RD:	PG08	Beat:	3
Was There a Witness To The Crime?					
Can a Suspect Be Named Or Identified?		By Whom?			
Can a Suspect Vehicle Be Identified?		By Whom?			

Code Section Classification:

Records Section

Reporting Officer:	[REDACTED]		
115 Qualified:	No		
Send Copies Of This Report To:			
DOJ/NCIC Entered?		Name/ID	
DOJ/NCIC Cancelled?		Name/ID	
APR Sent?		Name/ID	
APB Sent?		Name/ID	

Public Narrative

Supervisor Approving

Approving Supervisor:	[REDACTED]
Date Reviewed:	9/13/2019 12:00:00 AM

Evidence Information

Physical Evidence Present?		Physical Evidence Seized?	
----------------------------	--	---------------------------	--



Riverside Police Department

Officer Report

File Number:
190023109-083

Photographs Taken?	Yes	Photographer?	██████████
Weapon Seized?		Weapon(s) Taken For Safety?	No
Gang Related?	No	Sensitive Data?	Unknown
Fingerprint Search Made?	Yes	Fingerprints Obtained?	No
Narcotics Seized?		Narcotics Field Tested?	No
Audio Recording Available?	No	In Car Recording Available?	No
Body Worn Camera Recording Available?	No		
Type of Weapon, Force, Or Device Used?			
Motive:			

Narrative

1 **Case Type:**

2 OIS / Officer Involved Shooting

3 187 PC / Homicide

4

5 **Service Requested:**

6 On 09/04/2019, I was requested by Det. ██████████ to photograph and process the below
7 listed evidence items for possible DNA and latent prints (electrical tape area).

8

9 OV016A- (2) Empty black 5.56 caliber magazines taped together with black electrical tape

10 OV020- (2) Empty black 5.56 caliber magazines taped together with black electrical tape.

11

12 At approximately 1353 hours, I removed the above listed evidence items from the secured
13 forensic unit vault for evidence processing.

14

15 **Photographs Taken:**

16 I photographed both items of evidence along with an area I swabbed for possible blood identified
17 as #1. A total of 15 photographs were downloaded to the Digital Information Management
18 System (DIMS).

19

20 **Latent Examination:**

21 At Det. ██████████ request, I only processed the wrapped exterior sides of the black electrical
22 tape located on each evidence item. I processed each item with sterile one time use fingerprint
23 brushes and clean bi-chromatic fingerprint powder. No sufficient quality latent prints were
24 observed or developed on the black electrical tape.

25

26 **Evidence Collection:**



Riverside Police Department

Officer Report

File Number:
190023109-083

27 I collected a sample swab of possible blood from item OV016A which is identified in
28 photographs as #1. The sample swab of possible blood was packaged and labeled OV016A-A. I
29 collected sample swabs of possible DNA from each evidence item which I packaged and labeled
30 OV016A-B and OV020A. I also collected a sample swab of sterile collection water which I
31 packaged and labeled REA02.

32

33 Evidence Disposition:

34 At approximately 1620 hours, I released OV016A, OV016A-A, OV016A-B, OV020, OV020A,
35 and REA02 to Magnolia Station property locker #37.

36

37 Please reference attached evidence log and property report for further information.

38

39 No further action was taken.

40

RIVERSIDE POLICE DEPARTMENT

Date Printed: 10/31/2022 8:43 AM	Case Report Number: 190023109-083	Page: 3 of 3	Ver. 1.3.3
-------------------------------------	--------------------------------------	-----------------	---------------



Riverside Police Department

Officer Report

File Number:
190023109-084

Administrative Information

Subject:		1111 - OFFICER NEEDS BACK-UP/URGENT RESPONSE			
Date(s) and Time(s) of Occurrence Or Between:		//			
Location Of Occurrence:		Box Springs Bldg / Eastridge Ave RIVERSIDE			
Date/Time Reported:	8/12/2019 5:38:06 PM	Day:			
Date Of Report:	9/10/2019 12:58:06 PM	Type Of Premises:			
NPC:		RD:	PG08	Beat:	3
Was There a Witness To The Crime?					
Can a Suspect Be Named Or Identified?		By Whom?			
Can a Suspect Vehicle Be Identified?		By Whom?			

Code Section Classification:

Records Section

Reporting Officer:	[REDACTED]				
115 Qualified:	No				
Send Copies Of This Report To:					
DOJ/NCIC Entered?		Name/ID			
DOJ/NCIC Cancelled?		Name/ID			
APR Sent?		Name/ID			
APB Sent?		Name/ID			

Public Narrative

Supervisor Approving

Approving Supervisor:	[REDACTED]				
Date Reviewed:	9/13/2019 12:00:00 AM				

Evidence Information

Physical Evidence Present?		Physical Evidence Seized?	
----------------------------	--	---------------------------	--



Riverside Police Department

Officer Report

File Number:
190023109-084

Photographs Taken?	Yes	Photographer?	██████████
Weapon Seized?		Weapon(s) Taken For Safety?	No
Gang Related?	No	Sensitive Data?	Unknown
Fingerprint Search Made?	No	Fingerprints Obtained?	N/A
Narcotics Seized?		Narcotics Field Tested?	No
Audio Recording Available?	No	In Car Recording Available?	No
Body Worn Camera Recording Available?	No		
Type of Weapon, Force, Or Device Used?			
Motive:			

Narrative

1 **Case Type:**

2 OIS / Officer Involved Shooting

3 187 PC / Homicide

4

5 **Service Requested:**

6 On 08/20/2019, at approximately 1130 hours, I received a request from Det. ██████████ to
7 photograph and process the below listed vehicle for possible blood, possible strike mark
8 documentation, and projectile recovery.

9

10 **White Kia Optima four door** ██████████)

11

12 **Photographs Taken:**

13 On 08/21/2019, at approximately 0902 hours, Det. ██████████ and I responded to the secured
14 Magnolia Station back parking lot where the vehicle was stored. I took photographs of the
15 exterior and interior of the vehicle which included possible strike marks A through A4, B, C, D,
16 E, and F and areas of possible blood.

17

18 A total of 171 photographs were downloaded to the secured Digital Information Management
19 System (DIMS).

20

21 **Latent Examination:**

22 Not requested.

23

24 **Evidence Collection:**

25 I observed multiple dry reddish-brown stains on the exterior and interior of the vehicle (driver
26 side). I tested one of these areas located on the exterior rear driver door for the presence of
27 possible blood using the presumptive test Phenolphthalein. The tested area was positive for the



Riverside Police Department

Officer Report

File Number:
190023109-084

28 presence of possible blood and was photographed. I then collected sample swabs of possible
29 blood from the exterior and interior driver side of the vehicle and interior front compartment
30 area. The sample swabs of possible blood were packaged and labeled KIA01 through KIA04. A
31 sample swab of sterile collection water was packaged and labeled KIA06. A metal fragment was
32 located on the rear driver floorboard. The metal fragment was collected, packaged, labeled
33 KIA05.

34
35 I checked areas where possible strike marks were present on the vehicle for any metal fragments
36 and/or projectiles, but no additional evidence was located. The damage to the vehicle from
37 searching these areas was documented in photographs. I completed processing the vehicle at
38 approximately 1200 hours, and secured all evidence items inside the forensic unit vault.

40 Evidence Disposition:

41 On 08/23/2019, at approximately 0835 hours, I removed evidence items KIA01 through KIA06
42 from the secured forensic unit vault. I released these evidence items to Magnolia Station property
43 locker #42 at approximately 1106 hours.

44
45 Please reference attached evidence log and property report for further information. No further
46 action was taken.

47

RIVERSIDE POLICE DEPARTMENT

Date Printed: 10/31/2022 8:44 AM	Case Report Number: 190023109-084	Page: 3 of 3	Ver. 1.3.3
-------------------------------------	--------------------------------------	-----------------	---------------



Riverside Police Department

Officer Report

File Number:
190023109-085

Administrative Information

Subject:		1111 - OFFICER NEEDS BACK-UP/URGENT RESPONSE			
Date(s) and Time(s) of Occurrence Or Between:		//			
Location Of Occurrence:		Box Springs Bldg / Eastridge Ave RIVERSIDE			
Date/Time Reported:	8/12/2019 5:38:06 PM	Day:			
Date Of Report:	9/10/2019 1:56:19 PM	Type Of Premises:			
NPC:		RD:	PG08	Beat:	3
Was There a Witness To The Crime?					
Can a Suspect Be Named Or Identified?		By Whom?			
Can a Suspect Vehicle Be Identified?		By Whom?			

Code Section Classification:

Records Section

Reporting Officer:	[REDACTED]				
115 Qualified:	No				
Send Copies Of This Report To:					
DOJ/NCIC Entered?		Name/ID			
DOJ/NCIC Cancelled?		Name/ID			
APR Sent?		Name/ID			
APB Sent?		Name/ID			

Public Narrative

Supervisor Approving

Approving Supervisor:	[REDACTED]				
Date Reviewed:	9/13/2019 12:00:00 AM				

Evidence Information

Physical Evidence Present?		Physical Evidence Seized?	
----------------------------	--	---------------------------	--



Riverside Police Department

Officer Report

File Number:
190023109-085

Photographs Taken?	Yes	Photographer?	██████████
Weapon Seized?		Weapon(s) Taken For Safety?	No
Gang Related?	No	Sensitive Data?	Unknown
Fingerprint Search Made?	No	Fingerprints Obtained?	N/A
Narcotics Seized?		Narcotics Field Tested?	No
Audio Recording Available?	No	In Car Recording Available?	No
Body Worn Camera Recording Available?	No		
Type of Weapon, Force, Or Device Used?			
Motive:			

Narrative

1 **Case Type:**

2 OIS / Officer Involved Shooting

3 187 PC / Homicide

4

5 **Service Requested:**

6 On 08/22/2019, at approximately 0800 hours, I was requested by Det. ██████████ to photograph
7 and process the below listed evidence item for possible blood and possible DNA collection.

8

9 **OV016-** Unknown make and caliber semi-auto assault rifle, unknown model and serial number
10 (possible blood)

11

12 At approximately 1400 hours, I removed OV016 and OV016A from the secured forensic unit
13 vault for evidence processing.

14

15 **Photographs Taken:**

16 I took 30 photographs of the firearm and magazines which included areas of possible blood
17 identified as #1 through #3 (firearm).

18

19 The photographs were downloaded to the secured Digital Information Management System
20 (DIMS).

21

22 **Latent Examination:**

23 Not requested.

24

25 **Evidence Collection:**

26 I collected sample swabs of possible blood from multiple areas on the firearm from the areas
27 identified in photographs as #1 through #3. These sample swabs of possible blood were



Riverside Police Department

Officer Report

File Number:
190023109-085

28 packaged and labeled OV016B through OV016D. I also collected sample swabs of possible
29 DNA from multiple areas on the firearm which were packaged and labeled OV016E through
30 OV016H. A sample swab of sterile collection water was packaged and labeled OV016I. At this
31 time, OV016A was only photographed and secured back inside the forensic unit vault at
32 approximately 1550 hours. I then secured OV016 inside the forensic unit vault at 1618 hours.

33

34 Evidence Disposition:

35 On 08/29/2019, at approximately 1425 hours, I removed OV016 from the secured forensic unit
36 vault. I released this item to Police Property Specialist [REDACTED] at approximately 1445 hours.

37

38 Please reference attached evidence log and property report for further information.

39

40 No further action was taken.

41

RIVERSIDE POLICE DEPARTMENT

Date Printed: 10/31/2022 8:55 AM	Case Report Number: 190023109-085	Page: 3 of 3	Ver. 1.3.3
-------------------------------------	--------------------------------------	-----------------	---------------



Riverside Police Department

Officer Report

File Number:
190023109-086

Administrative Information

Subject:	1111 - OFFICER NEEDS BACK-UP/URGENT RESPONSE				
Date(s) and Time(s) of Occurrence Or Between:	//				
Location Of Occurrence:	Box Springs Bldg / Eastridge Ave RIVERSIDE				
Date/Time Reported:	8/12/2019 5:38:06 PM	Day:			
Date Of Report:	9/10/2019 4:46:54 PM	Type Of Premises:			
NPC:		RD:	PG08	Beat:	3
Was There a Witness To The Crime?					
Can a Suspect Be Named Or Identified?			By Whom?		
Can a Suspect Vehicle Be Identified?			By Whom?		

Code Section Classification:

Records Section

Reporting Officer:	[REDACTED]		
115 Qualified:	No		
Send Copies Of This Report To:			
DOJ/NCIC Entered?		Name/ID	
DOJ/NCIC Cancelled?		Name/ID	
APR Sent?		Name/ID	
APB Sent?		Name/ID	

Public Narrative

Supervisor Approving

Approving Supervisor:	[REDACTED]
Date Reviewed:	9/11/2019 12:00:00 AM

Evidence Information

Physical Evidence Present?		Physical Evidence Seized?	
----------------------------	--	---------------------------	--



Riverside Police Department

Officer Report

File Number:
190023109-086

Photographs Taken?	Yes	Photographer?	██████████
Weapon Seized?		Weapon(s) Taken For Safety?	No
Gang Related?	No	Sensitive Data?	Unknown
Fingerprint Search Made?	No	Fingerprints Obtained?	N/A
Narcotics Seized?		Narcotics Field Tested?	No
Audio Recording Available?	No	In Car Recording Available?	No
Body Worn Camera Recording Available?	No		
Type of Weapon, Force, Or Device Used?			
Motive:			

Narrative

1
2 **Case Type:**
3 OIS / Officer Involved Shooting
4 187 PC / Homicide
5
6 **Service Requested:**
7 On 08/12/2019, at approximately 2245 hours, I was requested by Detective ██████████ to clear the
8 officer involved shooting scene and respond to Magnolia Station to photograph and chart
9 Riverside Police Officer (RPD) K. Feimer. Upon arrival at Magnolia Station, I was advised to
10 meet with Sergeant ██████████
11
12 At approximately 2303 hours, I arrived at Magnolia Station and met with Sgt. ██████████ who
13 assisted me with charting Ofc. Feimer.
14
15 **Photographs Taken:**
16 I took photographs of Ofc. Feimer and all his assigned duty equipment. A total of 37
17 photographs were downloaded to the secured Digital Information Management System (DIMS).
18
19 **Evidence Collection:**
20 No items of evidence were collected from Ofc. Feimer during the charting process.
21
22 **Evidence Disposition:**
23 I returned all duty equipment back to Ofc. Feimer once the charting process was completed.
24
25 Please reference attached firearm charting form for further information.
26
27 No further action was taken.



Riverside Police Department Officer Report

File Number:
190023109-086

28

RIVERSIDE POLICE DEPARTMENT

Date Printed: 10/31/2022 8:56 AM	Case Report Number: 190023109-086	Page: 3 of 3	Ver. 1.3.3
--	---	------------------------	----------------------



Riverside Police Department

Officer Report

File Number:
190023109-087

Administrative Information

Subject:	1111 - OFFICER NEEDS BACK-UP/URGENT RESPONSE				
Date(s) and Time(s) of Occurrence Or Between:	//				
Location Of Occurrence:	Box Springs Bldg / Eastridge Ave RIVERSIDE				
Date/Time Reported:	8/12/2019 5:38:06 PM	Day:			
Date Of Report:	9/11/2019 8:27:47 AM	Type Of Premises:			
NPC:		RD:	PG08	Beat:	3
Was There a Witness To The Crime?					
Can a Suspect Be Named Or Identified?		By Whom?			
Can a Suspect Vehicle Be Identified?		By Whom?			

Code Section Classification:

Records Section

Reporting Officer:	[REDACTED]		
115 Qualified:	No		
Send Copies Of This Report To:			
DOJ/NCIC Entered?		Name/ID	
DOJ/NCIC Cancelled?		Name/ID	
APR Sent?		Name/ID	
APB Sent?		Name/ID	

Public Narrative

Supervisor Approving

Approving Supervisor:	[REDACTED]
Date Reviewed:	10/31/2019 12:00:00 AM

Evidence Information

Physical Evidence Present?		Physical Evidence Seized?	
----------------------------	--	---------------------------	--



Riverside Police Department

Officer Report

File Number:
190023109-087

Photographs Taken?	Yes	Photographer?	██████████
Weapon Seized?		Weapon(s) Taken For Safety?	No
Gang Related?	No	Sensitive Data?	Unknown
Fingerprint Search Made?	No	Fingerprints Obtained?	N/A
Narcotics Seized?		Narcotics Field Tested?	No
Audio Recording Available?	No	In Car Recording Available?	No
Body Worn Camera Recording Available?	No		
Type of Weapon, Force, Or Device Used?			
Motive:			

Narrative

1
2 **Case Type:**
3 OIS / Officer Involved Shooting
4 187 PC / Homicide
5
6 **Service Requested:**
7 On 08/12/2019, at approximately 2340 hours, I was requested by Sgt. ██████████ to respond to the
8 California Highway Patrol (CHP) Station located at 8118 Lincoln Ave., and chart two CHP
9 Officers. Upon arrival, I was advised to meet with Det. ██████████.
10
11 At approximately 2350 hours, I arrived at the CHP Station and met with Det. ██████████ and CHP
12 personnel. I was assisted by Det. ██████████ during the charting process.
13
14 **Photographs Taken:**
15 On 08/13/2019, I took photographs of CHP Ofc. ██████████ and all his assigned duty
16 equipment.
17
18 I took photographs of CHP Ofc. ██████████ his injuries, his uniform, and his assigned duty
19 equipment.
20
21 I took photographs of CHP Ofc. ██████████ and his uniform.
22
23 A total of 112 photographs were downloaded to the secured Digital Information Management
24 System (DIMS).
25
26 On 08/15/2019, additional photographs were taken of evidence items SMI01 and KES01 prior to
27 property release. The photographs were downloaded to DIMS.



Riverside Police Department

Officer Report

File Number:
190023109-087

28

29 **Evidence Collection:**

30 At the request of Det. [REDACTED], I charted CHP Ofc. [REDACTED] duty weapon and two additional
31 firearm magazines. No property was collected from CHP Ofc. [REDACTED] during the charting
32 process. Once completed, I then charted CHP Ofc. [REDACTED] duty weapon and two additional
33 firearm magazines. I collected multiple evidence items which were packaged and labeled SMI02,
34 and SMI02A through SMI02C. I also received evidence item SMI01 which was packaged and
35 provided to me by CHP Ofc. [REDACTED]. After completing the charting process for CHP Ofc. [REDACTED] I
36 was directed by Det. [REDACTED] to only take photographs of CHP Ofc. [REDACTED] and to collect his
37 uniform. CHP personnel provided me with the clothing which I packaged and labeled KES01.

38

39 I cleared the CHP Station at approximately 0200 hours, and arrived at Magnolia Station at
40 approximately 0205 hours, where I secured all evidence items inside the forensic unit vault.

41

42 **Evidence Disposition:**

43 On 08/15/2019, at approximately 1200 hours, I removed evidence items SMI01 and KES01 from
44 the secured forensic unit vault. After photographs were taken of the items, I released them to
45 Magnolia Station property locker #38 at approximately 1540 hours.

46

47 On 08/21/2019, at approximately 1300 hours, I removed evidence items SMI02, SMI02A
48 through SMI02C from the secured forensic unit vault. These items were released to Magnolia
49 Station property locker #41 and #43 at approximately 1406 hours.

50

51 Please reference attached firearm charting forms, evidence log, and property report for further
52 information. No further action was taken.

53

RIVERSIDE POLICE DEPARTMENT



Riverside Police Department

Officer Report

File Number:
190023109-088

Administrative Information

Subject:	1111 - OFFICER NEEDS BACK-UP/URGENT RESPONSE				
Date(s) and Time(s) of Occurrence Or Between:	//				
Location Of Occurrence:	Box Springs Bldg / Eastridge Ave RIVERSIDE				
Date/Time Reported:	8/12/2019 5:38:06 PM	Day:			
Date Of Report:	9/11/2019 3:53:50 PM	Type Of Premises:			
NPC:		RD:	PG08	Beat:	3
Was There a Witness To The Crime?					
Can a Suspect Be Named Or Identified?		By Whom?			
Can a Suspect Vehicle Be Identified?		By Whom?			

Code Section Classification:

Records Section

Reporting Officer:	[REDACTED]		
115 Qualified:	Yes		
Send Copies Of This Report To:			
DOJ/NCIC Entered?		Name/ID	
DOJ/NCIC Cancelled?		Name/ID	
APR Sent?		Name/ID	
APB Sent?		Name/ID	

Public Narrative

Supervisor Approving

Approving Supervisor:	[REDACTED]
Date Reviewed:	9/12/2019 12:00:00 AM

Victim Information

PURSUANT TO CALIFORNIA PENAL CODE SECTION 293(a)/CONFIDENTIAL FORM(S) ATTACHED?:			
Code:		Name:	Feimer, Officer K.
Victim Type:	Law Enforcement Officer	Will the victim prosecute?	



Riverside Police Department

Officer Report

File Number:
190023109-088

Sex:		Race:		DOB:	
Height:		Weight:			
Hair:		Eyes:			
Notes:					

Victim Scars, Marks and Tattoos

Scar, Mark, Tattoo	Scar, Mark, Tattoo Location	Description
--------------------	-----------------------------	-------------

Victim Domestic Violence Information (If Applicable)

Emotional State:	Appearance:	Injuries:	Sobriety/Drug:
Victim Advised of Citizen's Arrest Rights?			
Victim Given "Alternatives To Domestic Violence" Card?			
Victim Given Agency Report Number?			
Victim Given Department Phone Number?			
Victim Advised Of Public Record/Privacy, 293(a) PC?			

Victim Vehicle Information:

Make	Model	Year	Color	License No.
------	-------	------	-------	-------------

Victim Injuries:

Injuries:	
If Treated For Injuries, By Whom?	
If Hospitalized, Where?	
Date/Time:	
Nature of Injuries:	
Injury Weapons:	

Victim Addresses:

Address Type	Address	City, State ZIP	County
Work	8181 Lincoln St	Riverside	Riverside

Victim Phones:

Phone Type	Phone Number
------------	--------------



Riverside Police Department

Officer Report

File Number:
190023109-088

Work	(951) 351-6099
------	----------------

Evidence Information

Physical Evidence Present?		Physical Evidence Seized?	
Photographs Taken?		Photographer?	
Weapon Seized?		Weapon(s) Taken For Safety?	
Gang Related?		Sensitive Data?	
Fingerprint Search Made?		Fingerprints Obtained?	
Narcotics Seized?		Narcotics Field Tested?	
Audio Recording Available?		In Car Recording Available?	
Body Worn Camera Recording Available?			
Type of Weapon, Force, Or Device Used?			
Motive:			

Narrative

1 Details:

2 I am a Detective assigned to the Robbery/Homicide unit. On 08/19/19, an
3 interview was conducted of Officer Feimer's officer involved shooting incident.
4 The interview was conducted by me and my partner Detective [REDACTED] (Co-
5 Case) at the Magnolia police station, inside the Conference Room.

6
7 The interview was audio recorded. After the interview, the audio recording was
8 downloaded into the departments PUMA audio recording system, and
9 accessible via Laserfiche for review.

10
11 ***The following is a synopsis of the conversation. It is not verbatim, nor
12 necessarily in order of conversation, and is organized for the purposes of
13 clarity. This report is not meant to take the place of the actual recording. It is
14 just a synopsis. For complete details refer to the recording of the interview. ***

15
16 Officer Feimer's Interview (08/19/19)

17 On 08-19-19 at approximately 0900 hours, Detective [REDACTED] and I
18 interviewed the involved Riverside Police Department Officer, Kevin Feimer.
19 Also present during the interview was Riverside County Deputy District



Riverside Police Department

Officer Report

File Number:
190023109-088

20 Attorney [REDACTED], Riverside County District Attorney's Office
21 Investigator [REDACTED], Riverside County District Attorney's Office
22 Investigator [REDACTED], and Officer Feimer's attorney [REDACTED].

23
24 I started the interview by advising Officer Feimer that this is a criminal
25 investigation that will be submitted to the District Attorney's Office for review.
26 I told him he did not have to speak with us and that he could not be disciplined
27 for not speaking with us. I asked Officer Feimer, other than the public safety
28 statement, has anyone ordered him to give a statement and he said, "No."
29 Officer Feimer was asked if he wished to speak to us at this time and he said,
30 "Yes."

31
32 Officer Feimer then provided the following information: date of birth
33 [REDACTED] badge #419, RPD# 1011, 20 years of service
34 (with the Riverside Police Department), currently assigned to the Lincoln
35 Station, 5'8", 200 lbs., date of hire 03-26-99, patrol start date was March 1999,
36 rank is Officer, two years of prior law-enforcement with Orange County Sheriff
37 Department, swing shift hours (1400-0000), call sign was "3R38", Unit #3849
38 (single-man unit), and the uniform he was wearing at the time of the incident
39 was his Riverside Police Department blue uniform; long sleeves (Class B).
40 Officer Feimer said his unit had video, and he was wearing a body camera
41 which was activated during the incident.

42
43 Officer Feimer was asked if he had a chance to review all known audio/video
44 recordings of the incident and he said, "Yes." He was asked what weapon he
45 used during the incident and how it was loaded or configured. He said he used
46 his Colt AR-15 rifle; which was loaded to capacity (twenty rounds in a twenty
47 round magazine.) Officer Feimer said he fired approximately three rounds and
48 was not injured during the incident.

49
50 Officer Feimer said he was up in the Mission Grove neighborhood, when he was
51 dispatched to an 11-11 for CHP with two officers down and the suspect still
52 shooting. Officer Feimer said he perceived that as an 11-99 (Officer Down) and
53 he started to drive Code 3 (emergency lights and sirens) to the call.

54
55 Officer Feimer said while en-route he was hearing updates via dispatch that
56 CHP Officers were still taking rounds, so he started thinking about officer
57 rescue tactics and how to engage the suspect. Officer Feimer said as he
58 approached Box Springs, he could see a white vehicle and couple police cars on
59 top of the bridge (left side.) Officer Feimer said he could see a subject standing
60 in front of the white truck holding a rifle.

61

Date Printed: 10/31/2022 8:59 AM	Case Report Number: 190023109-088	Page: 4 of 5	Ver. 1.3.3
-------------------------------------	--------------------------------------	-----------------	---------------



Riverside Police Department

Officer Report

File Number:
190023109-088

62 Officer Feimer said as he was pulling up he could see the subject walking
63 towards him, an unmarked Crown Victoria, and a Moreno Valley unit. Officer
64 Feimer said he could see a line of civilian cars on the right hand side of the
65 road so he stopped behind them and opened the door and could hear gunshots
66 going off. Officer Feimer said he heard a projectile fly past him, leading him to
67 believe the subject was shooting towards him.

68
69 Officer Feimer said he immediately went to the trunk of his unit and grabbed
70 his rifle. Officer Feimer said he started to move closer to the subject and close
71 the gap to get a better angle. Officer Feimer said as he passed the civilian cars
72 he saw people inside of them, and was fearful the suspect would either shoot
73 them or more police officers. Officer Feimer said he moved up to the second car
74 from the front of the line. Officer Feimer said he saw the subject turn towards
75 him holding the rifle and thought the suspect was going to shoot at him and/or
76 the civilians. Officer Feimer said he shot a round and the subject dropped to
77 the ground. Officer Feimer said the subject was still moving so he fired another
78 round at him.

79
80 Officer Feimer said he moved up to another vehicle which was closer and had a
81 better angle towards the subject. Officer Feimer said he got to the corner of the
82 SUV, and he saw the subject rolling over towards the white pick-up truck; and
83 got afraid the subject would fire underneath his pickup truck towards the CHP
84 officers. Officer Feimer said he took a third shot and the subject rolled back
85 onto his back and did not move again.

86
87 Officer Feimer said he watched the subject for a moment or two, and then told
88 the deputies around him to get the civilians out of the cars in the immediate
89 area. Officer Feimer said he also called for a black and white for a contact team
90 and a K-9 vehicle.

91
92 Officer Feimer said as this was going on he saw a contact team from the other
93 direction make contact with the subject, and go hands on. Officer Feimer said
94 at this point he told the officers around him to hold off due to a possible cross-
95 fire situation.

96
97 Officer Feimer said he started to walk up the hill towards the direction of the
98 subject, but was told by a Sheriff's Lieutenant he was the only suspect and
99 there was nobody else outstanding. Officer Feimer said he decided to turn back
100 around and made contact with Officer [REDACTED] and Sergeant [REDACTED] Officer
101 Feimer said Sergeant [REDACTED] pulled him aside, he provided his Public Safety
102 statement and he grounded the rifle in the trunk of his unit. Officer Feimer

Date Printed: 10/31/2022 8:59 AM	Case Report Number: 190023109-088	Page: 5 of 6	Ver. 1.3.3
-------------------------------------	--------------------------------------	-----------------	---------------



Riverside Police Department

Officer Report

File Number:
190023109-088

103 said he was later transported to the Magnolia station for the remainder of the
104 investigation.

105
106 I asked Officer Feimer if he remembered the color of the vehicle he first stopped
107 at and he thought it was a white colored vehicle.

108
109 I asked Officer Feimer when he took his first and/or second shot from the
110 vehicle, if he saw it hit the suspect? Officer Feimer said he remembered the
111 first round, when the suspect was facing him, the suspect immediately dropped
112 and rolled on the ground. Officer Feimer said he was approximately 75-100
113 yards away during the times he fired.

114
115 ***At this point of the interview I had Officer Feimer indicate on a set of
116 photographs of the crime scene, what he had just described to us during his
117 interview in regards to positioning and movements (the photos were later
118 collected and placed into a property locker at the Magnolia Station).***

119
120 After Officer Feimer reviewed the color photos of the scene, we took a short
121 break in the interview, and returned a short time later.

122
123 I asked Officer Feimer if he could explain his feelings/mindset of when he fired
124 his weapon. Officer Feimer said his fear was he (suspect) was going to shoot
125 and kill him, kill the civilians in the car, or additional officers. Officer Feimer
126 said at the time before his first shot he already knew the subject had fired and
127 hit two other officers. Officer Feimer said his mindset for the third shot was he
128 was in fear for the other officer's life, because he (Officer Feimer) thought the
129 suspect would fire more rounds from underneath his truck.

130
131 I asked Officer Feimer if at any time he saw an officer down during the
132 incident, and he said, "No, I could not see past the suspect and police cars."

133
134 Officer Feimer said he knew officers were down because of the radio traffic he
135 heard prior to arriving on-scene.

136
137 Detective ██████ asked Officer Feimer what kind of sighting system he had on
138 his rifle, and Officer Feimer said iron sights and a Red-Dot sighting system
139 (non-magnifying.) Officer Feimer said he used his iron sights for the shots, and
140 then turned on his Red-Dot sighting system after the third shot.

141
142 At the conclusion I asked Officer Feimer if he had anything to add or any
143 questions, and he said, "No."

144

Date Printed: 10/31/2022 8:59 AM	Case Report Number: 190023109-088	Page: 6 of 7	Ver. 1.3.3
-------------------------------------	--------------------------------------	-----------------	---------------



Riverside Police Department

Officer Report

File Number:
190023109-088

145 NFD
146

RIVERSIDE POLICE DEPARTMENT

Date Printed: 10/31/2022 8:59 AM	Case Report Number: 190023109-088	Page: 7 of 7	Ver. 1.3.3
-------------------------------------	--------------------------------------	-----------------	---------------



Riverside Police Department

Officer Report

File Number:
190023109-089

Administrative Information

Subject:	1111 - OFFICER NEEDS BACK-UP/URGENT RESPONSE				
Date(s) and Time(s) of Occurrence Or Between:	//				
Location Of Occurrence:	Box Springs Blvd / Eastridge Ave RIVERSIDE				
Date/Time Reported:	8/12/2019 5:38:06 PM	Day:			
Date Of Report:	9/11/2019 4:00:09 PM	Type Of Premises:			
NPC:		RD:	PG08	Beat:	3
Was There a Witness To The Crime?					
Can a Suspect Be Named Or Identified?		By Whom?			
Can a Suspect Vehicle Be Identified?		By Whom?			

Code Section Classification:

Records Section

Reporting Officer:	[REDACTED]		
115 Qualified:	Yes		
Send Copies Of This Report To:			
DOJ/NCIC Entered?		Name/ID	
DOJ/NCIC Cancelled?		Name/ID	
APR Sent?		Name/ID	
APB Sent?		Name/ID	

Public Narrative

Supervisor Approving

Approving Supervisor:	[REDACTED]
Date Reviewed:	9/20/2019 12:00:00 AM

Victim Information

PURSUANT TO CALIFORNIA PENAL CODE SECTION 293(a)/CONFIDENTIAL FORM(S) ATTACHED?:			
Code:		Name:	[REDACTED]
Victim Type:	Law Enforcement Officer	Will the victim prosecute?	



Riverside Police Department

Officer Report

File Number:
190023109-089

Sex:		Race:		DOB:	
Height:		Weight:			
Hair:		Eyes:			
Notes:					

Victim Scars, Marks and Tattoos

Scar, Mark, Tattoo	Scar, Mark, Tattoo Location	Description
--------------------	-----------------------------	-------------

Victim Domestic Violence Information (If Applicable)

Emotional State:	Appearance:	Injuries:	Sobriety/Drug:
Victim Advised of Citizen's Arrest Rights?			
Victim Given "Alternatives To Domestic Violence" Card?			
Victim Given Agency Report Number?			
Victim Given Department Phone Number?			
Victim Advised Of Public Record/Privacy, 293(a) PC?			

Victim Vehicle Information:

Make	Model	Year	Color	License No.
------	-------	------	-------	-------------

Victim Injuries:

Injuries:	
If Treated For Injuries, By Whom?	
If Hospitalized, Where?	
Date/Time:	
Nature of Injuries:	
Injury Weapons:	

Victim Addresses:

Address Type	Address	City, State ZIP	County
Work	22850 Calle San Juan Delos Lagos	Moreno Valley	Riverside

Victim Phones:



Riverside Police Department

Officer Report

File Number:
190023109-089

Evidence Information

Physical Evidence Present?		Physical Evidence Seized?	
Photographs Taken?		Photographer?	
Weapon Seized?		Weapon(s) Taken For Safety?	
Gang Related?		Sensitive Data?	
Fingerprint Search Made?		Fingerprints Obtained?	
Narcotics Seized?		Narcotics Field Tested?	
Audio Recording Available?		In Car Recording Available?	
Body Worn Camera Recording Available?			
Type of Weapon, Force, Or Device Used?			
Motive:			

Narrative

1 Details:
 2 I am a Detective assigned to the Robbery/Homicide unit. On 08/21/19, an
 3 interview was conducted of Riverside County Sheriff's Deputy, [REDACTED]
 4 officer involved shooting incident. The interview was conducted by me and my
 5 partner Detective [REDACTED] at the Magnolia police station, inside the Conference
 6 Room.
 7
 8 The interview was audio recorded. After the interview, the audio recording was
 9 downloaded into the departments PUMA audio recording system, and
 10 accessible via Laserfiche for review.
 11
 12 ***The following is a synopsis of the conversation. It is not verbatim, nor
 13 necessarily in order of conversation, and is organized for the purposes of
 14 clarity. This report is not meant to take the place of the actual recording. It is
 15 just a synopsis. For complete details refer to the recording of the interview. ***
 16
 17 [REDACTED] Interview (08/21/19)



Riverside Police Department

Officer Report

File Number:
190023109-089

18 On 08-21-19 at approximately 1425 hours, Detective [REDACTED] and I interviewed
19 the involved RSO Deputy, [REDACTED]. Also present during the interview
20 was Riverside County Deputy District Attorney [REDACTED] Riverside
21 County District Attorney's Office Investigator [REDACTED] Riverside County
22 District Attorney's Office Investigator [REDACTED], and Deputy [REDACTED]
23 attorney [REDACTED].

24
25 I started the interview by advising Deputy [REDACTED] that this is a criminal
26 investigation that will be submitted to the District Attorney's Office for review.
27 I told him he did not have to speak with us and that he could not be disciplined
28 for not speaking with us. I asked Deputy [REDACTED] other than the public safety
29 statement, has anyone ordered him to give a statement and he said, "No."
30 Deputy [REDACTED] was asked if he wished to speak to us at this time and he said,
31 "Yes."

32
33 Deputy [REDACTED] then provided the following information: [REDACTED]
34 [REDACTED] badge # 2085, county ID# 5376, almost 5
35 years of service (with the Riverside County Sheriff Department,) currently
36 assigned to the Moreno Valley Station, 5'06", 160 lbs., date of hire March 17th
37 2014, patrol start date was May 25th 2019, rank is Deputy Sheriff, watch one
38 (1700-0500), call sign was "1 Moreno 31", unit # 11246, riding with Deputy
39 [REDACTED] (Training Officer for phase 2,) and the uniform he was wearing at the
40 time of the incident was his short sleeve tan and green RSO uniform. Deputy
41 [REDACTED] said he was wearing a body worn camera, which was activated during
42 the incident.

43
44 Deputy [REDACTED] was asked if he had a chance to review all known audio/video
45 recordings of the incident and he said, "Yes." He was asked what weapon he
46 used during the incident and how was it loaded or configured. Deputy [REDACTED]
47 said he used his Glock 17 (9mm); which was loaded to capacity (17 round
48 extended magazine with three additional magazines) with one round
49 chambered. Deputy [REDACTED] said he fired three to four rounds, and was not
50 injured during the incident.

51
52 Deputy [REDACTED] said while he was in the area of Alessandro Blvd and Fredrick
53 St he heard the details of an 11-99 (Officer Down) over the radio. Deputy
54 [REDACTED] said he turned on his body worn camera and activated his lights and
55 siren. Deputy [REDACTED] said he heard over the radio the suspect was in
56 possession of an assault rifle and there was a CHP officer down. Deputy
57 [REDACTED] said as they got closer, there were cars all over the place, and he
58 pulled up behind the second CHP unit.

59

Date Printed: 10/31/2022 9:00 AM	Case Report Number: 190023109-089	Page: 4 of 5	Ver. 1.3.3
-------------------------------------	--------------------------------------	-----------------	---------------



Riverside Police Department

Officer Report

File Number:
190023109-089

60 Deputy ██████ said as they stopped the car, he saw the suspect holding the
61 rifle; shooting at them (him and Deputy ██████) and they quickly exited the
62 vehicle. Deputy ██████ said they ran to the back of their vehicle, and he took
63 position on the rear driver's side bumper.

64
65 Deputy ██████ said after a couple seconds, he again saw the suspect holding
66 the rifle running backyards towards his truck. Deputy ██████ said at that
67 time he fired two shots, but the first shot shattered the driver's side window of
68 their patrol vehicle.

69
70 Deputy ██████ said he saw the suspect again turn back towards them and he
71 ducked back behind their vehicle. Deputy ██████ said after a couple minutes
72 of gun fire from the suspect, his partner (Deputy ██████) fired 9-10 rounds
73 towards the suspect. Deputy ██████ said the next couple minutes, Deputy
74 ██████ and another officer moved forward to rescue the CHP officer and he was
75 going to provide cover fire.

76
77 Deputy ██████ said as the officers moved he stepped out to cover them, and
78 he saw the suspect's shoulder and face peek out from behind his truck. Deputy
79 ██████ said he fired a couple of rounds to protect the lives of his partners and
80 himself. Deputy ██████ said after those shots, the suspect moved back to the
81 hood of his truck, and out of sight.

82
83 Deputy ██████ said another officer helped out Deputy ██████ and got the
84 CHP officer out to the hospital. Deputy ██████ said as more officers arrived
85 on-scene, they formed a contact team to move tactically up to the suspect (who
86 was now down.) Deputy ██████ said as they approached the suspect, he
87 handcuffed him.

88
89 Deputy ██████ said the suspect was on his back so he rolled him over to his
90 stomach and placed him into custody. Deputy ██████ said he checked the
91 suspect's waistband for additional weapons and stood by until relieved by Cal-
92 Fire.

93
94 Deputy ██████ said his definition of "11-99" is shots fired, man down, an
95 officer who is in need of help. Deputy ██████ said he thought of that as he
96 drove to the scene.

97
98 Deputy ██████ said he exited the driver's side door of his unit, and heard
99 bullets hit his vehicle (very close), and thinking to himself he has to get to the
100 back of the unit and eliminate the threat.

101

Date Printed: 10/31/2022 9:00 AM	Case Report Number: 190023109-089	Page: 5 of 6	Ver. 1.3.3
--	---	------------------------	----------------------



Riverside Police Department

Officer Report

File Number:
190023109-089

102 Deputy ██████ said when his partner (Deputy ██████) was firing his volley of
103 shots, he (Deputy ██████) never had a visual on the suspect.

104
105 Deputy ██████ said when he was providing cover for the officer rescue portion
106 of the incident, he believed he fired one to two shots.

107
108 I had Deputy ██████ indicate on a set of photographs of the crime scene, what
109 he had just described to us during his interview in regards to positioning and
110 movements (the photos were later collected and placed into a property locker at
111 the Magnolia Station).

112
113 ***At this time we took a short break in the interview. ***

114
115 At the conclusion I asked Deputy ██████ if he had anything to add or if he
116 had any questions, and he said, "No."

117
118 NFD
119

RIVERSIDE POLICE DEPARTMENT



Riverside Police Department

Officer Report

File Number:
190023109-090

Administrative Information

Subject:		1111 - OFFICER NEEDS BACK-UP/URGENT RESPONSE			
Date(s) and Time(s) of Occurrence Or Between:		//			
Location Of Occurrence:		Box Springs Bldg / Eastridge Ave RIVERSIDE			
Date/Time Reported:	8/12/2019 5:38:06 PM	Day:			
Date Of Report:	9/11/2019 4:06:14 PM	Type Of Premises:			
NPC:		RD:	PG08	Beat:	3
Was There a Witness To The Crime?					
Can a Suspect Be Named Or Identified?		By Whom?			
Can a Suspect Vehicle Be Identified?		By Whom?			

Code Section Classification:

Records Section

Reporting Officer:	[REDACTED]				
115 Qualified:	Yes				
Send Copies Of This Report To:					
DOJ/NCIC Entered?		Name/ID			
DOJ/NCIC Cancelled?		Name/ID			
APR Sent?		Name/ID			
APB Sent?		Name/ID			

Public Narrative

Supervisor Approving

Approving Supervisor:	[REDACTED]				
Date Reviewed:	9/20/2019 12:00:00 AM				

Victim Information

PURSUANT TO CALIFORNIA PENAL CODE SECTION 293(a)/CONFIDENTIAL FORM(S) ATTACHED?:					
Code:		Name:	[REDACTED]		
Victim Type:	Law Enforcement Officer		Will the victim prosecute?		



Riverside Police Department

Officer Report

File Number:
190023109-090

Sex:		Race:		DOB:	
Height:		Weight:			
Hair:		Eyes:			
Notes:					

Victim Scars, Marks and Tattoos

Scar, Mark, Tattoo	Scar, Mark, Tattoo Location	Description
--------------------	-----------------------------	-------------

Victim Domestic Violence Information (If Applicable)

Emotional State:	Appearance:	Injuries:	Sobriety/Drug:
Victim Advised of Citizen's Arrest Rights?			
Victim Given "Alternatives To Domestic Violence" Card?			
Victim Given Agency Report Number?			
Victim Given Department Phone Number?			
Victim Advised Of Public Record/Privacy, 293(a) PC?			

Victim Vehicle Information:

Make	Model	Year	Color	License No.
------	-------	------	-------	-------------

Victim Injuries:

Injuries:	
If Treated For Injuries, By Whom?	
If Hospitalized, Where?	
Date/Time:	
Nature of Injuries:	
Injury Weapons:	

Victim Addresses:

Address Type	Address	City, State ZIP	County
Work	8118 Lincoln Ave	Riverside	Riverside

Victim Phones:

Phone Type	Phone Number
------------	--------------



Riverside Police Department

Officer Report

File Number:
190023109-090

Work	(951) 637-8000
------	----------------

Evidence Information

Physical Evidence Present?		Physical Evidence Seized?	
Photographs Taken?		Photographer?	
Weapon Seized?		Weapon(s) Taken For Safety?	
Gang Related?		Sensitive Data?	
Fingerprint Search Made?		Fingerprints Obtained?	
Narcotics Seized?		Narcotics Field Tested?	
Audio Recording Available?		In Car Recording Available?	
Body Worn Camera Recording Available?			
Type of Weapon, Force, Or Device Used?			
Motive:			

Narrative

1 Details:

2 I am a Detective assigned to the Robbery/Homicide unit. On 08/19/19, an
3 interview was conducted of CHP Officer [REDACTED] officer involved shooting
4 incident. The interview was conducted by me and my partner Detective
5 [REDACTED] (Co-Case) at the Magnolia police station, inside the Conference Room.

6
7 The interview was audio recorded. After the interview, the audio recording was
8 downloaded into the departments PUMA audio recording system, and
9 accessible via Laserfiche for review.

10
11 ***The following is a synopsis of the conversation. It is not verbatim, nor
12 necessarily in order of conversation, and is organized for the purposes of
13 clarity. This report is not meant to take the place of the actual recording. It is
14 just a synopsis. For complete details refer to the recording of the interview. ***

15
16 Officer Smith's Interview (08/19/19)

17 On 08-19-19 at approximately 1300 hours, Detective [REDACTED] and I
18 interviewed the involved CHP Officer, [REDACTED] Also present during the
19 interview was Riverside County Deputy District Attorney [REDACTED],



Riverside Police Department

Officer Report

File Number:
190023109-090

20 Riverside County District Attorney's Office Investigator [REDACTED], CHP
21 Officer [REDACTED] (area representative for Officer [REDACTED], Officer [REDACTED]
22 [REDACTED] (Smith's legal representation,) Sergeant [REDACTED] (CHP Critical
23 Incident Investigation Team,) and Sergeant [REDACTED] (CHP Critical
24 Incident Investigation Team.)

25
26 I started the interview by advising Officer [REDACTED] that this is a criminal
27 investigation that will be submitted to the District Attorney's Office for review.
28 I told him he did not have to speak with us and that he could not be disciplined
29 for not speaking with us. I asked Officer [REDACTED], other than the public safety
30 statement, has anyone ordered him to give a statement and he said, "No."
31 Officer [REDACTED] was asked if he wished to speak to us at that time and he said,
32 "Yes."

33
34 Officer [REDACTED] then provided the following information: [REDACTED]
35 [REDACTED], 6 years of service (with the California
36 Highway Patrol,) currently assigned to the Riverside Station, 5'11", 220 lbs.,
37 date of hire 04/29/2013, patrol start date was October 2013, rank is Officer,
38 military police for 12 years during his service with the United States Marine
39 Corps, works "B" watch (1300-2230), call sign was "74-40", single person unit,
40 and the uniform he was wearing at the time of the incident was his tan CHP
41 uniform (Class A.) Officer [REDACTED] said his unit had video, which was activated
42 during the incident.

43
44 Officer [REDACTED] was asked if he had a chance to review all known audio/video
45 recordings of the incident and he said, "No." (which was a personal preference.)
46 Officer [REDACTED] elected not to watch the video of the incident prior to his
47 interview. He was asked what weapon he used during the incident and how
48 was it loaded or configured. Officer [REDACTED] said he used his Smith & Wesson 40.
49 caliber pistol which was loaded to capacity (fifteen round magazine/3
50 magazines,) with one round chambered. Officer [REDACTED] said he fired
51 approximately 19 rounds and was injured during the incident. Officer [REDACTED]
52 sustained shrapnel injuries to both legs/calf/feet area and a bullet graze to his
53 left ankle and overall body soreness.

54
55 Officer [REDACTED] said he took a car that is usually assigned to someone else
56 because that officer was not working. Officer [REDACTED] said when he got into the
57 car, there was not an AR in the rifle lock. Officer [REDACTED] said he was at Ben
58 Clark Training Center and wrote some reports; along with Officer [REDACTED]
59 (beat partner.)

60



Riverside Police Department

Officer Report

File Number:
190023109-090

61 Officer ██████ said after writing some reports he left to go write some tickets
62 and work on his (ATS) Activity Tracking System. Officer ██████ said he heard a
63 call come out that did not sound right. Officer ██████ said he heard another
64 broadcast of officer down, shots fired.

65
66 Officer ██████ said he started driving northbound and continued to hear radio
67 traffic about Box Springs & Eastridge. Officer ██████ said he exited the off-ramp
68 and was looking for lights.

69
70 Officer ██████ said as he got closer he saw a white truck/SUV, the CHP
71 Explorer, and an officer who was down. Officer ██████ said as he was pulling up
72 to position his car, he saw somebody come from around the Explorer in front of
73 him and starts getting shot at.

74
75 Officer ██████ said he got out of the car and ran around the back of his car and
76 could see Officer ██████ sitting on the ground with his gun out. Officer ██████
77 said he could see Officer ██████ Explorer and could see an officer laying face
78 down.

79
80 Officer ██████ said the "bad guy" was in front of the officer laying down and
81 that's when he realized the officer must be dead.

82
83 Officer ██████ said he could tell Officer ██████ was alive because he was returning
84 fire every time the "bad guy" would shoot at them from the front of the
85 Explorer. Officer ██████ said he did not remember how many volleys of gunfire
86 he had with the suspect, but he (suspect) was using the Explorer as cover and
87 would pop out from the driver's side or passenger side to shoot at him.

88
89 Officer ██████ said he remembers seeing the rifle pointed at him and noticed it
90 had tactical rails and a big scope. Officer ██████ said he remembers saying to
91 himself, "he's shooting at me with an AR, he's shooting at me with an AR."
92 Officer ██████ said he was ducking down and returned fire. Officer ██████ said
93 his first round shattered the light bar of his unit.

94
95 Officer ██████ said he had a bad angle, but if he exposed himself he would get
96 shot. Officer ██████ said he remembers returning fire and looking behind him
97 and nobody was there. Officer ██████ said he felt alone, and how does he
98 (suspect) have so many bullets.

99
100 ***At this point of the interview, Officer ██████ gets emotional ***

101



Riverside Police Department

Officer Report

File Number:
190023109-090

102 Officer ██████ said the suspect would then shoot under the car, because he
103 could feel the pebbles from the asphalt hitting his pants and realized he was
104 trying to get Officer ██████ because Officer ██████ was still on the ground.

105
106 Officer ██████ said he would return fire and he (suspect) would maneuver
107 around and shoot back at him and take "pop" shots at Officer ██████. Officer
108 ██████ said he then heard Officer ██████ say, "fuck, fuck, fuck," and thought he
109 had to do something. Officer ██████ said when the suspect would fire, he would
110 fire back and try to get to Officer ██████.

111
112 Officer ██████ said he looked at Officer ██████ and could tell Officer ██████ was out
113 of ammo, so he told Officer ██████ over the radio what direction the suspect was
114 popping out from. Officer ██████ said he went up, grabbed Officer ██████ and
115 pulled him all the way back to his patrol car and he could see the suspect.

116
117 Officer ██████ said the suspect had advanced closer to them. Officer ██████ said
118 he felt like the suspect was up on his unit's push bar, shooting at them again
119 so he returned fire. Officer ██████ said he looked back and still nobody was
120 there to help.

121
122 Officer ██████ said a unit drove east bound past the incident, and the suspect
123 took a couple of shots at them and then another unit arrived behind him and
124 he tried to get Officer ██████ back farther.

125
126 Officer ██████ said he then holstered up, grabbed onto Officer ██████ with two
127 hands and pulled him back farther past officers returning fire towards the
128 suspect. Officer ██████ said he looked around looking for help to get Officer
129 ██████ to the hospital because the injury to his leg was bad. Officer ██████ said he
130 then saw two deputies arrive and they grabbed Officer ██████ and took him off to
131 the hospital.

132
133 Officer ██████ said he re-engaged in the gun fight and moved up with other
134 deputies with long-guns. Officer ██████ said he remembered hearing radio
135 traffic from the helicopter about the suspect being down with the rifle across
136 him. Officer ██████ said he had to grab onto a deputies vest to rest because he
137 was exhausted.

138
139 Officer ██████ said he had to approach the "bad guy" because he had to look
140 and find out if the "bad guy" was not going to hurt him. Officer ██████ said he
141 also had to see Officer Moye to see if he was OK. Officer ██████ said the suspect
142 had a swastika tattoo, blue underwear, and was still breathing.

143

Date Printed: 10/31/2022 9:01 AM	Case Report Number: 190023109-090	Page: 6 of 7	Ver. 1.3.3
-------------------------------------	--------------------------------------	-----------------	---------------



Riverside Police Department

Officer Report

File Number:
190023109-090

144 Officer [REDACTED] said as he approached the suspect, he put on latex gloves and
145 removed the gun and threw it into the bushes. Officer [REDACTED] said after that
146 (removing the gun) he does not remember anything else until the hospital.

147
148 Officer [REDACTED] said he received medical attention at the hospital and tried to see
149 Officer [REDACTED] but was not allowed to.

150
151 I asked Officer [REDACTED] if he remembered changing magazines during the
152 shootout and Officer [REDACTED] said he did some tactical reloads during the
153 exchange of gunfire. Officer [REDACTED] said he does not remember exactly when he
154 reloaded.

155
156 Officer [REDACTED] said he tried to advise Officer [REDACTED] over the radio of where the
157 suspect was at from time to time. Officer [REDACTED] said half the time he did not
158 know where the suspect was at. Officer [REDACTED] said the suspect would fire, he
159 (Officer [REDACTED] would fire back, and it was like a cat and mouse game.

160
161 Officer [REDACTED] said he was just trying to protect Officer [REDACTED] because he couldn't
162 see where the suspect was. Officer [REDACTED] said he was trying to protect the life
163 of Officer [REDACTED] and his own life. Officer [REDACTED] said if he (suspect) killed Officer
164 [REDACTED] and him, he would just kill the next person that would show up.

165
166 ***At this time of the interview, we took a break in the interview and returned a
167 short time later. ***

168
169 I had Officer [REDACTED] indicate on a set of photographs of the crime scene, what
170 he had just described to us during his interview in regards to positioning and
171 movements (the photos were later collected and placed into a property locker at
172 the Magnolia Station).

173
174 At the conclusion I asked Officer [REDACTED] if he had anything to add or if he had
175 any questions, and he said, "No."

176
177 NFD
178



Riverside Police Department

Officer Report

File Number:
190023109-091

Administrative Information

Subject:		1111 - OFFICER NEEDS BACK-UP/URGENT RESPONSE			
Date(s) and Time(s) of Occurrence Or Between:		//			
Location Of Occurrence:		Box Springs Bldg / Eastridge Ave RIVERSIDE			
Date/Time Reported:	8/12/2019 5:38:06 PM	Day:			
Date Of Report:	9/11/2019 4:10:34 PM	Type Of Premises:			
NPC:		RD:	PG08	Beat:	3
Was There a Witness To The Crime?					
Can a Suspect Be Named Or Identified?		By Whom?			
Can a Suspect Vehicle Be Identified?		By Whom?			

Code Section Classification:

Records Section

Reporting Officer:	[REDACTED]				
115 Qualified:	Yes				
Send Copies Of This Report To:					
DOJ/NCIC Entered?		Name/ID			
DOJ/NCIC Cancelled?		Name/ID			
APR Sent?		Name/ID			
APB Sent?		Name/ID			

Public Narrative

Supervisor Approving

Approving Supervisor:	[REDACTED]				
Date Reviewed:	9/20/2019 12:00:00 AM				

Victim Information

PURSUANT TO CALIFORNIA PENAL CODE SECTION 293(a)/CONFIDENTIAL FORM(S) ATTACHED?:					
Code:		Name:	[REDACTED]		
Victim Type:	Law Enforcement Officer		Will the victim prosecute?		



Riverside Police Department

Officer Report

File Number:
190023109-091

Sex:		Race:		DOB:	
Height:		Weight:			
Hair:		Eyes:			
Notes:					

Victim Scars, Marks and Tattoos

Scar, Mark, Tattoo	Scar, Mark, Tattoo Location	Description
--------------------	-----------------------------	-------------

Victim Domestic Violence Information (If Applicable)

Emotional State:	Appearance:	Injuries:	Sobriety/Drug:
Victim Advised of Citizen's Arrest Rights?			
Victim Given "Alternatives To Domestic Violence" Card?			
Victim Given Agency Report Number?			
Victim Given Department Phone Number?			
Victim Advised Of Public Record/Privacy, 293(a) PC?			

Victim Vehicle Information:

Make	Model	Year	Color	License No.
------	-------	------	-------	-------------

Victim Injuries:

Injuries:	
If Treated For Injuries, By Whom?	
If Hospitalized, Where?	
Date/Time:	
Nature of Injuries:	
Injury Weapons:	

Victim Addresses:

Address Type	Address	City, State ZIP	County
Work	8118 Lincoln Ave	Riverside	Riverside

Victim Phones:

Phone Type	Phone Number
------------	--------------



Riverside Police Department

Officer Report

File Number:
190023109-091

Work	(951) 637-8000
------	----------------

Evidence Information

Physical Evidence Present?		Physical Evidence Seized?	
Photographs Taken?		Photographer?	
Weapon Seized?		Weapon(s) Taken For Safety?	
Gang Related?		Sensitive Data?	
Fingerprint Search Made?		Fingerprints Obtained?	
Narcotics Seized?		Narcotics Field Tested?	
Audio Recording Available?		In Car Recording Available?	
Body Worn Camera Recording Available?			
Type of Weapon, Force, Or Device Used?			
Motive:			

Narrative

1 Details:

2 I am a Detective assigned to the Robbery/Homicide unit. On 08/21/19, an
3 interview was conducted of CHP Officer [REDACTED] officer involved shooting
4 incident. The interview was conducted by me and my partner Detective
5 [REDACTED] (Co-Case) at the Magnolia police station, inside the Conference Room.

6
7 The interview was audio recorded. After the interview, the audio recording was
8 downloaded into the departments PUMA audio recording system, and
9 accessible via Laserfiche for review.

10
11 ***The following is a synopsis of the conversation. It is not verbatim, nor
12 necessarily in order of conversation, and is organized for the purposes of
13 clarity. This report is not meant to take the place of the actual recording. It is
14 just a synopsis. For complete details refer to the recording of the interview. ***

15
16 Officer [REDACTED] Interview (08/21/19)

17 On 08-21-19 at approximately 1000 hours, Detective [REDACTED] and I
18 interviewed the involved CHP Officer, [REDACTED]. Also present during the
19 interview was Riverside County Deputy District Attorney [REDACTED],



Riverside Police Department

Officer Report

File Number:
190023109-091

20 Riverside County District Attorney's Office Investigator [REDACTED], Riverside
21 County District Attorney's Office Investigator [REDACTED] CHP Officer [REDACTED]
22 [REDACTED] (area representative for Officer [REDACTED]), Officer [REDACTED] ([REDACTED]
23 legal representation.)
24

25 I started the interview by advising Officer [REDACTED] that this is a criminal
26 investigation that will be submitted to the District Attorney's Office for review.
27 I told him he did not have to speak with us and that he could not be disciplined
28 for not speaking with us. I asked Officer [REDACTED], other than the public safety
29 statement, has anyone ordered him to give a statement and he said, "No."
30 Officer [REDACTED] was asked if he wished to speak to us at this time and he said,
31 "Yes."
32

33 Officer [REDACTED] then provided the following information: [REDACTED]
[REDACTED] 16 years of service (with the California
35 Highway Patrol, currently assigned to the Riverside Station, 5'10", 292 lbs.,
36 date of hire 12/2002, patrol start date was June 2003, rank is Officer, works
37 "B" watch (1300-2230), call sign was "74-41", unit # 1501660, single person
38 unit, and the uniform he was wearing at the time of the incident was his tan
39 CHP uniform short sleeve (Class A.) Officer [REDACTED] said his unit had video,
40 which was activated during the incident.
41

42 Officer [REDACTED] was asked if he had a chance to review all known audio/video
43 recordings of the incident and he said, "I did." He was asked what weapon he
44 used during the incident and how was it loaded or configured. Officer [REDACTED]
45 said he used his Sig 556 (.223 caliber); which was loaded to capacity (twenty
46 round detachable magazine) with one round chambered. Officer [REDACTED] said
47 he did not remember how many rounds he fired and was not injured during the
48 incident.
49

50 Officer [REDACTED] said he was at Ben Clark Training Center writing reports with
51 Officer [REDACTED] Officer [REDACTED] said he left the training center and he headed
52 south to his beat area. Officer [REDACTED] said while he was in the area of Brown
53 St. & Cajalco Rd. he heard the radio traffic of an officer down and shots fired.
54 Officer [REDACTED] said he immediately started north on the freeway, and
55 activated his code three lights and siren.
56

57 Officer [REDACTED] said he kept hearing the updates about an officer being down
58 with one not moving, and the suspect was still shooting. Officer [REDACTED] said
59 he released the rifle button and was able to arm himself with the rifle prior to
60 arriving on-scene.
61



Riverside Police Department

Officer Report

File Number:
190023109-091

62 Officer [REDACTED] said he was still unclear about the exact location of the
63 incident, but exited the freeway and approached from the east. Officer [REDACTED]
64 said he got off the freeway and shut off his siren, navigated through traffic, and
65 could see the incident across the street ahead of him.

66
67 Officer [REDACTED] said he could see the suspect shooting and decided to stay
68 along the opposite side of the street. Officer [REDACTED] said he saw a figure
69 standing at the front of a patrol car across the street but could not tell if he
70 was white or black.

71
72 Officer [REDACTED] said he got the suspect in his sights and fired. Officer
73 [REDACTED] said he remembered not seeing the rounds land around the patrol car
74 and wondered why. Officer [REDACTED] said he stopped and realized he was
75 looking over the carrying handle and not through the peep sights. Officer
76 [REDACTED] said he adjusted his sight picture and fired again, and saw the
77 suspect by the front of truck.

78
79 Officer [REDACTED] said he gained a good sight picture, and "lollipop" the suspect
80 with his front sight, and re-engaged the suspect. Officer [REDACTED] said he saw
81 the suspect go down, and thought the suspect could move again. Officer
82 [REDACTED] said he saw a concrete base to his left so he moved over there.

83
84 Officer [REDACTED] said from that angle, he heard a women yelling from a white
85 car and he was yelling at her to move out of the way because there was a gun
86 battle going on. Officer [REDACTED] said he realized the lady was bleeding from
87 her head and went over to her.

88
89 Officer [REDACTED] said he decided to deal with the lady in the car (suspect's wife)
90 and she told him her husband called her to pick him up. Officer [REDACTED] said
91 she had kids in the car and when she arrived the gun battle was already taking
92 place. Officer [REDACTED] said the suspect's wife's car took a round to the front
93 windshield, and she (the wife) got glass fragments to her forehead.

94
95 Officer [REDACTED] said he tried to get information about the suspect and why he
96 was shooting. Officer [REDACTED] said while talking with the wife, he saw the
97 helicopter land and take Officer Moye out to the hospital. Officer [REDACTED] said
98 he called over some AMR personnel to check out the wife and daughter. Officer
99 [REDACTED] said some deputies relieved him and he started walking around the
100 scene.

101
102 ****At this point of the interview, Officer [REDACTED] talks about hearing the gunfire*
103 *coming from the suspect. ****

Date Printed: 10/31/2022 9:02 AM	Case Report Number: 190023109-091	Page: 5 of 6	Ver. 1.3.3
-------------------------------------	--------------------------------------	-----------------	---------------



Riverside Police Department

Officer Report

File Number:
190023109-091

104
105 Officer ██████ said he remembered seeing the suspect facing the rest of the
106 officers moving toward them, and could hear gunfire. Officer ██████ said he
107 could hear the suspect's rifle and it seemed very loud. Officer ██████ said it
108 sounded louder than the calibers the officers were firing.

109
110 Officer ██████ said he could see the rifle in the suspect's hands while
111 standing by the hood of the truck. Officer ██████ said he wasn't sure if the
112 suspect even saw where he was at. Officer ██████ said he remembered
113 hearing metal hitting the ground, but it was his (Officer ██████) casings
114 hitting the ground.

115
116 Officer ██████ said he was thinking the suspect was advancing and attacking
117 his guys, not trying to get away. Officer ██████ said he was in fear for the
118 safety of his fellow officers and his own life.

119
120 Officer ██████ said he was a good distance away, approximately over a
121 hundred yards away from the suspect. Officer ██████ said at that distance it
122 was hard to keep him in sight, but he was able to keep the suspect's head on
123 his front sight and fired his rifle.

124
125 Officer ██████ said the suspect's wife told him the suspect's name was,
126 "Aaron Luther."

127
128 I had Officer ██████ indicate on a set of photographs of the crime scene, what
129 he had just described to us during his interview in regards to positioning and
130 movements (the photos were later collected and placed into a property locker at
131 the Magnolia Station).

132
133 ***During the review of the photos Officer ██████ explained why his unit was
134 not exactly where he originally stopped; because Officer ██████ was ordered
135 on-scene to grab a unit and go pick-up Officer Moye's wife and take her to the
136 hospital. Officer ██████ grabbed Officer ██████ unit and left the
137 scene***

138
139 At this time of the interview, we took a break in the interview and returned a
140 short time later.

141
142 At the conclusion I asked Officer ██████ if he had anything to add or if he
143 had any questions, and he said, "No."

144
145 NFD
146

Date Printed: 10/31/2022 9:02 AM	Case Report Number: 190023109-091	Page: 6 of 6	Ver. 1.3.3
-------------------------------------	--------------------------------------	-----------------	---------------



Riverside Police Department

Officer Report

File Number:
190023109-092

Administrative Information

Subject:	1111 - OFFICER NEEDS BACK-UP/URGENT RESPONSE				
Date(s) and Time(s) of Occurrence Or Between:	//				
Location Of Occurrence:	Box Springs Bldg / Eastridge Ave RIVERSIDE				
Date/Time Reported:	8/12/2019 5:38:06 PM	Day:			
Date Of Report:	9/13/2019 9:48:09 AM	Type Of Premises:			
NPC:		RD:	PG08	Beat:	3
Was There a Witness To The Crime?					
Can a Suspect Be Named Or Identified?		By Whom?			
Can a Suspect Vehicle Be Identified?		By Whom?			

Code Section Classification:

Records Section

Reporting Officer:	[REDACTED]		
115 Qualified:	No		
Send Copies Of This Report To:			
DOJ/NCIC Entered?		Name/ID	
DOJ/NCIC Cancelled?		Name/ID	
APR Sent?		Name/ID	
APB Sent?		Name/ID	

Public Narrative

Supervisor Approving

Approving Supervisor:	[REDACTED]
Date Reviewed:	11/9/2019 12:00:00 AM

Evidence Information

Physical Evidence Present?		Physical Evidence Seized?	
----------------------------	--	---------------------------	--



Riverside Police Department

Officer Report

File Number:
190023109-092

Photographs Taken?	Yes	Photographer?	██████████
Weapon Seized?		Weapon(s) Taken For Safety?	No
Gang Related?	No	Sensitive Data?	Unknown
Fingerprint Search Made?	No	Fingerprints Obtained?	N/A
Narcotics Seized?		Narcotics Field Tested?	No
Audio Recording Available?	No	In Car Recording Available?	No
Body Worn Camera Recording Available?	No		
Type of Weapon, Force, Or Device Used?			
Motive:			

Narrative

1 **Case Type:**

2 OIS / Officer Involved Shooting

3 187 PC / Homicide

4

5 **Service Requested:**

6 On 08/21/2019, at approximately 1430 hours, I was requested by Supervising Forensic Specialist
7 ██████████ to photograph and process the below listed vehicle.

8

9 **Ford Crown Victoria four door- Moreno Valley Police Unit (Riverside County Sheriff's**
10 **Department) 11-246 (LIC ██████████/CA Exempt)**

11

12 At this time Riverside Police Department (RPD) Ofc. ██████████ and I responded to the secured
13 Magnolia Station parking lot where the vehicle was stored to begin evidence processing.

14

15 **Photographs Taken:**

16 I took photographs of the exterior and interior of the police unit. I also took photographs of the
17 police unit shotgun (#89) that was secured in the firearm rack located between the front driver
18 and front passenger seats. The charting of this firearm was documented through photographs.

19

20 A total of 62 photographs were downloaded to the secured Digital Information Management
21 System (DIMS).

22

23 **Evidence Collection:**

24 I charted the police unit shotgun with the assistance of Ofc. ██████████. The shotgun and shotgun
25 shells were collected, packaged, and labeled MOR07. These items were secured inside the
26 forensic unit vault at approximately 1513 hours.

27



Riverside Police Department

Officer Report

File Number:
190023109-092

28 **Evidence Disposition:**

29 On 08/29/2019, at approximately 0750 hours, I removed evidence item MOR07 from the secured
30 forensic unit vault. I released MOR07 to Police Property Specialist [REDACTED] at approximately
31 0822 hours.

32
33 Please reference attached firearm charting form, evidence log, and property report for further
34 information.

35
36 No further action was taken.

37

RIVERSIDE POLICE DEPARTMENT

Date Printed: 10/31/2022 9:03 AM	Case Report Number: 190023109-092	Page: 3 of 3	Ver. 1.3.3
-------------------------------------	--------------------------------------	-----------------	---------------



Riverside Police Department

Officer Report

File Number:
190023109-093

Administrative Information

Subject:	1111 - OFFICER NEEDS BACK-UP/URGENT RESPONSE				
Date(s) and Time(s) of Occurrence Or Between:	8/12/2019 6:14:00 PM //				
Location Of Occurrence:	Box Springs Bldg / Eastridge Ave RIVERSIDE				
Date/Time Reported:	8/12/2019 5:38:06 PM	Day:	Monday		
Date Of Report:	9/19/2019 10:23:42 AM	Type Of Premises:			
NPC:		RD:	PG08	Beat:	3
Was There a Witness To The Crime?					
Can a Suspect Be Named Or Identified?		By Whom?			
Can a Suspect Vehicle Be Identified?		By Whom?			

Code Section Classification:

Records Section

Reporting Officer:	[REDACTED]		
115 Qualified:	No		
Send Copies Of This Report To:			
DOJ/NCIC Entered?		Name/ID	
DOJ/NCIC Cancelled?		Name/ID	
APR Sent?		Name/ID	
APB Sent?		Name/ID	

Public Narrative

Supervisor Approving

Approving Supervisor:	[REDACTED]
Date Reviewed:	9/26/2019 12:00:00 AM

Evidence Information

Physical Evidence Present?		Physical Evidence Seized?	
----------------------------	--	---------------------------	--



Riverside Police Department

Officer Report

File Number:
190023109-093

Photographs Taken?	Yes	Photographer?	[REDACTED]
Weapon Seized?		Weapon(s) Taken For Safety?	No
Gang Related?	Unknown	Sensitive Data?	Yes
Fingerprint Search Made?	No	Fingerprints Obtained?	N/A
Narcotics Seized?		Narcotics Field Tested?	No
Audio Recording Available?	No	In Car Recording Available?	No
Body Worn Camera Recording Available?	No		
Type of Weapon, Force, Or Device Used?			
Motive:			

Narrative

1 **Case Type:**

2 187 PC / Homicide

3 Officer Involved Shooting

4 **Background:**

5 On 8/12/2019, at approximately 1814 hours, I received a call from Sergeant [REDACTED] to
 6 respond to Eastridge Avenue and Box Springs Boulevard regarding an officer involved shooting.
 7 I called and requested additional support from Senior Forensic Specialists [REDACTED] and
 8 [REDACTED] and Detectives [REDACTED] and [REDACTED]. At approximately 1916
 9 hours, I arrived at the scene. I attended the scene incident brief and received information from
 10 Riverside Police Department, California Highway Patrol, and Riverside Sheriff Department
 11 personnel. At approximately 2051 hours, I cleared the scene and reported to the Moreno Valley
 12 Police Department (MVPD) Station (22850 Calle San Juan De Los Lagos, Moreno Valley) to
 13 photograph, chart, and collected evidence from (5) MVPD Riverside Sheriff Deputies.

14 **Photographs:**

15 I took (261) digital photographs of (5) Riverside Sheriff Department deputies and their weapon
 16 chartings at the MVPD Station, which were later downloaded to a secure file format in the
 17 Digital Information Management System (DIMS).

18 **Deputy Processing:**

19 At approximately 2100 hours, I arrived at the MVPD station. I contacted Detective [REDACTED]
 [REDACTED], who identified what photographs and evidence needed to be collected.



Riverside Police Department

Officer Report

File Number:
190023109-093

21 I took photographs of Deputy [REDACTED], possible blood on his uniform and hands,
22 duty weapon, and spare magazines. I collected a possible blood sample from each of the palms
23 of his hands (Evidence Items #MCHAP01, MCHAP02) and buccal DNA exemplar samples from
24 his mouth (Evidence Item #MCHAP03). I charted Deputy [REDACTED] duty weapon and spare
25 magazines. I released the duty weapon and spare magazines to Deputy [REDACTED] after charting
26 completion.

27 I photographed Deputy Corporal [REDACTED], possible blood on his uniform and right
28 forearm, possible injury to his left elbow, duty weapon, spare magazines, and loose cartridge in
29 his pocket. I collected a possible blood sample from his right forearm (Evidence Item #JV01)
30 and buccal DNA exemplar samples from his mouth (Evidence Item #JV02). I charted Deputy
31 [REDACTED] duty weapon and spare magazines. I released the duty weapon and spare magazines to
32 Deputy [REDACTED] after charting completion. I collected a sterile collection water sample
33 (Evidence Item #WS-1).

34 I photographed Deputy [REDACTED], possible blood on his uniform, left elbow and right
35 hand, his duty weapon, spare duty weapon magazines, back-up weapon, and spare back-up
36 weapon magazine. I collected possible blood samples from his right ring finger, left uniform
37 shirt pocket, and right boot toe (Evidence Items #BE01-BE03). I charted Deputy [REDACTED] duty
38 weapon, spare duty weapon magazines, back-up weapon, and spare back-up weapon magazine. I
39 collected Deputy [REDACTED] duty weapon (Evidence Items #BE04, BE04-A, BE04-B). I released
40 the duty weapon spare magazines, back-up weapon, and back-up weapon spare magazines to
41 Deputy [REDACTED] after charting completion.

42 I photographed Deputy [REDACTED] his duty weapon, and spare magazine. I collected
43 Deputy [REDACTED] duty weapon (Evidence Items #MCHAV01, MCHAV01-A, and MCHAV01-
44 B). I released the duty weapon spare magazine to Deputy [REDACTED] after charting completion.

45 I photographed Deputy [REDACTED] his duty weapon, and spare magazines. I collected
46 Deputy [REDACTED] duty weapon (Evidence Items #DG01, DG01-A, DG01-B). I released the duty
47 weapon spare magazines to Deputy [REDACTED] after charting completion.

48 I collected a sterile collection water sample (Evidence Item #WS-2). Detective [REDACTED] assisted
49 me in the documentation of the deputies and evidence collected. Refer to the evidence logs and
50 weapon charting forms.

51 On 8/13/2019, at approximately 0108 hours, I cleared the MVPD station and transported all
52 evidence items to the Magnolia Station. I secured all evidence items in the Forensics Unit
53 Evidence Vault.

54 On 8/19/2019, from approximately 1030-1720 hours, I removed all evidence items from the
55 secured Forensics Unit Evidence Vault for packaging.

56 Evidence Collection/Measurements:

57 Refer to the evidence logs and weapon charting forms.

Date Printed: 10/31/2022 9:04 AM	Case Report Number: 190023109-093	Page: 3 of 4	Ver. 1.3.3
-------------------------------------	--------------------------------------	-----------------	---------------



Riverside Police Department

Officer Report

File Number:
190023109-093

58 **Evidence Disposition:**

59 On 8/13/2019, at approximately 0108 hours, I transported all evidence items to the Magnolia
60 Police Station. At approximately 0249 hours, I secured all evidence items in the secured
61 Forensics Unit Evidence Vault.

62 On 8/19/2019, at approximately 1030 hours, I removed all evidence items from the secured
63 Evidence Vault for packaging. I secured the items in the vault after processing, at approximately
64 1720 hours.

65 On 8/21/2019, at approximately 1412 hours, I removed Items #BE01 through BE04-B, DG01
66 through DG01-B, JV01, JV02, MCHAP01-MCHAP03, MCHAV01 through MCHAV01-B, WS-
67 1, and WS-2 to Magnolia Station Police Property Specialist [REDACTED]. No further action
68 was taken.

69

RIVERSIDE POLICE DEPARTMENT

Date Printed: 10/31/2022 9:04 AM	Case Report Number: 190023109-093	Page: 4 of 4	Ver. 1.3.3
-------------------------------------	--------------------------------------	-----------------	---------------



Riverside Police Department

Officer Report

File Number:
190023109-094

Administrative Information

Subject:	1111 - OFFICER NEEDS BACK-UP/URGENT RESPONSE				
Date(s) and Time(s) of Occurrence Or Between:	//				
Location Of Occurrence:	Box Springs Bldg / Eastridge Ave RIVERSIDE				
Date/Time Reported:	8/12/2019 5:38:06 PM	Day:			
Date Of Report:	9/25/2019 8:32:24 AM	Type Of Premises:			
NPC:		RD:	PG08	Beat:	3
Was There a Witness To The Crime?					
Can a Suspect Be Named Or Identified?		By Whom?			
Can a Suspect Vehicle Be Identified?		By Whom?			

Code Section Classification:

Records Section

Reporting Officer:	[REDACTED]		
115 Qualified:	No		
Send Copies Of This Report To:			
DOJ/NCIC Entered?		Name/ID	
DOJ/NCIC Cancelled?		Name/ID	
APR Sent?		Name/ID	
APB Sent?		Name/ID	

Public Narrative

Supervisor Approving

Approving Supervisor:	[REDACTED]
Date Reviewed:	3/24/2020 12:00:00 AM

Evidence Information

Physical Evidence Present?		Physical Evidence Seized?	
----------------------------	--	---------------------------	--



Riverside Police Department

Officer Report

File Number:
190023109-094

Photographs Taken?		Photographer?	
Weapon Seized?		Weapon(s) Taken For Safety?	
Gang Related?		Sensitive Data?	
Fingerprint Search Made?		Fingerprints Obtained?	
Narcotics Seized?		Narcotics Field Tested?	
Audio Recording Available?		In Car Recording Available?	
Body Worn Camera Recording Available?			
Type of Weapon, Force, Or Device Used?			
Motive:			

Narrative

- 1 On 09/20/19 at approximately 1430 hours, I responded to Moreno Valley Police Department to
- 2 retrieve (18) items that were collected from the scene. On 09/25/19 at approximately 0730 hours, I
- 3 booked the items into the Property Unit at the RPD Magnolia Station as evidence Items # CES001-
- 4 CES018.
- 5
- 6 No further.
- 7



Riverside Police Department

Officer Report

File Number:
190023109-096

Administrative Information

Subject:	1111 - OFFICER NEEDS BACK-UP/URGENT RESPONSE				
Date(s) and Time(s) of Occurrence Or Between:	8/15/2019 12:32:00 PM //				
Location Of Occurrence:	Box Springs Bldg / Eastridge Ave RIVERSIDE				
Date/Time Reported:	8/12/2019 5:38:06 PM	Day:	Thursday		
Date Of Report:	9/26/2019 4:29:25 PM	Type Of Premises:			
NPC:		RD:	PG08	Beat:	3
Was There a Witness To The Crime?					
Can a Suspect Be Named Or Identified?		By Whom?			
Can a Suspect Vehicle Be Identified?		By Whom?			

Code Section Classification:

Records Section

Reporting Officer:	[REDACTED]		
115 Qualified:	No		
Send Copies Of This Report To:			
DOJ/NCIC Entered?		Name/ID	
DOJ/NCIC Cancelled?		Name/ID	
APR Sent?		Name/ID	
APB Sent?		Name/ID	

Public Narrative

On 08/15/2019, at approximately 1232 hours, I received an assignment from Supervising Forensic Specialist [REDACTED] to photograph and recover projectile evidence from a vehicle at the Magnolia Police Station regarding a homicide investigation.

Supervisor Approving

Approving Supervisor:	[REDACTED]
Date Reviewed:	9/26/2019 12:00:00 AM

Evidence Information



Riverside Police Department

Officer Report

File Number:
190023109-096

Physical Evidence Present?		Physical Evidence Seized?	
Photographs Taken?	Yes	Photographer?	[REDACTED]
Weapon Seized?		Weapon(s) Taken For Safety?	No
Gang Related?	No	Sensitive Data?	No
Fingerprint Search Made?	No	Fingerprints Obtained?	N/A
Narcotics Seized?		Narcotics Field Tested?	No
Audio Recording Available?	No	In Car Recording Available?	No
Body Worn Camera Recording Available?	No		
Type of Weapon, Force, Or Device Used?			
Motive:			

Narrative

1 **Case Type:**

2
3 187 PC – Homicide on a Peace Officer

4 **Background:**

5 On 08/15/2019, at approximately 1232 hours, I received an assignment from Supervising Forensic Specialist [REDACTED] to
6 photograph and recover projectile evidence from a vehicle at the Magnolia Police Station regarding a homicide investigation. I
7 started at approximately 1232hrs and finished at approximately 1453hrs.

8 **Photographs:**

9 I took (90) digital photographs of a silver Toyota Corolla, CA [REDACTED], which I later downloaded
10 to a secure file format in the Digital Information Management System (DIMS).

11 **Vehicle Examination:**

12 At approximately 1232 hours, I arrived at the vehicle. I conducted a search for projectiles and projectile strike marks. I observed
13 possible strike marks to the exterior front windshield (Strike Mark "A"), interior front windshield (Strike Mark "A1"), front of
14 rear middle seat headrest (Strike Mark "A2"), plastic panel behind rear seat headrests (Strike Mark "A3"), interior brake light
15 (Strike Mark "A4") and a possible strike mark to the rear window. I located (1) projectile wedged between the rear plastic panel
16 and the rear window. I labeled, photographed and collected the projectile as Evidence Item #DMB001. Refer to the attached
17 property report. Photography of the vehicle was assisted by Supervising Forensic Specialist [REDACTED]. At approximately
18 1453 hours, I completed my assignment and cleared the vehicle.

19 **Evidence Collection/Measurements:**

20 DMB001 - (1) Jacketed Projectile - between the rear plastic panel and the rear window near the interior brake light.

21 **Evidence Disposition:**

[REDACTED] On 08/15/2019, at approximately 1536 hours, I released Evidence Item #DMB001 to Police Property Specialist [REDACTED]
[REDACTED] at the Magnolia Station Property counter. No further action was taken.



Riverside Police Department Officer Report

File Number:
190023109-096

24

RIVERSIDE POLICE DEPARTMENT

Date Printed: 10/31/2022 9:07 AM	Case Report Number: 190023109-096	Page: 3 of 3	Ver. 1.3.3
-------------------------------------	--------------------------------------	-----------------	---------------



Riverside Police Department

Officer Report

File Number:
190023109-097

Administrative Information

Subject:	1111 - OFFICER NEEDS BACK-UP/URGENT RESPONSE				
Date(s) and Time(s) of Occurrence Or Between:	//				
Location Of Occurrence:	Box Springs Bldg / Eastridge Ave RIVERSIDE				
Date/Time Reported:	8/12/2019 5:38:06 PM	Day:			
Date Of Report:	9/26/2019 4:51:58 PM	Type Of Premises:			
NPC:		RD:	PG08	Beat:	3
Was There a Witness To The Crime?					
Can a Suspect Be Named Or Identified?			By Whom?		
Can a Suspect Vehicle Be Identified?			By Whom?		

Code Section Classification:

Records Section

Reporting Officer:	[REDACTED]		
115 Qualified:	No		
Send Copies Of This Report To:			
DOJ/NCIC Entered?		Name/ID	
DOJ/NCIC Cancelled?		Name/ID	
APR Sent?		Name/ID	
APB Sent?		Name/ID	

Public Narrative

On 08/15/2019, at approximately 0845 hours, I received an assignment from Supervising Forensic Specialist [REDACTED] to photograph and recover projectile evidence from a vehicle at the Magnolia Police Station regarding a homicide investigation.

Supervisor Approving

Approving Supervisor:	[REDACTED]
Date Reviewed:	10/3/2019 12:00:00 AM

Evidence Information



Riverside Police Department

Officer Report

File Number:
190023109-097

Physical Evidence Present?		Physical Evidence Seized?	
Photographs Taken?	Yes	Photographer?	[REDACTED]
Weapon Seized?		Weapon(s) Taken For Safety?	No
Gang Related?	No	Sensitive Data?	No
Fingerprint Search Made?	No	Fingerprints Obtained?	N/A
Narcotics Seized?		Narcotics Field Tested?	No
Audio Recording Available?	No	In Car Recording Available?	No
Body Worn Camera Recording Available?	No		
Type of Weapon, Force, Or Device Used?			
Motive:			

Narrative

1 **Case Type:**

2
3 187 PC – Homicide on a Peace Officer

4 **Background:**

5 On 08/15/2019, at approximately 0845 hours, I received an assignment from Supervising Forensic Specialist [REDACTED] to
6 photograph and recover projectile evidence from a vehicle at the Magnolia Police Station regarding a homicide investigation. I
7 started at approximately 0845 hours and finished at approximately 1148 hours.

8 **Photographs:**

9 I took (77) digital photographs of a white 2014 Ford F150 Truck, [REDACTED], which I later downloaded to a
10 secure file format in the Digital Information Management System (DIMS).

11 **Vehicle Examination:**

12 At approximately 0845 hours, I arrived at the vehicle. I conducted a search for projectiles and projectile strike marks. I observed
13 possible strike marks to the driver side rear passenger door window (Strike Mark "A"), to the plastic window frame of the
14 driver's door near the mirror (Strike Mark "B") and to the plastic window frame (Strike Mark "B2"), the lower portion of driver
15 side rear passenger door (Strike Mark "C"), the area near the gas tank lid (Strike Mark "D") and the driver side bed/quarter panel
16 (Strike Mark "E"). I labeled and photographed the possible strike marks. Photography of the vehicle was assisted by Supervising
17 Forensic Specialist [REDACTED]. At approximately 1148 hours, I completed my assignment and cleared the vehicle.

18 **Evidence Collection/Measurements:**

19 No physical evidence was collected from the truck.

20



Riverside Police Department

Officer Report

File Number:
190023109-098

Administrative Information

Subject:	1111 - OFFICER NEEDS BACK-UP/URGENT RESPONSE				
Date(s) and Time(s) of Occurrence Or Between:	//				
Location Of Occurrence:	Box Springs Bldg / Eastridge Ave RIVERSIDE				
Date/Time Reported:	8/12/2019 5:38:06 PM	Day:			
Date Of Report:	10/3/2019 11:10:23 AM	Type Of Premises:			
NPC:		RD:	PG08	Beat:	3
Was There a Witness To The Crime?					
Can a Suspect Be Named Or Identified?		By Whom?			
Can a Suspect Vehicle Be Identified?		By Whom?			

Code Section Classification:

Records Section

Reporting Officer:	[REDACTED]		
115 Qualified:	Yes		
Send Copies Of This Report To:			
DOJ/NCIC Entered?		Name/ID	
DOJ/NCIC Cancelled?		Name/ID	
APR Sent?		Name/ID	
APB Sent?		Name/ID	

Public Narrative

Supervisor Approving

Approving Supervisor:	[REDACTED]
Date Reviewed:	10/4/2019 12:00:00 AM

Other Entities

Name:	[REDACTED]
-------	------------



Riverside Police Department

Officer Report

File Number:
190023109-098

Entity Type:	[REDACTED]	Code:	
Sex:	[REDACTED]	Race:	
DOB:			
Height:		Weight:	
Hair:		Eyes:	
Notes:			

Witness Addresses:

Address Type	Address	City, State ZIP	County
[REDACTED]	[REDACTED]	[REDACTED]	[REDACTED]

Witness Phones:

[REDACTED]	[REDACTED]
[REDACTED]	[REDACTED]

Evidence Information

Physical Evidence Present?		Physical Evidence Seized?	
Photographs Taken?		Photographer?	
Weapon Seized?		Weapon(s) Taken For Safety?	
Gang Related?		Sensitive Data?	
Fingerprint Search Made?		Fingerprints Obtained?	
Narcotics Seized?		Narcotics Field Tested?	
Audio Recording Available?		In Car Recording Available?	
Body Worn Camera Recording Available?			
Type of Weapon, Force, Or Device Used?			
Motive:			

Narrative

- 1 On 10/03/2019 at approximately 1023 hours, Riverside County Sheriff Service Officer [REDACTED]
- 2 responded to the Magnolia Police station and took possession of the following evidence items:
- 3
- 4 DG01 (Deputy [REDACTED] firearm)
- 5 MCHAV01 (Deputy [REDACTED] firearm)
- 6 BE04 (Deputy Trainee [REDACTED] firearm)
- 7
- 8 NFD
- 9



Riverside Police Department

Officer Report

File Number:
190023109-100

Administrative Information

Subject:		1111 - OFFICER NEEDS BACK-UP/URGENT RESPONSE			
Date(s) and Time(s) of Occurrence Or Between:		8/20/2019 9:30:00 AM //			
Location Of Occurrence:		Box Springs Bldg / Eastridge Ave RIVERSIDE			
Date/Time Reported:	8/12/2019 5:38:06 PM	Day:	Tuesday		
Date Of Report:	10/5/2019 10:30:10 AM	Type Of Premises:			
NPC:		RD:	PG08	Beat:	3
Was There a Witness To The Crime?					
Can a Suspect Be Named Or Identified?		By Whom?			
Can a Suspect Vehicle Be Identified?		By Whom?			

Code Section Classification:

Records Section

Reporting Officer:	[REDACTED]				
115 Qualified:	No				
Send Copies Of This Report To:					
DOJ/NCIC Entered?		Name/ID			
DOJ/NCIC Cancelled?		Name/ID			
APR Sent?		Name/ID			
APB Sent?		Name/ID			

Public Narrative

Supervisor Approving

Approving Supervisor:	[REDACTED]				
Date Reviewed:	10/8/2019 12:00:00 AM				

Evidence Information

Physical Evidence Present?		Physical Evidence Seized?	
----------------------------	--	---------------------------	--



Riverside Police Department

Officer Report

File Number:
190023109-100

Photographs Taken?	Yes	Photographer?	[REDACTED]
Weapon Seized?		Weapon(s) Taken For Safety?	No
Gang Related?	Unknown	Sensitive Data?	Yes
Fingerprint Search Made?	No	Fingerprints Obtained?	N/A
Narcotics Seized?		Narcotics Field Tested?	No
Audio Recording Available?	No	In Car Recording Available?	No
Body Worn Camera Recording Available?	No		
Type of Weapon, Force, Or Device Used?			
Motive:			

Narrative

1 **Case Type:**

2 187 P.C. / Homicide on a Peace Officer

3 **Background:**

4 On 8/19/2019, at approximately 1600 hours, I received permission from Detective [REDACTED]
 5 [REDACTED] to request members from the Riverside Treasure Hunter metal detector organization
 6 return to the scene on Eastridge Avenue and the 215 freeway overpass to search for Officer
 7 Moye's missing helmet emblem. I contacted Riverside Treasure Hunter [REDACTED] and
 8 requested his assistance to locate the missing emblem. On 8/20/2019, I requested the Riverside
 9 Treasure Hunters search the brush area north of Eastridge Avenue and the 215 freeway overpass,
 10 and east of the light pole nearest the overpass signage pole. At approximately 0900 hours, I
 11 received a phone notification from Riverside Treasure Hunter [REDACTED] that the missing
 12 emblem had been located.

13 **Photographs:**

14 On 8/20/2019, I took (12) digital photographs of the recovered helmet emblem and approximate
 15 area where Treasure Hunter [REDACTED] identified locating the emblem (hilly area north of north
 16 sidewalk, on northwest side of Eastridge Avenue and 215 freeway overpass), which I later
 17 downloaded to a secure file format in the Digital Information Management System (DIMS).

18 **Scene Processing:**

19 On 8/20/2019, at approximately 0949 hours, I arrived at Eastridge Avenue and the 215 freeway
 20 overpass. I contacted Riverside Treasure Hunter members [REDACTED]. I
 21 took possession of the recovered helmet emblem (Evidence Item #EMBLEM01) from Treasure
 22 Hunter [REDACTED], at approximately 0955 hours. Refer to the property report. At
 23 approximately 1004 hours, I cleared the scene and transported the item to the Magnolia Station.



Riverside Police Department

Officer Report

File Number:
190023109-100

24 **Evidence Collection:**

25 Evidence Item #EMBLEM01: Metal CHP helmet emblem (from Officer Moye's helmet)

26 **Evidence Disposition:**

27 On 8/20/2019, at approximately 1030 hours, I secured Item #EMBLEM01 in the secured
28 Forensics Unit Evidence Vault.

29 On 9/12/2019, I removed Item #EMBLEM01 from the secured Evidence Vault for packaging,
30 and released the item to Magnolia Station Property Locker #44, at approximately 1528 hours.
31 No further action was taken.

32

RIVERSIDE POLICE DEPARTMENT

Date Printed: 10/31/2022 9:11 AM	Case Report Number: 190023109-100	Page: 3 of 3	Ver. 1.3.3
-------------------------------------	--------------------------------------	-----------------	---------------



Riverside Police Department

Officer Report

File Number:
190023109-101

Administrative Information

Subject:		1111 - OFFICER NEEDS BACK-UP/URGENT RESPONSE			
Date(s) and Time(s) of Occurrence Or Between:		8/13/2019 6:53:00 AM //			
Location Of Occurrence:		Box Springs Bldg / Eastridge Ave RIVERSIDE			
Date/Time Reported:	8/12/2019 5:38:06 PM	Day:	Tuesday		
Date Of Report:	10/5/2019 2:36:14 PM	Type Of Premises:			
NPC:		RD:	PG08	Beat:	3
Was There a Witness To The Crime?					
Can a Suspect Be Named Or Identified?		By Whom?			
Can a Suspect Vehicle Be Identified?		By Whom?			

Code Section Classification:

Records Section

Reporting Officer:	[REDACTED]				
115 Qualified:	No				
Send Copies Of This Report To:					
DOJ/NCIC Entered?		Name/ID			
DOJ/NCIC Cancelled?		Name/ID			
APR Sent?		Name/ID			
APB Sent?		Name/ID			

Public Narrative

Supervisor Approving

Approving Supervisor:	[REDACTED]				
Date Reviewed:	10/8/2019 12:00:00 AM				

Evidence Information

Physical Evidence Present?		Physical Evidence Seized?	
----------------------------	--	---------------------------	--



Riverside Police Department

Officer Report

File Number:
190023109-101

Photographs Taken?	Yes	Photographer?	[REDACTED]
Weapon Seized?		Weapon(s) Taken For Safety?	No
Gang Related?	Unknown	Sensitive Data?	Yes
Fingerprint Search Made?	No	Fingerprints Obtained?	N/A
Narcotics Seized?		Narcotics Field Tested?	No
Audio Recording Available?	No	In Car Recording Available?	No
Body Worn Camera Recording Available?	No		
Type of Weapon, Force, Or Device Used?			
Motive:			

Narrative

1 **Case Type:**

2 187 PC / Homicide on a Peace Officer

3 OIS / Officer Involved Shooting

4 **Background:**

5 On 8/13/2019, at approximately 0653 hours, I returned to the scene of a homicide to assist the
 6 continued processing of the scene at Eastridge Avenue and Box Springs Boulevard. While
 7 waiting for the scene to be video taped and photographed, I received a verbal request from
 8 Detective [REDACTED] to document possible strike marks to 6596 Box Springs Boulevard (Vision
 9 Heating and Air Conditioning business). I also received a verbal request from Detective [REDACTED]
 10 [REDACTED] to collect possible blood samples from the helicopter used to transport a victim to the
 11 hospital. Later that day, I received a verbal request from Detective [REDACTED] to photograph
 12 and collect a rifle.

13 **Photographs:**

14 On 8/13/2019, I took (245) digital photographs of the helicopter used to transport the victim
 15 (#N911RP), secondary scene at 6596 Box Springs Boulevard and a charred rifle, which I later
 16 downloaded to a secure file format in the Digital Information Management System (DIMS).

17 **Scene Processing:**

18 At approximately 0800 hours, I cleared the scene and reported to the Riverside Police
 19 Department (RPD) Aviation Unit (7020 Central Avenue). At approximately 0829 hours, I
 20 arrived at the Aviation Unit. Mechanic [REDACTED] provided access to Helicopter #N911RP
 21 stationed in the Aviation Unit Hangar. I took digital photographs of the helicopter and possible



Riverside Police Department

Officer Report

File Number:
190023109-101

22 blood stains inside. I photographed, labeled and collected (4) possible blood stains from the
23 interior of the helicopter and operator helmets (Evidence Items #HELI01-HELI04), and a sterile
24 collection water sample (Evidence Item #HELI-WS). At approximately 0925 hours, I cleared
25 the Aviation Unit Hangar and transported all evidence items to the scene at Eastridge Ave. and
26 Box Springs Blvd. At approximately 0946 hours, I arrived at the scene and secured Items
27 #HELI01 through HELI-WS in my assigned forensics vehicle.

28 I contacted Detective [REDACTED] and walked to 6596 Box Springs Boulevard to document
29 possible strike marks on the building and a trailer. Detective [REDACTED] identified possible strike
30 marks to the east side of the building and an E-ZHAULER trailer unit (California Perm Trailer
31 [REDACTED]) on the east of the building. I conducted a projectile search with Detective [REDACTED] and
32 (3) projectiles were located north of the building in the main parking lot. I took digital
33 photographs of the scene and possible strike marks (exterior 6596 Box Springs Blvd. and
34 exterior/interior EZHAULER). I photographed, labeled, and collected the observed projectiles
35 (Evidence Items #BM01-BM03). I labeled and photographed multiple possible strike marks to
36 the E-ZHAULER as possible Strike Marks "BM-A" and "BM-A1" through "BM-A4". (3)
37 Possible strike marks were located towards the top of the building at 6596 Box Springs Blvd. I
38 requested the assistance of Public Utilities personnel to reach the strike marks.

39 I received a verbal request from Detective [REDACTED] chart and collect a rifle while waiting
40 for assistance from Public Utilities. I walked to the intersection of Eastridge Ave. and Box
41 Springs Blvd. to photograph, chart, and collect a rifle from the trunk of RPD Unit #3849. I took
42 digital photographs of the interior of RPD Unit #3849 and the rifle located in the rear trunk area.
43 Assisted by Detective [REDACTED] I photographed, charted, and collected the rifle from the trunk of
44 RPD Unit #3849 (Evidence Items #KF01, KF01-A, and KF01-B). I photographed and charted
45 spare magazines for the weapon, which were removed from the rifle storage bag Item #KF01
46 rested upon. I released the spare magazines to the rifle storage bag after charting. I secured the
47 items in my assigned forensics vehicle.

48 I returned to 6596 Box Springs Blvd. to document the possible strike marks toward the top of the
49 east wall. While waiting for assistance, I collected a scraping sample of metallic material on
50 possible Strike Mark "BM-A4" (Evidence Item #BM04). Assisted by Riverside Fire Department
51 Firefighters, I used the fire truck ladder to reach the remaining (3) possible strike marks towards
52 to top of the east wall. I labeled and photographed the possible strike marks as possible Strike
53 Marks "BM-B" through "BM-D". Refer to the evidence logs and weapon charting form. I took
54 perspective photographs from the approximate area of the east wall surveillance camera towards
55 the primary scene on the Eastridge Ave. and 215 freeway overpass.

56 I received verbal authorization from Sergeant [REDACTED] to clear the scene while FARO
57 digital scanning was to be completed. At approximately 1525 hours, I cleared the scene and
58 transported all evidence items to the Magnolia Station. I secured all evidence items in the
59 secured Forensics Unit Evidence Vault.

Date Printed: 10/31/2022 9:12 AM	Case Report Number: 190023109-101	Page: 3 of 4	Ver. 1.3.3
-------------------------------------	--------------------------------------	-----------------	---------------



Riverside Police Department

Officer Report

File Number:
190023109-101

60 On 8/19/2019, from approximately 1030-1720 hours, I removed Items #KF01, KF01-A and
61 KF01-B from the secured Forensics Unit Evidence Vault for packaging, and secured the items
62 after processing.

63 **Evidence Collection/Measurements:**

64 Refer to the evidence logs and weapon charting form.

65 **Evidence Disposition:**

66 On 8/13/2019, at approximately 1610 hours, I secured all evidence items into the secured
67 Forensics Unit Evidence Vault.

68 On 8/21/2019, at approximately 1412 hours, I removed Items #KF01, KF01-A and KF01-B from
69 the secured Evidence Vault and released them to Magnolia Station Property Specialist [REDACTED]
[REDACTED]

71 On 9/3/2019, at approximately 0915 hours, I removed Items #HELI01 through HELI-WS and
72 BM01-BM04 from the evidence vault for packaging. At approximately 1146 hours, I released
73 all evidence items to Magnolia Station Property Locker #16. No further action was taken.

74

RIVERSIDE POLICE DEPARTMENT



Riverside Police Department

Officer Report

File Number:
190023109-102

Administrative Information

Subject:	1111 - OFFICER NEEDS BACK-UP/URGENT RESPONSE				
Date(s) and Time(s) of Occurrence Or Between:	8/13/2019 7:33:00 PM //				
Location Of Occurrence:	Box Springs Bldg / Eastridge Ave RIVERSIDE				
Date/Time Reported:	8/12/2019 5:38:06 PM	Day:	Tuesday		
Date Of Report:	10/7/2019 6:40:08 PM	Type Of Premises:			
NPC:		RD:	PG08	Beat:	3
Was There a Witness To The Crime?					
Can a Suspect Be Named Or Identified?		By Whom?			
Can a Suspect Vehicle Be Identified?		By Whom?			

Code Section Classification:

Records Section

Reporting Officer:	[REDACTED]		
115 Qualified:	No		
Send Copies Of This Report To:			
DOJ/NCIC Entered?		Name/ID	
DOJ/NCIC Cancelled?		Name/ID	
APR Sent?		Name/ID	
APB Sent?		Name/ID	

Public Narrative

Supervisor Approving

Approving Supervisor:	[REDACTED]
Date Reviewed:	10/11/2019 12:00:00 AM

Evidence Information

Physical Evidence Present?		Physical Evidence Seized?	
----------------------------	--	---------------------------	--



Riverside Police Department

Officer Report

File Number:
190023109-102

Photographs Taken?	Yes	Photographer?	██████████
Weapon Seized?		Weapon(s) Taken For Safety?	No
Gang Related?	Unknown	Sensitive Data?	Yes
Fingerprint Search Made?	No	Fingerprints Obtained?	N/A
Narcotics Seized?		Narcotics Field Tested?	No
Audio Recording Available?	No	In Car Recording Available?	No
Body Worn Camera Recording Available?	No		
Type of Weapon, Force, Or Device Used?			
Motive:			

Narrative

1 **Case Type:**

2 187 P.C. / Homicide on a Peace Officer

3 OIS / Officer Involved Shooting

4 **Background:**

5 On 8/13/2019, at approximately 1933 hours, I returned to the scene of a homicide to assist the
6 continued processing of the scene at Eastridge Avenue and Box Springs Boulevard. I contacted
7 Detective ██████████ and was initially assigned to oversee the metal detector search by members
8 of the Treasure Hunters organization. Later, Detective ██████████ requested that I conduct
9 accountability charting on the rifles and shotguns inside the law enforcement vehicles on scene.
10 At the direction of Detective ██████████, I collected specific weapons from specified
11 vehicles.

12 **Photographs:**

13 From 8/13/2019 to 8/14/2019, I took (246) digital photographs of law enforcement vehicles that
14 we removed and charted weapons from, weapon chartings, and evidence items collected/charted,
15 which I later downloaded to a secure file format in the Digital Information Management System
16 (DIMS).

17 **Scene Processing:**

18 On 8/13/2019, I provided an initial brief of metal detector duties to the Riverside Treasure
19 Hunters volunteers and Property Specialist ██████████. I took identification photographs of
20 law enforcement vehicles that I removed charted weapons from and the location of the weapons.
21 I photographed and charted a shotgun from RPD (Riverside Police Department) Unit #3849
22 assisted by Detective ██████████ Ford Sedan, beige, California Exempt ██████████ (Unit #08-



Riverside Police Department

Officer Report

File Number:
190023109-102

23 228) did not have a rifle or shotgun inside. Assisted by Detective [REDACTED] I photographed
24 and charted California Highway Patrol (CHP) Unit #0798 (1-rifle, 1-shotgun), CHP Unit #4455
25 (1-rifle, shotgun not charted due to mechanical issue with rack lock), CHP Unit #1485 (1-rifle, 1-
26 shotgun), CHP Unit #5169 (1-rifle, 1-shotgun), Riverside Sheriff Office (RSO) Unit #18-003 (1-
27 shotgun from rack, 1-rifle and separated magazine removed from back seat), CHP Unit #3697 (1-
28 rifle, 1-shotgun), and CHP Unit #1660 (1-shotgun). The rifle removed from the back seat of
29 RSO Unit #18-003 was charted and collected as Evidence Item #VM01. For processing
30 purposes, I separated Item #VM01 into Items #VM01 and VM01-A through VM01-C. I was
31 assisted by Detective [REDACTED] in the weapon collection, charting, and photography. The weapon
32 charting and photography was generally observed and photographed in tandem with CHP
33 Officers.

34 I collected, photographed and charted a rifle inside of a case from the trunk of a Kia Optima,
35 white, California license [REDACTED] (Evidence Item #OV99). For processing purposes, I
36 separated Item #OV99 into Items #OV99, OV99-A, and OV99-B. I collected, photographed,
37 and charted Evidence Items #OV58, OV53 and OV47. For processing purposes, I separated
38 Item #OV58 into Items #OV58 and OV58-A. I collected Item #OV57, but did not chart and
39 photograph because the magazine was empty. Property Specialist [REDACTED] assisted the
40 photograph of Items #OV99, OV58, OV53 and OV47.

41 On 8/14/2019, at approximately 0354 hours, I cleared the scene and transported all evidence
42 items to the Magnolia Station.

43 On 8/19/2019, at approximately 1030 hours, I removed Items #OV58, OV58-A, and VM01-
44 VM01-C from the secured Evidence Vault for packaging. I secured the items in the vault after
45 processing, at approximately 1720 hours.

46 On 9/3/2019, at approximately 0915 hours, I removed Items #OV99, OV99-A, OV99-B, OV57,
47 OV53, and OV47 from the evidence vault for packaging.

Evidence Collection:

49 Refer to the property report, evidence logs, and weapon charting forms.

Evidence Disposition:

51 On 8/14/2019, at approximately 0430 hours, I secured all evidence items in the secured Forensics
52 Unit Evidence Vault.

53 On 8/21/2019, at approximately 1412 hours, I released Items #OV58, OV58-A, and VM01-
54 VM01-C to Magnolia Station Police Property Specialist [REDACTED].

55 On 9/3/2019, at approximately 1146 hours, I released Items #OV99-OV99-B, OV57, OV53, and
56 OV47 to Magnolia Station Property Locker #16. No further action was taken.

57

Date Printed: 10/31/2022 9:14 AM	Case Report Number: 190023109-102	Page: 3 of 3	Ver. 1.3.3
-------------------------------------	--------------------------------------	-----------------	---------------



Riverside Police Department

Officer Report

File Number:
190023109-103

Administrative Information

Subject:		1111 - OFFICER NEEDS BACK-UP/URGENT RESPONSE			
Date(s) and Time(s) of Occurrence Or Between:		8/20/2019 11:20:00 AM //			
Location Of Occurrence:		Box Springs Bldg / Eastridge Ave RIVERSIDE			
Date/Time Reported:	8/12/2019 5:38:06 PM	Day:	Tuesday		
Date Of Report:	10/23/2019 7:03:53 AM	Type Of Premises:			
NPC:		RD:	PG08	Beat:	3
Was There a Witness To The Crime?					
Can a Suspect Be Named Or Identified?		By Whom?			
Can a Suspect Vehicle Be Identified?		By Whom?			

Code Section Classification:

Records Section

Reporting Officer:	[REDACTED]				
115 Qualified:	No				
Send Copies Of This Report To:					
DOJ/NCIC Entered?		Name/ID			
DOJ/NCIC Cancelled?		Name/ID			
APR Sent?		Name/ID			
APB Sent?		Name/ID			

Public Narrative

Supervisor Approving

Approving Supervisor:	[REDACTED]				
Date Reviewed:	10/29/2019 12:00:00 AM				

Evidence Information

Physical Evidence Present?		Physical Evidence Seized?	
----------------------------	--	---------------------------	--



Riverside Police Department

Officer Report

File Number:
190023109-103

Photographs Taken?	Yes	Photographer?	[REDACTED]
Weapon Seized?		Weapon(s) Taken For Safety?	No
Gang Related?	Unknown	Sensitive Data?	Yes
Fingerprint Search Made?	No	Fingerprints Obtained?	N/A
Narcotics Seized?		Narcotics Field Tested?	No
Audio Recording Available?	No	In Car Recording Available?	No
Body Worn Camera Recording Available?	No		
Type of Weapon, Force, Or Device Used?			
Motive:			

Narrative

1 **Case Type:**

2 187 PC / Homicide of a Peace Officer

3 OIS / Officer Involved Shooting

4 **Background:**

5 On 8/20/2019, I received a request from Detective [REDACTED] to photograph, search, collect
6 projectiles and possible blood from a homicide investigation vehicle.

7 **Photographs:**

8 On 8/20/2019, I took (271) digital photographs of the vehicle, possible strike marks and evidence
9 collected, which I later downloaded to a secure file format in the Digital Information
10 Management System (DIMS). On 8/21/2019, I took (63) digital photographs of the
11 undercarriage of the vehicle, possible strike marks, evidence collected, and projectile search
12 damage to the vehicle, which I later downloaded to DIMS.

13 **Vehicle Processing:**

14 On 8/20/2019, at approximately 1120 hours, I arrived at the Vehicle: GMC truck, 2-door with
15 truck bed cover, California License [REDACTED] which was stored
16 in the secured Forensics Unit Vehicle Bay. I took digital photographs of the vehicle and
17 evidence collected. I observed multiple possible strike marks to the interior and exterior of the
18 vehicle, and possible blood stains on the exterior of the vehicle (front end, front passenger side
19 quarter panel, front passenger area, front driver side quarter panel). Detective [REDACTED]
20 searched the vehicle and requested collection of a possible blood stain (Evidence Item
21 #GMC01), possible DNA samples from the steering wheel (Evidence Item #GMC10), an



Riverside Police Department

Officer Report

File Number:
190023109-103

22 ammunition cartridge (Evidence Item #GMC02), receipts (Evidence Items #GMC03, GMC05),
23 keys (Evidence Item #GMC04), and mail (Evidence Item #GMC06). I collected a sterile
24 collection water sample (Evidence Item #GMC11). I conducted a search for strike marks and
25 projectiles. I observed, labeled, and photographed possible Strike Marks "A" through "R". I
26 recovered a projectile from Strike Mark "J" from the inside of the driver seat (Evidence Item
27 #GMC07) and a possible projectile from Strike Mark "O" from the inside of the front passenger
28 door (Evidence Item #GMC08). I conducted a search of the personal property in the rear truck
29 bed. I observed and photographed additional possible strike marks to personal property in the
30 truck bed. Intern [REDACTED] assisted with evidence documentation, photography, and
31 labeling. Refer to the property report, evidence log, and strike mark evidence logs. At
32 approximately 1706 hours, I cleared the vehicle and secured all evidence items in the secured
33 Forensics Unit Evidence Vault.

34 On 8/21/2019, at approximately 1420 hours, I returned to the vehicle. At my request, Fleet
35 Mechanics [REDACTED] #24839, [REDACTED] #25009 and [REDACTED] #25167 jumped the
36 battery of the vehicle and moved it to the neighboring vehicle bay for undercarriage review.
37 Detective [REDACTED] and I conducted an undercarriage search of the vehicle for additional strike
38 marks and projectiles. We located possible Strike Marks "G1" and "G2", which I labeled and
39 photographed. Fleet mechanics assisted the return of the vehicle to the Forensics Unit Vehicle
40 Bay. I continued a search for projectiles inside the vehicle. I located, photographed, and
41 collected documents related to the suspect from inside a golf bag (Evidence Item #GMC09)
42 removed from the truck bed. I labeled and photographed possible Strike Marks "S" and "T". I
43 observed and photographed additional possible strike marks to personal property in the truck
44 bed. Refer to the property report, evidence log, and strike mark evidence logs. The personal
45 property in the truck bed was identified at the crime scene as Evidence Items #OV25 and OV26.
46 At the direction of Detective [REDACTED] the personal property remained with the vehicle for
47 release. At approximately 1655 hours, I cleared the vehicle and secured all evidence items in the
48 secured Forensics Unit Evidence Vault.

Evidence Collection:

50 Refer to the evidence log and strike mark evidence logs.

Evidence Disposition:

52 On 8/20/2019, at approximately 1706 hours, I secured all evidence items in the secured Forensics
53 Unit Evidence Vault.

54 On 8/21/2019, at approximately 1655 hours, I secured all evidence items in the secured Forensics
55 Unit Evidence Vault.

56 On 9/4/2019, at approximately 1726 hours, I removed all evidence items from the secured
57 Evidence Vault and released them to Magnolia Station Property Locker #30. No further action
58 was taken.

59

Date Printed: 10/31/2022 9:16 AM	Case Report Number: 190023109-103	Page: 3 of 3	Ver. 1.3.3
-------------------------------------	--------------------------------------	-----------------	---------------



Riverside Police Department

Officer Report

File Number:
190023109-105

Administrative Information

Subject:	1111 - OFFICER NEEDS BACK-UP/URGENT RESPONSE				
Date(s) and Time(s) of Occurrence Or Between:	8/16/2019 8:10:00 AM //				
Location Of Occurrence:	Box Springs Bldg / Eastridge Ave RIVERSIDE				
Date/Time Reported:	8/12/2019 5:38:06 PM	Day:	Friday		
Date Of Report:	10/28/2019 8:44:45 AM	Type Of Premises:			
NPC:		RD:	PG08	Beat:	3
Was There a Witness To The Crime?					
Can a Suspect Be Named Or Identified?		By Whom?			
Can a Suspect Vehicle Be Identified?		By Whom?			

Code Section Classification:

Records Section

Reporting Officer:	[REDACTED]		
115 Qualified:	No		
Send Copies Of This Report To:			
DOJ/NCIC Entered?		Name/ID	
DOJ/NCIC Cancelled?		Name/ID	
APR Sent?		Name/ID	
APB Sent?		Name/ID	

Public Narrative

Supervisor Approving

Approving Supervisor:	[REDACTED]
Date Reviewed:	1/17/2020 12:00:00 AM

Evidence Information

Physical Evidence Present?		Physical Evidence Seized?	
----------------------------	--	---------------------------	--



Riverside Police Department

Officer Report

File Number:
190023109-105

Photographs Taken?	Yes	Photographer?	[REDACTED]
Weapon Seized?		Weapon(s) Taken For Safety?	Yes
Gang Related?	Unknown	Sensitive Data?	Yes
Fingerprint Search Made?	No	Fingerprints Obtained?	N/A
Narcotics Seized?		Narcotics Field Tested?	No
Audio Recording Available?	No	In Car Recording Available?	No
Body Worn Camera Recording Available?	No		
Type of Weapon, Force, Or Device Used?			
Motive:			

Narrative

1 **Case Type:**

2 187 PC / Homicide

3 OIS / Officer Involved Shooting

4 **Background:**

5 On 8/14/2019, I received a verbal request from Detective [REDACTED] to document possible
6 strike marks and recover projectiles from California Highway Patrol (CHP) Vehicle Unit #4455,
7 California License Plate [REDACTED], regarding a homicide and
8 OIS investigation. I was later notified that the vehicle would be processed on 8/16/2019, in
9 conjunction with a CHP representative.

10 On 8/16/2019 at approximately 0810 hours, I arrived at the vehicle, which was secured in the
11 Magnolia Station Forensics Unit Vehicle Bay. I contacted Detective [REDACTED], Detective [REDACTED]
12 [REDACTED] and CHP Investigator [REDACTED] #17875. Investigator [REDACTED] notified me that he
13 needed to take overall photographs of the vehicle, equipment within the vehicle, and firearms
14 within the vehicle.

15 **Photographs:**

16 On 8/16/2019, I took (367) digital photographs of CHP Unit #4455, identified electronic
17 equipment, firearms removed from unit, damage to the unit, possible strike marks, and evidence
18 collected. On 8/21/2019, I took (23) digital photographs of possible strike marks and evidence
19 collected. On 8/22/2019, I took (381) digital photographs of possible strike marks, officer gear
20 bags, evidence collected, and damage to the vehicle during the projectile recovery. On
21 8/26/2019, I took (237) digital photographs of possible strike marks and evidence collected. On
22 8/27/2019, I took (280) digital photographs of possible strike marks and evidence collected. On
23 8/29/2019, I took (270) digital photographs of possible strike marks and evidence collected. On



Riverside Police Department

Officer Report

File Number:
190023109-105

24 8/30/2019, I took (47) digital photographs of the projectile recovery damage to the unit. On
25 9/5/2019, I took (15) digital photographs of recovered projectile evidence. All of these
26 photographs were later downloaded to a secure file format in the Digital Information
27 Management System (DIMS).

28 The download for the 8/22/2019 (381) digital photographs experienced an error during the initial
29 download. The initial DIMS download attempt resulted in the first (106) photographs being
30 downloaded. The card was secured until a second download attempt was completed. They are a
31 duplicate of the first (106) photographs in the (381) digital photographs that were successfully
32 downloaded the second time.

33 Vehicle Processing:

34 On 8/16/2019, at approximately 0810 hours, I arrived at CHP Unit #4455 secured in the
35 Magnolia Station Forensics Unit Vehicle Bay. The vehicle had multiple possible strike marks to
36 the exterior and interior of the vehicle, and a visible projectile located on the rear bumper. Crime
37 scene personnel previously placed labels for possible Strike Marks "A" to "L" and "N" to "S" on
38 the front end of the vehicle. I took overall digital photographs of the interior and exterior of the
39 vehicle, possible strike marks, projectile evidence, and two firearms (shotgun and rifle) removed
40 from the vehicle by Investigator [REDACTED]. The shotgun was charted and labeled as Evidence Item
41 #WEAP01, and the rifle was labeled as Evidence Item #WEAP02. On 8/13/2019, the rifle had
42 been previously removed, charted, and replaced in the vehicle while on scene. Refer to the
43 weapon charting form and narrative for that day. Both weapons were collected for safekeeping.
44 I collected a projectile fragment from the strap of Item #WEAP01 (labeled as Evidence Item
45 #BMD01). Investigator [REDACTED] took digital photographs of Unit #4455 and select equipment,
46 and I photographed electronic equipment identified by Investigator [REDACTED].

47 Assisted by Detective [REDACTED] I conducted a search for projectiles and possible strike marks.
48 Multiple possible strike marks were identified, labeled, and photographed. Refer to the list of
49 possible strikes at the end of this report for 8/16/2019. Detective [REDACTED] completed a log of the
50 possible strike marks. I identified, labeled, photographed, and collected projectile related
51 Evidence Items #BMD01-BMD06 from Unit #4455. Refer to the attached evidence logs,
52 attached weapon charting form, and possible strike mark list at the end of this report. At
53 approximately 1550 hours, I secured all evidence items in the secured Forensics Unit Evidence
54 Vault.

55 Due to related casework assignments, I was not able to continue processing Unit #4455 until
56 8/21/2019. On 8/21/2019, at approximately 0900 hours, I arrived at Unit #4455 secured in the
57 Magnolia Station Forensics Unit Vehicle Bay. I began taking photographs of the vehicle interior
58 and observed possible strike marks. I identified, labeled, photographed, and collected projectile
59 related Evidence Item #BMD07. Refer to the attached evidence logs. Due to another case
60 assignment, I cleared the vehicle and secured Item #BMD07 in the secured Forensics Unit
61 Evidence Vault, at approximately 0925 hours.

62 On 8/22/2019, at approximately 0815 hours, I arrived at Unit #4455 secured in the Magnolia
63 Station Forensics Unit Vehicle Bay. I continued a search for projectiles and possible strike

Date Printed: 10/31/2022 9:17 AM	Case Report Number: 190023109-105	Page: 3 of 4	Ver. 1.3.3
-------------------------------------	--------------------------------------	-----------------	---------------



Riverside Police Department

Officer Report

File Number:
190023109-105

64 marks. I removed an officer's gear bags from the front passenger compartment of the vehicle for
65 release to the officer. I observed and photographed a possible fabric wear mark on the base of the
66 larger bag.

67 For distinction, the interior vehicle possible strike marks that could not be linked to an exterior
68 possible strike mark were identified by placing an "T" in front of the letter designator. I
69 conducted a search for projectiles and possible strike marks. Multiple possible strike marks were
70 identified, labeled, and photographed. Refer to the list of possible strikes at the end of this report
71 for 8/22/2019. I identified, labeled, and photographed projectile related Evidence Item
72 #BMD09. I identified, labeled, photographed, and collected projectile related Evidence Items
73 #BMD08, BMD10-BMD17 from Unit #4455. Detective [REDACTED] and Intern [REDACTED]
[REDACTED] assisted possible strike mark documentation by completing a log of the possible strike
75 marks before the vehicle was moved for the undercarriage search. Fleet Mechanic [REDACTED]
[REDACTED] assisted me in photography of possible Strike Marks "T" and "U". The vehicle could
77 not be moved to the Fleet Vehicle Bay, adjacent to the Forensics Unit Vehicle Bay, for an
78 undercarriage projectile search due to the deflated tires. Fleet Mechanic [REDACTED] removed
79 the tires from the vehicle and placed Fleet issued tires on the vehicle. The evidence tires were
80 secured in the Forensics Unit Vehicle Bay.

81 At approximately 1447 hours, at the direction of Sergeant [REDACTED] I released the officer gear
82 bags to CHP Officer [REDACTED].

83 Assisted by multiple personnel, Fleet Mechanic [REDACTED] and I pushed Unit #4455 into the Fleet Bay
84 next door. Fleet Mechanic [REDACTED] positioned Unit #4455 on a vehicle lift, to allow photography
85 and a search for additional possible strike marks and projectiles. Multiple possible strike marks
86 were identified, labeled, and photographed. Refer to the list of possible strikes at the end of this
87 report for 8/22/2019. Intern [REDACTED] assisted the documentation of possible strike marks and
88 evidence recovery efforts during the undercarriage search. Fleet Mechanic [REDACTED] used his
89 automotive training and experience to assist the recovery of projectile related evidence by cutting
90 and/or dismantling the vehicle as needed to search for projectiles. I photographed the damage
91 completed on the undercarriage of the vehicle during projectile recovery. I identified, labeled,
92 photographed, and collected projectile related Evidence Items #BMD18-BMD22 from Unit
93 #4455. Intern [REDACTED] assisted completion of the evidence log during vehicle processing. Refer
94 to the attached evidence logs and possible strike mark list at the end of this report. At
95 approximately 1800 hours, I secured all evidence items in the secured Forensics Unit Evidence
96 Vault. At approximately 1815 hours, Fleet Mechanic [REDACTED], multiple personnel, and I pushed
97 Unit #4455 back into the secured Forensics Unit Vehicle Bay.

98 On 8/26/2019, at approximately 0900 hours, I arrived at Unit #4455 secured in the Magnolia
99 Station Forensics Unit Vehicle Bay. I continued a search for projectiles and possible strike
100 marks in the vehicle. Multiple possible strike marks were identified, labeled, and photographed.
101 Refer to the list of possible strikes at the end of this report for 8/26/2019. Fleet Mechanic [REDACTED]
[REDACTED] used his automotive training and experience to assist the recovery of projectile related
103 evidence by cutting and/or dismantling the vehicle as needed to search for projectiles. I
104 identified, labeled, photographed, and collected projectile related Evidence Items #BMD23-

Date Printed: 10/31/2022 9:17 AM	Case Report Number: 190023109-105	Page: 4 of 5	Ver. 1.3.3
-------------------------------------	--------------------------------------	-----------------	---------------



Riverside Police Department

Officer Report

File Number:
190023109-105

105 BMD25 from Unit #4455. At approximately 1300 hours, I secured all evidence items in the
106 Forensics Unit Evidence Vault. After a short break, I returned to continue processing the vehicle
107 with Fleet Mechanic [REDACTED]. Multiple possible strike marks were identified, labeled, and
108 photographed. Refer to the list of possible strikes at the end of this report for 8/26/2019. I
109 identified, labeled, photographed, and collected projectile related Evidence Items #BMD26-
110 BMD33 from Unit #4455. Refer to the attached evidence logs and possible strike mark list at the
111 end of this report. At approximately 1730 hours, I secured all evidence items in the Forensics
112 Unit Evidence Vault.

113 On 8/27/2019, at approximately 0820 hours, I arrived at Unit #4455 secured in the Magnolia
114 Station Forensics Unit Vehicle Bay. I continued a search for projectiles and possible strike
115 marks in the vehicle. Multiple possible strike marks were identified, labeled, and photographed.
116 Refer to the list of possible strikes at the end of this report for 8/27/2019. Fleet Mechanic [REDACTED]
[REDACTED] used his automotive training and experience to assist the recovery of projectile related
118 evidence by cutting and/or dismantling the vehicle as needed to search for projectiles. I
119 identified, labeled, photographed, and collected projectile related Evidence Items #BMD09, and
120 BMD34-BMD44 from Unit #4455. Refer to the attached evidence logs and possible strike mark
121 list at the end of this report. Intern [REDACTED] assisted the documentation of possible strike marks
122 and evidence recovery efforts. At approximately 1748 hours, I secured all evidence items in the
123 Forensics Unit Evidence Vault.

124 On 8/29/2019, at approximately 0900 hours, I arrived at Unit #4455 secured in the Magnolia
125 Station Forensics Unit Vehicle Bay. I continued a search for projectiles and possible strike
126 marks in the vehicle. Multiple possible strike marks were identified, labeled, and photographed.
127 Refer to the list of possible strikes at the end of this report for 8/29/2019. Fleet Mechanic [REDACTED]
128 [REDACTED] used his automotive training and experience to assist the recovery of projectile related
129 evidence by cutting and/or dismantling the vehicle as needed to search for projectiles. I
130 identified, labeled, photographed, and collected projectile related Evidence Items #BMD45-
131 BMD52 from Unit #4455.

132 At approximately 1315 hours, I secured Unit #4455's (4) removed vehicle tires and spare tire in
133 my assigned forensic van and transported the tires to the Fleet Department Vehicle Bay (8095
134 Lincoln Avenue) with Intern [REDACTED]. At approximately 1330 hours, we arrived at the
135 Fleet Department Vehicle Bay. I continued a search for projectiles and possible strike marks on
136 the exterior/interior of each wheel/tire. Multiple possible strike marks were identified, labeled,
137 and photographed. Refer to the list of possible strikes at the end of this report for 8/29/2019.
138 Fleet Mechanic [REDACTED] removed the metal wheel from the tires for projectile recovery. Intern
139 [REDACTED] assisted the documentation of possible strike marks and evidence recovery efforts. I
140 identified, labeled, photographed, and collected projectile related Evidence Items #BMD54-
141 BMD57 from the wheels/tires of Unit #4455. Refer to the attached evidence logs and possible
142 strike mark list at the end of this report. At approximately 1634 hours, Intern [REDACTED] and I
143 cleared the Fleet Department Vehicle Bay and transported all evidence items to the Magnolia
144 Station Forensics Unit Vehicle Bay. We arrived at the Magnolia Station Vehicle Bay, at
145 approximately 1655 hours. Fleet Mechanics [REDACTED] removed the temporary tires

Date Printed: 10/31/2022 9:17 AM	Case Report Number: 190023109-105	Page: 5 of 6	Ver. 1.3.3
-------------------------------------	--------------------------------------	-----------------	---------------



Riverside Police Department Officer Report

File Number:
190023109-105

146 from Unit #4455 and replaced the original evidence tires on the vehicle. The spare was secured
147 with the vehicle.

148 Soon after the vehicle was secured in the vehicle bay on 8/14/2019, an observable gasoline leak
149 was observed from one of the gas tanks. The initial gas leak was absorbed using a rocky
150 absorbent material, which was bagged and retained as it was replaced. On 8/29/2019, prior to
151 disposal of the absorbent material, I conducted a metal detector search for projectile related
152 evidence assisted by Intern [REDACTED]. No projectile evidence was located and the absorbent
153 material was disposed of. At approximately 1708 hours, I secured all evidence items and the
154 digital photograph card in the Forensics Unit Evidence Vault.

155 On 8/30/2019, at approximately 1057 hours, I arrived at Unit #4455 secured in the Magnolia
156 Station Forensics Unit Vehicle Bay. I took overall photographs of damage to the vehicle from
157 the projectile search. At approximately 1142 hours, I cleared the vehicle.

158 On 9/5/2019, at approximately 1750 hours, I removed Items #BMD06 and BMD54-BMD57
159 from the evidence vault. I took digital photographs of the evidence items. At approximately
160 1840 hours, I secured all evidence items.

161 **Evidence Collection/Measurements:**

162 Refer to the attached evidence logs, attached weapon charting form, and possible strike mark list
163 below.

164 **Evidence Disposition:**

165 On 8/28/2019, I removed Items #WEAP01 and WEAP02 from the Forensics Unit Evidence
166 Vault, and released them to Magnolia Station Police Property Specialist [REDACTED], at
167 approximately 1557 hours.

168 On 9/9/2019, I removed all remaining evidence items from the Forensics Unit Evidence Vault,
169 and released them to Magnolia Station Property Locker #37, at approximately 1215 hours. No
170 further action was taken.

171

172 **8/16/2019 Magnolia Station-Possible Strike Mark Log**

A	Exterior front windshield (driver's side, lower)
B	Exterior front windshield (driver's side, lower)
C	Exterior front windshield (driver's side, center)
D	Exterior front windshield (center/upper)
E	Exterior front windshield (center/upper)
F	Exterior front windshield (driver's side, center)
G	Exterior front windshield (driver's side, center)
H	Exterior front windshield (driver's side, upper)
I	Front bumper (driver's side)



Riverside Police Department

Officer Report

File Number:
190023109-105

J	Front bumper (driver's side, below headlight)
K	Front hood (driver's side, front)
L	Front bumper (driver's side, below grill)
M	Front bumper (driver's side, below grill)
N	Front push bar (driver's side)
O	Front push bar (driver's side light)
P	Front bumper and grill (driver's side)
Q	Front hood (center; front)
R	Exterior roof (passenger side, front)
S	Exterior roof (passenger side, front)
T	Roof light bar (driver's side, rear of light)
U	Roof light bar (center, rear of light)
V	Side rear view mirror arm (passenger side, back side)
W	Side rear view mirror arm and case (passenger side, mirror side)
X	Exterior front passenger door (upper)
Y	Roof light bar (center, front)
Z	Roof light bar (driver's side, front)
AA	Roof light bar (driver's side, front)
BB	Driver's side rear door window
CC	Exterior bottom driver's door plastic panel
DD	Exterior bottom driver's door plastic panel
EE	Driver's side rear quarter panel
FF	Driver's side rear quarter panel
GG	Driver's side rear quarter panel window
HH	Driver's side rear quarter panel window frame
II	Driver's side rear bumper
JJ	Driver's side rear bumper
KK	Driver's side rear deck lid (trunk door, exterior)
LL	Driver's side rear tail light
MM	Driver's side rear deck lid (trunk door, exterior)
NN	Driver's side rear deck lid (trunk door, exterior)
OO	Driver's side rear deck lid (trunk door, exterior)
PP	Driver's side rear bumper (upper)
QQ	Driver's side rear bumper (lower)
RR	Rear bumper (driver side)
SS	Rear bumper (driver side)
TT	Exterior rear window (center)
UU	Exterior rear window (passenger side)
VV	Exterior rear window (passenger side)



Riverside Police Department

Officer Report

File Number:
190023109-105

WW	Exterior rear window (passenger side)
XX	Exterior passenger side rear deck lid (trunk door)
YY	Passenger side rear tail light
ZZ	Passenger side rear bumper (lower)
AAA	Exterior spare tire well (under vehicle), rear
BBB	Rear bumper (underside)
CCC	Exterior spare tire well (under vehicle), rear
DDD	Rear passenger side exhaust muffler
EEE	Exterior spare tire well (under vehicle)
FFF	Driver side suspension/frame (rear)
GGG	Rear driver side exhaust pipe (rear)
HHH	Rear driver side exhaust pipe (rear)
III	Rear passenger side exhaust pipe (rear)
JJJ	Rear passenger side exhaust pipe (rear)
KKK	Intentionally not used as possible strike mark designator
LLL	Driver's side windshield wiper arm
MMM	Driver side suspension/frame (rear)
NNN	Passenger side undercarriage (rear)
OOO	Exterior roof (rear driver's side)

173

174 **8/22/2019 Magnolia Station-Possible Strike Mark Log**

175 "I" Designator in front of possible strike mark letter(s) denotes a possible strike mark to the vehicle
176 cabin interior

B1	Interior front windshield (driver's side, lower)
C1	Interior front windshield (driver's side, center)
D1	Interior front windshield (driver's side, center)
E1	Interior front windshield (driver's side, center)
F1	Interior front windshield (driver's side, center)
G1	Interior front windshield (driver's side, center)
H1	Interior front windshield (driver's side, upper)
K1	Interior front hood, driver's side
K2	Engine compartment plastic cover, driver's side
K3	Interior front hood, driver's side
K4	Engine compartment plastic cover, driver's side
K5	Driver's side, windshield wiper
K6	Interior driver's side of front hood
Q1	Interior front hood, center
Q2	Interior front hood strut tower brace



Riverside Police Department

Officer Report

File Number:
190023109-105

Q3	Fabric liner under interior front hood strut tower brace
KK1	Interior trunk door panel, driver side
MM1	Interior trunk door panel, driver side
NN1	Interior trunk door panel, driver side
OO1	Interior trunk door panel, driver side
RR1	Interior rear bumper, driver side
RR2	Exterior rear of spare tire well, driver side
SS1	Exterior rear of spare tire well, driver side
XX1	Interior trunk door (deck lid), passenger side
XX2	Interior trunk doorway frame, passenger side
XX3	Interior trunk door (deck lid), passenger side
ZZ1	Passenger side rear bumper (interior)
ZZ2	Rear passenger side fender wiring, undercarriage
ZZ3	Rear passenger side fender wiring, undercarriage
ZZ4	Rear side of rear passenger fender well (rear portion)
ZZ5	Front side of rear passenger fender well (rear portion)
PPP	Undercarriage cover for EVAP canister, rear passenger side
QQQ	Front driver's side inner fender well
RRR	Passenger side rear exhaust muffler
SSS	Rear side of rear passenger fender well (front portion)
SSS1	Front side of rear passenger fender well (front portion)
TTT	Front side of rear passenger fender well (front portion)
TTT1	Rear side of rear passenger fender well (front portion)
UUU	Rear passenger side unibody undercarriage
VVV	Exterior passenger side fuel tank
WWW	Driver side exhaust system pipe
XXX	Exterior driver side fuel tank
YYY	Exterior driver side fuel tank
ZZZ	Unibody liner, near center muffler
AAAA	Unibody liner, near center muffler
BBBB	Rear passenger side unibody undercarriage
CCCC	Rear passenger side unibody undercarriage
DDDD	Rear passenger side unibody undercarriage
EEEE	Rear passenger side unibody undercarriage
FFFF	Front driver's side undercarriage sub frame
GGGG	Front driver's side inner fender well (interior side)
GGGG1	Front driver's side inner fender well (exterior side)
HHHH	Front driver's side, lower engine pan cover
IIII	Front driver's side, lower engine pan cover



Riverside Police Department

Officer Report

File Number:
190023109-105

JJJJ	Passenger side fuel tank **Changed from UUU**
KKKK	Rear passenger side exhaust pipe (rear)
I-A	Front driver side clear plastic shield, between door and front divider gate (front)
I-A1	Rear driver side of roll bar padding on front divider gate (rear).
I-B	Front driver side clear plastic shield, between door and front divider gate (front)
I-B1	Rear driver side of roll bar padding on front divider gate (rear).
I-C	Driver's seat head rest (left side)
I-D	Driver's side front divider gate (front)
I-D1	Rear driver's side front divider gate (rear)
I-E	Upper right shoulder of driver's seat back rest
I-F	Gun rack frame, front cabin
I-G	Driver's side front divider gate (front)
I-G1	Rear driver's side front divider gate (rear)
I-H	Front passenger side front divider gate (front)
I-H1	Rear passenger side front divider gate (rear)
I-I	Gun rack frame, front cabin
I-J	Front passenger side front divider gate (front)
I-J1	Rear passenger side front divider gate (rear)
I-K	Front passenger side front divider gate (front) roll bar foam
I-K1	Rear passenger side front divider gate (rear) roll bar foam
I-L	Front passenger side clear plastic shield, between door and front divider gate (front)
I-L1	Rear passenger side clear plastic shield, between door and front divider gate (rear)
I-M	Front passenger side clear plastic shield, between door and front divider gate (front)
I-M1	Rear passenger side clear plastic shield, between door and front divider gate (rear)
I-M2	Rear passenger side roll bar foam of front divider gate (rear)
I-N	Front passenger side clear plastic shield, between door and front divider gate (front)
I-O	Front passenger seat ceiling roof liner
I-P	Interior rear view mirror case
I-P1	Interior rear view mirror
I-Q	Front passenger seat ceiling roof liner
I-R	Front passenger seat ceiling roof liner
I-S	Interior rear driver side doorway frame



Riverside Police Department

Officer Report

File Number:
190023109-105

I-S1	Interior rear driver side door
I-T	Rear driver side trunk rear divider gate wall (rear)
I-T1	Rear driver side rear divider gate wall (front)
I-U	Rear driver side trunk rear divider gate wall (rear)
I-U1	Rear driver side rear divider gate wall (front)
I-V	Rear driver side plastic framed compartment behind seat back
I-W	Rear driver side seat back
I-X	Rear driver side of front divider gate wall (rear)
I-Y	Ceiling roof liner above center rear passenger seat
I-Z	Center, top of rear divider gate frame (front)
I-AA	Center of rear divider gate (front)
I-BB	Rear passenger side of rear divider gate (front)
I-CC	Rear passenger side of rear divider gate (front)
I-DD	Rear passenger side of rear divider gate (front)
I-EE	Rear passenger side of rear divider gate (front)
I-FF	Rear passenger side, top of rear gate frame (front)
I-GG	Ceiling roof liner above rear driver seat
I-HH	Ceiling roof liner above rear passenger side seat
I-II	Ceiling roof liner above rear passenger side seat
I-JJ	Ceiling roof liner above center rear passenger seat
I-KK	Front passenger seat ceiling roof liner
I-LL	Front passenger side front divider gate (front) roll bar foam
I-MM	Center, front divider gate (front) roll bar foam
I-NN	Driver's side front divider gate (front)
I-OO	Steering wheel
I-PP	Ceiling roof liner above trunk (center)
I-QQ	Ceiling roof liner above trunk (center)
I-RR	Trunk ceiling roof liner, passenger side
I-SS	Trunk wood tray (top edge) and flare in top metal drawer
I-SS1	Trunk top metal drawer front (exterior)
I-TT	Dog snare pole, trunk top electronics tray
I-UU	Driver's side of trunk middle electronics tray drawer
I-VV	Driver's side of trunk lower electronics tray drawer
I-WW	Driver's side of trunk, plastic side wall
I-XX	Trunk, driver's side of top wood tray/shelf (rear)
I-YY	Front passenger seat ceiling roof liner **Changed from I-P**
I-ZZ	Rear driver side clear plastic shield, between door and rear divider gate (rear)

177 8/26/2019 Magnolia Station-Possible Strike Mark Log

Date Printed: 10/31/2022 9:17 AM	Case Report Number: 190023109-105	Page: 11 of 12	Ver. 1.3.3
-------------------------------------	--------------------------------------	-------------------	---------------



Riverside Police Department

Officer Report

File Number:
190023109-105

178 "I" Designator in front of possible strike mark letter(s) denotes a possible strike mark to the vehicle
179 cabin interior

K7	Interior front hood, driver's side
K8	Lower cowl panel, driver's side
K9	Lower cowl panel, driver's side
K10	Engine compartment firewall, driver's side
Q4	Lower front windshield cowl panel, passenger side
Q5	Dashboard fire wall behind cowl panel, passenger side
Z1	Interior light components of light bar
AA1	Interior light components of light bar
LLLL	Engine compartment cooling fan (front)
LLLL1	Engine compartment cooling fan (rear)
MMMM	Engine compartment cooling fan (front)
MMMM1	Engine compartment cooling fan (rear)
NNNN	Engine compartment condenser (front layer)
OOOO	Engine compartment condenser (front layer)
PPPP	Transmission cooler (front)
QQQQ	Radiator (rear layer)
RRRR	Underside of light bar
RRRR1	Exterior roof under light bar, passenger side
I-E1	Driver's side front divider gate wall (front), behind driver seat
I-O1	Ceiling headliner (interior side), front passenger side against metal roof of vehicle
I-Q1	Ceiling headliner (interior side), front passenger side against metal roof of vehicle
I-YY1	Ceiling headliner (interior side), front passenger side against metal roof of vehicle

180

181 **8/27/2019 Magnolia Station-Possible Strike Mark Log**

182 "I" Designator in front of possible strike mark letter(s) denotes a possible strike mark to the vehicle
183 cabin interior

J1	Interior front driver side quarter panel area , under headlight
J2	Interior front driver side quarter panel area, behind headlight
J3	Interior front driver side quarter panel area, behind headlight fender bracket
J4	Interior front driver side quarter panel area, behind headlight fender bracket
J5	Interior front driver side fender well frame extension



Riverside Police Department

Officer Report

File Number:
190023109-105

J6	Interior front driver side fender well frame extension
CC1	Exterior bottom driver's door plastic panel (interior side)
CC2	Driver's door, behind bottom plastic panel
DD1	Label not used
DD2	Exterior bottom driver's door plastic strip (interior side)
JJ1	Interior lower bumper frame, rear driver side
KK2	Interior rear trunk door frame
KK3	Interior rear trunk door panel fabric padding
MM2	Interior rear trunk door frame
MM3	Interior rear trunk door panel fabric padding
NN2	Interior rear trunk door frame
NN3	Interior rear trunk door panel fabric padding
OO2	Interior rear trunk door frame
OO3	Interior rear trunk door panel fabric padding
QQQ1	Inner fender well metal, front driver's side
RRRR2	Interior front passenger metal roof
I-X1	Driver side of front divider gate wall (front)
I-TT1	Dog snare pole, trunk top tray
I-AAA	Driver side trunk area cup holder compartment plastic frame
I-BBB	Driver headrest (rear)
I-CCC	Driver headrest (rear)
I-DDD	Base of driver headrest (driver side)
I-EEE	Rear side of rear driver side seat back rest
I-FFF	Wood tray (exterior, rear), from top shelf of trunk racks near Strike Mark I-XX
I-FFF1	Wood tray (interior, front), from top shelf of trunk racks
I-GGG	Emergency blanket package in top rack of trunk wood tray

184

185 **8/29/2019** **Magnolia Station-Possible Strike Mark Log**

H1	Driver "A" pillar airbag; DUPLICATE LETTERING
SS2	Interior spare tire well
RR3	Interior spare tire well
AAA1	Interior spare tire well
CCC1	Interior spare tire well
EEE1	Interior spare tire well
EEE2	Carpet of spare tire well
OOO1	Interior side of trunk metal roof, driver side
OOO2	Rear side of trunk area headliner A/C vent, driver side
OOO3	Front side of trunk area headliner A/C vent, driver side



Riverside Police Department Officer Report

File Number:
190023109-105

186

187 8/29/2019 Fleet Services-Possible Strike Mark Log

188 "T" Designator in front of possible strike mark letter(s) denotes a vehicle tire possible strike mark

T-A	Exterior tread of spare tire
T-A1	Interior wall of spare tire
T-B	Exterior tread of spare tire
T-B1	Interior wall of spare tire
T-C	Exterior tread of spare tire
T-C1	Interior wall of spare tire
T-D	Exterior tread of spare tire
T-D1	Interior wall of spare tire
T-E	Interior wall of spare tire
T-F	Interior wall of spare tire
T-G	Exterior tread of driver front tire
T-G1	Interior wall of driver front tire
T-H	Exterior tread of driver front tire
T-H1	Interior wall of driver front tire
T-I	Interior wall of driver front tire
T-I1	Exterior tread of driver front tire
T-J	Interior wall of driver front tire
T-K	Exterior tread of front passenger tire
T-K1	Interior wall of front passenger tire
T-L	Exterior tread of passenger rear tire
T-L1	Interior wall of passenger rear tire
T-M	Exterior tread of passenger rear tire
T-M1	Interior wall of passenger rear tire
T-N	Exterior tread of passenger rear tire
T-N1	Interior wall of passenger rear tire
T-O	Exterior tread of passenger rear tire
T-P	Exterior wall of passenger rear tire
T-P1	Interior wall of passenger rear tire
T-Q	Exterior tread of passenger rear tire
T-Q1	Interior wall of passenger rear tire

189

190

191



Riverside Police Department

Officer Report

File Number:
190023109-106

Administrative Information

Subject:	1111 - OFFICER NEEDS BACK-UP/URGENT RESPONSE				
Date(s) and Time(s) of Occurrence Or Between:	//				
Location Of Occurrence:	Box Springs Bldg / Eastridge Ave RIVERSIDE				
Date/Time Reported:	8/12/2019 5:38:06 PM	Day:			
Date Of Report:	10/31/2019 10:58:52 AM	Type Of Premises:			
NPC:		RD:	PG08	Beat:	3
Was There a Witness To The Crime?					
Can a Suspect Be Named Or Identified?		By Whom?			
Can a Suspect Vehicle Be Identified?		By Whom?			

Code Section Classification:

Records Section

Reporting Officer:	[REDACTED]		
115 Qualified:	No		
Send Copies Of This Report To:			
DOJ/NCIC Entered?		Name/ID	
DOJ/NCIC Cancelled?		Name/ID	
APR Sent?		Name/ID	
APB Sent?		Name/ID	

Public Narrative

Supervisor Approving

Approving Supervisor:	[REDACTED]
Date Reviewed:	11/5/2019 12:00:00 AM

Evidence Information

Physical Evidence Present?		Physical Evidence Seized?	
----------------------------	--	---------------------------	--



Riverside Police Department

Officer Report

File Number:
190023109-106

Photographs Taken?	Yes	Photographer?	[REDACTED]
Weapon Seized?		Weapon(s) Taken For Safety?	No
Gang Related?	No	Sensitive Data?	Unknown
Fingerprint Search Made?	No	Fingerprints Obtained?	N/A
Narcotics Seized?		Narcotics Field Tested?	No
Audio Recording Available?	No	In Car Recording Available?	No
Body Worn Camera Recording Available?	No		
Type of Weapon, Force, Or Device Used?			
Motive:			

Narrative

1 **Case Type:**

2 OIS / Officer Involved Shooting

3 187 PC / Homicide

4

5 **Service Requested:**

6 On 08/21/2019, at approximately 1430 hours, I was requested by Supervising Forensic Specialist
7 [REDACTED] to photograph and process the below listed vehicle for possible strike mark
8 documentation and projectile recovery. I was also advised to document and collect the shotgun
9 assigned to this vehicle.

10

11 **Ford Crown Victoria Moreno Valley Police Unit (RSO) 11-246 (LIC#1378955/CA Exempt)**

12

13 At this time, I responded to the secured Magnolia Station parking lot where the vehicle was
14 stored and took photographs of the patrol unit. Please reference the supplemental report that
15 refers to this date and the collection of the shotgun (MOR07).

16

17 **Photographs Taken:**

18 On 08/22/2019, at approximately 0715 hours, I responded to the secured Magnolia Station
19 parking lot where the vehicle was stored. I took additional photographs of the exterior and
20 interior of the vehicle. A total of 119 photographs were downloaded to the secured Digital
21 Information Management System (DIMS).

22

23 **Latent Examination:**

24 Not requested.

25

26 **Evidence Collection:**



Riverside Police Department

Officer Report

File Number:
190023109-106

27 On 08/22/2019, at approximately 0950 hours, Det. [REDACTED] responded to my location and
28 assisted me with examining the vehicle. I collected a sample swab of possible blood from the
29 rear passenger seat which was packaged and labeled MOR01. A sample swab of sterile
30 collection water was also collected and labeled MOR06. Possible strike marks were located to
31 the front driver side bumper and interior front driver side door which were identified and labeled
32 "A," "B," and "B1." I located and collected evidence item MOR02 near possible strike marks B
33 and B1. I removed the interior front driver door panel with the assistance of Riverside Police
34 Department Mechanic [REDACTED]. Within the interior portion of the front driver door panel (behind
35 panel), I located and collected evidence items MOR03 and MOR04. During this time, I secured
36 evidence items MOR01 through MOR04 and MOR06 inside the forensic unit vault. The vehicle
37 was then moved from its location to a vehicle lift in order to access and examine the
38 undercarriage. No items of evidence were located on the undercarriage. [REDACTED] removed parts of
39 the vehicle where possible strike mark A was located. Once this area was removed, possible
40 strike mark "A1" was identified and labeled. Evidence item MOR05 was then collected from this
41 location. After I finished processing the vehicle, I secured evidence item MOR05 and the vehicle
42 keys inside the forensic unit vault at approximately 1238 hours.

43

44 Evidence Disposition:

45 On 08/22/2019, at approximately 1443 hours, I met with Riverside County Sheriff's Deputy
46 [REDACTED] and released his assigned duty gear which had been located inside the trunk of the
47 vehicle. At approximately 1600 hours, I met with Riverside County Sheriff's Deputy [REDACTED]
48 and released his assigned duty gear which was also located inside the trunk of the vehicle.

49

50 On 08/23/2019, at approximately 0835 hours, I removed evidence items MOR01 through
51 MOR06 from the secured forensic unit vault. I released these items to Magnolia Station property
52 locker #42 at approximately 1106 hours.

53

54 On 08/29/2019, at approximately 0925 hours, I removed the vehicle keys from the secured
55 forensic unit vault and released them to Detective [REDACTED] with the Riverside County Sheriff's
56 Department.

57

58 Please reference attached evidence log and property report for further information.

59

60 No further action was taken.

61

62

Date Printed: 10/31/2022 9:19 AM	Case Report Number: 190023109-106	Page: 3 of 3	Ver. 1.3.3
-------------------------------------	--------------------------------------	-----------------	---------------



Riverside Police Department

Officer Report

File Number:
190023109-107

Administrative Information

Subject:		1111 - OFFICER NEEDS BACK-UP/URGENT RESPONSE			
Date(s) and Time(s) of Occurrence Or Between:		10/24/2019 8:44:00 AM //			
Location Of Occurrence:		Box Springs Bldg / Eastridge Ave RIVERSIDE			
Date/Time Reported:	8/12/2019 5:38:06 PM	Day:	Thursday		
Date Of Report:	11/23/2019 9:51:23 PM	Type Of Premises:			
NPC:		RD:	PG08	Beat:	3
Was There a Witness To The Crime?					
Can a Suspect Be Named Or Identified?		By Whom?			
Can a Suspect Vehicle Be Identified?		By Whom?			

Code Section Classification:

Records Section

Reporting Officer:	[REDACTED]				
115 Qualified:	No				
Send Copies Of This Report To:					
DOJ/NCIC Entered?		Name/ID			
DOJ/NCIC Cancelled?		Name/ID			
APR Sent?		Name/ID			
APB Sent?		Name/ID			

Public Narrative

Supervisor Approving

Approving Supervisor:	[REDACTED]				
Date Reviewed:	11/26/2019 12:00:00 AM				

Evidence Information

Physical Evidence Present?		Physical Evidence Seized?	
----------------------------	--	---------------------------	--



Riverside Police Department

Officer Report

File Number:
190023109-107

Photographs Taken?	Yes	Photographer?	[REDACTED]
Weapon Seized?		Weapon(s) Taken For Safety?	No
Gang Related?	Unknown	Sensitive Data?	Yes
Fingerprint Search Made?	No	Fingerprints Obtained?	N/A
Narcotics Seized?		Narcotics Field Tested?	No
Audio Recording Available?	No	In Car Recording Available?	No
Body Worn Camera Recording Available?	No		
Type of Weapon, Force, Or Device Used?			
Motive:			

Narrative

1 **Case Type:**

2 187 PC / Homicide

3 OIS / Officer Involved Shooting

4 **Service Requested:**

5 NIBIN Test-fire and Photographs of Rifle

6 **Requested by:**

7 On 10/23/2019, I received a request from Magnolia Station Property Specialist [REDACTED]
8 to collect test-fire cartridge case exemplars from Evidence Item #OV99: "SAVAGE" .22 LR
9 caliber rifle semi-auto, model 64, serial #2937401.

10 **Evidence Check-out:**

11 On 10/24/2019, at approximately 0844 hours, I checked out Item #OV99 from Magnolia Station
12 Police Property Unit [REDACTED].

13 **Examination:**

14 I transported the item to the Lincoln Station and arrived at approximately 0909 hours. I reported
15 to the Lincoln Station firing range and contacted Range Master [REDACTED]. While in my
16 presence, Range Master [REDACTED] completed a safety check on Item #OV99, and deemed it
17 operable. He fired (2) .22 caliber cartridges through Item #OV99. At approximately 0952 hours,
18 I collected the (2) expended cartridge case exemplars (Evidence Item #TF01). Refer to the
19 property report. I completed the test-fire assignment assisted by Range Master [REDACTED]. At
20 approximately 1001 hours, I cleared the Lincoln Station and transported Items #OV99 and TF01



Riverside Police Department

Officer Report

File Number:
190023109-107

21 to the Magnolia Station. At approximately 1134 hours, I secured Items #OV99 and TF01 in the
22 secured Forensics Unit Evidence Vault.

23 **Photographs:**

24 On 10/24/2019, I took (6) digital photographs of Item #OV99, which I later downloaded to a
25 secure file format in the Digital Information Management System (DIMS).

26 **Evidence Collection:**

27 Item #TF01: (2) Expended .22 caliber cartridge case test-fire exemplars- from Item #OV99

28 **Evidence Disposition:**

29 On 10/24/2019, I removed all evidence items from the Forensics Unit Evidence Vault and
30 released them to Magnolia Station Property Locker #16, at approximately 1454 hours. No
31 further action was taken.

32

RIVERSIDE POLICE DEPARTMENT



Riverside Police Department

Officer Report

File Number:
190023109-108

Administrative Information

Subject:		1111 - OFFICER NEEDS BACK-UP/URGENT RESPONSE			
Date(s) and Time(s) of Occurrence Or Between:		//			
Location Of Occurrence:		Box Springs Bldg / Eastridge Ave RIVERSIDE			
Date/Time Reported:	8/12/2019 5:38:06 PM	Day:			
Date Of Report:	12/18/2019 11:06:13 AM	Type Of Premises:			
NPC:		RD:	PG08	Beat:	3
Was There a Witness To The Crime?					
Can a Suspect Be Named Or Identified?		By Whom?			
Can a Suspect Vehicle Be Identified?		By Whom?			

Code Section Classification:

Records Section

Reporting Officer:	[REDACTED]				
115 Qualified:	No				
Send Copies Of This Report To:					
DOJ/NCIC Entered?		Name/ID			
DOJ/NCIC Cancelled?		Name/ID			
APR Sent?		Name/ID			
APB Sent?		Name/ID			

Public Narrative

Supervisor Approving

Approving Supervisor:	[REDACTED]				
Date Reviewed:	12/23/2019 12:00:00 AM				

Evidence Information

Physical Evidence Present?		Physical Evidence Seized?	
----------------------------	--	---------------------------	--



Riverside Police Department

Officer Report

File Number:
190023109-108

Photographs Taken?	No	Photographer?	
Weapon Seized?		Weapon(s) Taken For Safety?	No
Gang Related?	No	Sensitive Data?	Unknown
Fingerprint Search Made?	No	Fingerprints Obtained?	N/A
Narcotics Seized?		Narcotics Field Tested?	No
Audio Recording Available?	No	In Car Recording Available?	No
Body Worn Camera Recording Available?	No		
Type of Weapon, Force, Or Device Used?			
Motive:			

Narrative

1 **Case Type:**

2 OIS / Officer Involved Shooting

3 187 PC / Homicide

4

5 **Service Requested:**

6 On 12/10/2019, at approximately 0959 hours, I received a request from Police Property
7 Specialist [REDACTED] to transport, inspect, and test fire the below listed evidence item
8 by Lincoln Station range staff.

9

10 **OV016- Black unknown make and caliber semi-auto assault rifle, unknown model
11 and serial number**

12

13 At approximately 1049 hours, I received the above listed evidence item from Police
14 Property Specialist [REDACTED] and secured the item inside the forensic unit vault at
15 approximately 1500 hours.

16

17 **Photographs Taken:**

18 Photographs were taken of the above listed item previously and are located in the
19 Digital Information Management System (DIMS).

20

21 **Evidence Collection:**

22 On 12/11/2019, at approximately 1315 hours, I removed evidence item OV016 from the
23 forensic unit vault and transported the item to Lincoln Station where I arrived at
24 approximately 1332 hours. Upon arrival, I met with Assistant Range Master [REDACTED]
25 and Assistant Range Master [REDACTED] who inspected the item and deemed it
26 operable. [REDACTED] fired (2) 5.56 caliber cartridges down range. I collected (2) 5.56
27 caliber cartridge cases from the ground labeled TF-02 (see attached property report). I



Riverside Police Department

Officer Report

File Number:
190023109-108

28 cleared Lincoln Station at approximately 1448 hours. I transported all evidence back to
29 Magnolia Station where I secured the items inside the forensic unit vault at
30 approximately 1505 hours.

31

32 Evidence Disposition:

33 On 12/13/2019, at approximately 0740 hours, I removed OV016 and TF-02 from the
34 secured forensic unit vault. I released OV016 to Police Property Specialist [REDACTED]
35 at approximately 0834 hours. I released TF-02 to Magnolia Station property locker #43
36 at approximately 1200 hours.

37

38 No further action was taken.

39

40

41

42

RIVERSIDE POLICE DEPARTMENT

Date Printed: 10/31/2022 9:23 AM	Case Report Number: 190023109-108	Page: 3 of 3	Ver. 1.3.3
-------------------------------------	--------------------------------------	-----------------	---------------



Riverside Police Department

Officer Report

File Number:
190023109-109

Administrative Information

Subject:	1111 - OFFICER NEEDS BACK-UP/URGENT RESPONSE				
Date(s) and Time(s) of Occurrence Or Between:	//				
Location Of Occurrence:	Box Springs Bldg / Eastridge Ave RIVERSIDE				
Date/Time Reported:	8/12/2019 5:38:06 PM	Day:			
Date Of Report:	1/13/2020 11:06:02 AM	Type Of Premises:			
NPC:		RD:	PG08	Beat:	3
Was There a Witness To The Crime?					
Can a Suspect Be Named Or Identified?			By Whom?		
Can a Suspect Vehicle Be Identified?			By Whom?		

Code Section Classification:

Records Section

Reporting Officer:	[REDACTED]		
115 Qualified:	Yes		
Send Copies Of This Report To:			
DOJ/NCIC Entered?		Name/ID	
DOJ/NCIC Cancelled?		Name/ID	
APR Sent?		Name/ID	
APB Sent?		Name/ID	

Public Narrative

Supervisor Approving

Approving Supervisor:	[REDACTED]
Date Reviewed:	1/14/2020 12:00:00 AM

Victim Information

PURSUANT TO CALIFORNIA PENAL CODE SECTION 293(a)/CONFIDENTIAL FORM(S) ATTACHED?:		Yes
Code:	Name:	[REDACTED]
Victim Type:	Law Enforcement Officer	Will the victim prosecute?



Riverside Police Department

Officer Report

File Number:
190023109-109

Sex:	Male	Race:	Hispanic		
Height:	5' 11"	Weight:	195		
Hair:		Eyes:			
Notes:					

Victim Scars, Marks and Tattoos

Scar, Mark, Tattoo	Scar, Mark, Tattoo Location	Description
--------------------	-----------------------------	-------------

Victim Domestic Violence Information (If Applicable)

Emotional State:	Appearance:	Injuries:	Sobriety/Drug:
Victim Advised of Citizen's Arrest Rights?			
Victim Given "Alternatives To Domestic Violence" Card?			
Victim Given Agency Report Number?			
Victim Given Department Phone Number?			
Victim Advised Of Public Record/Privacy, 293(a) PC?			

Victim Vehicle Information:

Make	Model	Year	Color	License No.
------	-------	------	-------	-------------

Victim Injuries:

Injuries:	
If Treated For Injuries, By Whom?	
If Hospitalized, Where?	
Date/Time:	
Nature of Injuries:	
Injury Weapons:	

Victim Addresses:

Address Type	Address	City, State ZIP	County
Work	8118 Lincoln Ave	Riverside	Riverside

Victim Phones:

Phone Type	Phone Number
------------	--------------



Riverside Police Department

Officer Report

File Number:
190023109-109

Work	(951) 637-8000
------	----------------

Evidence Information

Physical Evidence Present?		Physical Evidence Seized?	
Photographs Taken?		Photographer?	
Weapon Seized?		Weapon(s) Taken For Safety?	
Gang Related?		Sensitive Data?	
Fingerprint Search Made?		Fingerprints Obtained?	
Narcotics Seized?		Narcotics Field Tested?	
Audio Recording Available?		In Car Recording Available?	
Body Worn Camera Recording Available?			
Type of Weapon, Force, Or Device Used?			
Motive:			

Narrative

1 Details:

2 I am a Detective assigned to the Robbery/Homicide unit. On 12/04/19, an
3 interview was conducted of CHP Officer [REDACTED] officer involved shooting
4 incident. The interview was conducted by me and my partner Detective
5 [REDACTED] (Co-Case) at Officer [REDACTED] residence; due to his current medical
6 condition.

7
8 The interview was audio recorded. After the interview, the audio recording was
9 downloaded into the departments PUMA audio recording system, and
10 accessible via Laserfiche for review.

11
12 ***The following is a synopsis of the conversation. It is not verbatim, nor
13 necessarily in order of conversation, and is organized for the purposes of
14 clarity. This report is not meant to take the place of the actual recording. It is
15 just a synopsis. For complete details refer to the recording of the interview. ***

16
17 Officer [REDACTED] Interview (12/04/19)
18 On 12-04-19 at approximately 1100 hours, Detective [REDACTED] and I
19 interviewed the involved CHP Officer, Robert [REDACTED] Also present during the



Riverside Police Department

Officer Report

File Number:
190023109-109

20 interview was Riverside County Deputy District Attorney [REDACTED]
21 Riverside County District Attorney's Office Investigator [REDACTED] and CHP
22 Officer [REDACTED] (Area Representative for Officer [REDACTED])
23

24 I started the interview by advising Officer [REDACTED] his report will be submitted to
25 the District Attorney's Office for review. I told him he did not have to speak
26 with us and that he could not be disciplined for not speaking with us. I asked
27 Officer [REDACTED], other than the public safety statement, has anyone ordered him to
28 give a statement and he said, "No." Officer [REDACTED] was asked if he wished to
29 speak to us at this time and he said, "Yes."
30

31 Officer [REDACTED] then provided the following information: [REDACTED]
[REDACTED], 5 years of service (with the California
33 Highway Patrol, currently assigned to the Riverside Station, 5'11", 195 lbs.,
34 Date of hire 08/2014, patrol start date was 03/2015, rank is Officer, works
35 "B" watch (1300-2230), call sign was "Boy 74-25", single person unit, and the
36 uniform he was wearing at the time of the incident was his tan CHP uniform
37 (Class A.) Officer [REDACTED] said his unit had video, which was activated during the
38 incident.
39

40 Officer [REDACTED] was asked if he had a chance to review all known audio/video
41 recordings of the incident and he said, "No." (which was a personal choice,
42 Officer [REDACTED] elected not to watch the video of the incident prior to his
43 interview.)
44

45 He was asked what weapon he used during the incident and how it was loaded
46 or configured. Officer [REDACTED] said he used his Smith & Wesson MMP 40. caliber
47 pistol; which was loaded to capacity (fifteen round magazine/4 magazines on
48 his belt) with one round chambered. Officer [REDACTED] said he fired approximately 76
49 rounds and was injured during the incident. Officer [REDACTED] sustained major
50 trauma to both lower legs, left hand, back area (right side) and shrapnel to
51 both forearms. Officer [REDACTED] said he is currently taking the following
52 medications: Tylenol, Tramadol, Gabapentin, and baby Aspirin.
53

54 Officer [REDACTED] said he was driving in his beat (60 fwy. from 215 interstate to
55 Gilman Springs Rd.,) and heard Officer Moye put out a tow truck request on
56 Eastridge. Officer Paul went to Officer Moye's stop to provide routine back-up
57 and walked up on the curb and saw the white truck and all his (S/Luther's)
58 stuff lined up on the sidewalk.
59

60 Officer [REDACTED] said he walked around and talked with Officer Moye and decided it
61 was a good training moment, because Officer Moye is the most junior officer at

Date Printed: 10/31/2022 9:24 AM	Case Report Number: 190023109-109	Page: 4 of 5	Ver. 1.3.3
-------------------------------------	--------------------------------------	-----------------	---------------



Riverside Police Department

Officer Report

File Number:
190023109-109

62 the station. Officer ██████ said Officer Moyer told him the registration tag was not
63 S/Luther's. Officer ██████ said he started texting (then calling) another co-worker
64 about running the serial number on the registration tag.

65
66 Officer ██████ said while he was talking to Officer Moyer about the different ways
67 to enforce registration tags from misdemeanors to felonies, S/Luther was polite
68 and following orders and moving stuff out of his vehicle. Officer ██████ said
69 Officer Moyer told him he was, "good," so he (Officer Paul) started to walk
70 towards his unit to catch a call in his beat.

71
72 Officer ██████ said as he approached his vehicle his back was facing them
73 (Officer Moyer and S/Luther) when he heard, "fireworks." Officer ██████ said at
74 first he thought somebody driving by the traffic stop was playing a prank on
75 them. Officer ██████ said he turned around and saw the tow truck; with its bed
76 on the ground, "take off," and he heard a, "grunt." (Which Officer ██████ later
77 realized was the sound of Officer Moyer hitting the ground.)

78
79 Officer ██████ said he looked on the sidewalk and saw Officer Moyer lying on the
80 ground, but did not see S/Luther. Officer ██████ said he then realized someone
81 was shooting at him. Officer ██████ said he drew his pistol and fired down range
82 over the hood of his car. Officer ██████ said he fired towards S/Luther's white
83 truck, and he saw S/Luther duck away out of sight.

84
85 Officer ██████ said because he did not have any cover by his driver side window,
86 he retreated to the rear of his patrol car and broadcasted, "11-99, officer down,
87 I'm in a gun fight."

88
89 Officer ██████ said as he was behind his patrol vehicle he performed a tactical re-
90 load and was under constant gun fire. Officer ██████ said the gunfire never
91 stopped and he remembered getting hit in his right leg, and there was so much
92 pain.

93
94 Officer ██████ said he thought he would be, "Ok," and he could walk but when he
95 tried to walk he fell. Officer ██████ said shots were still coming and he was trying
96 to look for S/Luther's feet and fire at his feet. Officer Paul saw S/Luther's feet
97 get closer, and then he felt a bullet pierce his left leg and it was horrible pain.
98 Officer ██████ said he continued to re-load, and asked for more back-up over the
99 radio.

100
101 Officer ██████ said he saw the amount of blood squirting out of his legs and from
102 being on-scene of fatal accidents, he knew he would die. Officer ██████ said he
103 had to keep fighting, so he re-loaded again and fired towards S/Luther.

Date Printed: 10/31/2022 9:24 AM	Case Report Number: 190023109-109	Page: 5 of 6	Ver. 1.3.3
-------------------------------------	--------------------------------------	-----------------	---------------



Riverside Police Department

Officer Report

File Number:
190023109-109

104
105 Officer ██████ said Officer ██████ arrived on-scene and they both kept shooting.
106 Officer ██████ said he told Officer ██████ he had to lay down cover fire, stay
107 aggressive or this guy (S/Luther) is going to advance. Officer Paul said Officer
108 ██████ started dragging him towards the rear of a vehicle, and he heard shots
109 flying right past them.

110
111 Officer ██████ said a Riverside County Sherriff vehicle showed up and they tried
112 to get him in the back of that unit, and it was super painful. Officer ██████ said
113 he pulled himself up into the unit and a deputy in training applied a tourniquet
114 on his right leg. Officer ██████ said he got another tourniquet applied to his right
115 leg and they stopped the bleeding.

116
117 Officer ██████ said it was a very hot ride to the hospital in the back of the unit.
118 Officer ██████ said he could feel the blood on the plastic seats and he was sliding
119 around and that was causing pain on his shattered bones, and he saw the
120 bottom of his boot.

121
122 Officer ██████ said at the hospital he remained conscious and remembers
123 receiving "O" type blood and calling his girlfriend ██████ and his parents.

124
125 Officer ██████ said S/Luther was a middle-aged white male, short, lots of tattoos,
126 a little over weight, and grey scruffy hair. Officer ██████ said he did not remember
127 what S/Luther had in his hands, but just remembers seeing the muzzle flash.

128
129 Officer ██████ said he did not conduct an inventory of S/Luther's possessions,
130 and did not look into his vehicle. Officer ██████ said S/Luther told him his wife
131 was coming to pick him up.

132
133 Officer ██████ said when he heard the zipping of bullets go past his head and the
134 dust coming from the impacts, he felt in fear for his life and Officer Moye's life.

135
136 I had Officer ██████ indicate on a set of photographs of the crime scene, what he
137 had just described to us during his interview in regards to positioning and
138 movements (the photos were later collected and placed into a property locker at
139 the Magnolia Station).

140
141 ***At this time of the interview, we took a break in the interview and returned a
142 short time later. ***

143
144 At the conclusion I asked Officer ██████ if he had anything to add or if he had
145 any questions, and he said, "No."

Date Printed: 10/31/2022 9:24 AM	Case Report Number: 190023109-109	Page: 6 of 7	Ver. 1.3.3
-------------------------------------	--------------------------------------	-----------------	---------------



Riverside Police Department Officer Report

File Number:
190023109-109

146
147 NFD
148

RIVERSIDE POLICE DEPARTMENT

Date Printed: 10/31/2022 9:24 AM	Case Report Number: 190023109-109	Page: 7 of 7	Ver. 1.3.3
-------------------------------------	--------------------------------------	-----------------	---------------



Riverside Police Department

Officer Report

File Number:
190023109-110

Administrative Information

Subject:	187 (A) - PC - MURDER - Murder/Nonnegligent Manslaughter - F				
Date(s) and Time(s) of Occurrence Or Between:	//				
Location Of Occurrence:	Box Springs Bldg / Eastridge Ave RIVERSIDE				
Date/Time Reported:	8/12/2019 5:38:06 PM	Day:			
Date Of Report:	1/10/2020 4:13:21 PM	Type Of Premises:			
NPC:		RD:	PG08	Beat:	3
Was There a Witness To The Crime?					
Can a Suspect Be Named Or Identified?		By Whom?			
Can a Suspect Vehicle Be Identified?		By Whom?			

Code Section Classification:

Records Section

Reporting Officer:	[REDACTED]		
115 Qualified:	Yes		
Send Copies Of This Report To:			
DOJ/NCIC Entered?		Name/ID	
DOJ/NCIC Cancelled?		Name/ID	
APR Sent?		Name/ID	
APB Sent?		Name/ID	

Public Narrative

I responded to the scene of the shooting where I used the Department's LASER scanner to document the evidence and the area's physical features.

Supervisor Approving

Approving Supervisor:	[REDACTED]
Date Reviewed:	1/16/2020 12:00:00 AM

Other Entities



Riverside Police Department

Officer Report

File Number:
190023109-110

Name:	[REDACTED]				
Entity Type:	Other (Person)	Code:			
Sex:	Male	Race:		DOB:	
Height:		Weight:			
Hair:		Eyes:			
Notes:					

Witness Addresses:

Address Type	Address	City, State ZIP	County
Work	San Bernardino County Sheriff Dept 655 E Third St	San Bernardino, CA 92415	San Bernardino

Witness Phones:

[REDACTED]	[REDACTED]
[REDACTED]	[REDACTED]

Other Entities

Name:	[REDACTED]				
Entity Type:	Other (Person)	Code:			
Sex:		Race:		DOB:	
Height:		Weight:			
Hair:		Eyes:			
Notes:					

Witness Addresses:

Address Type	Address	City, State ZIP	County
[REDACTED]	[REDACTED]	[REDACTED]	

Witness Phones:

[REDACTED]	[REDACTED]
[REDACTED]	[REDACTED]
[REDACTED]	[REDACTED]

Other Entities

Name:	[REDACTED]				
Entity Type:	Other (Person)	Code:			



Riverside Police Department

Officer Report

File Number:
190023109-110

Sex:		Race:		DOB:	
Height:		Weight:			
Hair:		Eyes:			
Notes:					

Witness Addresses:

Witness Phones:

Other Entities

Entity Type:	Other (Person)	Code:			
Sex:		Race:		DOB:	
Height:		Weight:			
Hair:		Eyes:			
Notes:					

Witness Addresses:

Witness Phones:

Evidence Information

Physical Evidence Present?		Physical Evidence Seized?	
Photographs Taken?		Photographer?	
Weapon Seized?		Weapon(s) Taken For Safety?	



Riverside Police Department

Officer Report

File Number:
190023109-110

Gang Related?		Sensitive Data?	
Fingerprint Search Made?		Fingerprints Obtained?	
Narcotics Seized?		Narcotics Field Tested?	
Audio Recording Available?		In Car Recording Available?	
Body Worn Camera Recording Available?			
Type of Weapon, Force, Or Device Used?			
Motive:			

Narrative

1 On August 12, 2019, at around 1815 hours, I was in my office when I was informed there had
 2 been an officer involved shooting involving the death of a CHP officer. At around 1830 hours, I
 3 received a telephone call from Supervising Forensic Specialist [REDACTED] [REDACTED]
 4 [REDACTED] asked if I could respond to the scene to assist with documenting the crime scene.
 5 Anticipating that the involvement of personnel at the scene would be extensive, I prepared the
 6 Traffic Bureau's DUI Checkpoint trailer, along with my equipment, and responded to the scene's
 7 Command Post. I arrived at the CP at approximately 2015 hours.
 8

9 I spoke with Detective [REDACTED]. He asked that I coordinate with [REDACTED] in documenting
 10 the scene using the Department's FARO Focus^S 350 Laser Scanner. After being told the extent of
 11 the scene, I received permission from Lieutenant [REDACTED] to attempt to enlist the assistance of
 12 additional FARO scanner-trained personnel. I telephoned [REDACTED], Regional Account
 13 Manager FARO Technologies, Inc., and asked him if he knew of any other local law enforcement
 14 agencies who might be able and qualified to assist me. He recommended and put me in
 15 contact with San Bernardino County Sheriff Department Forensic Evidence Supervisor [REDACTED]
 16 [REDACTED]. I spoke with [REDACTED] and it was decided he would respond to assist me with the
 17 scene documentation, bringing an additional two FARO Focus^S 350 scanners.
 18

19 At around 1915 hours, it was decided to "freeze" the scene and wait until daybreak the
 20 following morning to continue documentation. I called and notified [REDACTED] of the delay and asked
 21 him to respond in the morning after 0830 hours. I remained at the scene until around 2310
 22 hours before returning to the RPD Lincoln Station.
 23

24 I returned to the scene on August 13, at around 0730 hours. SBCSD-CSI Forensic Supervisor
 25 [REDACTED] arrived at the scene at approximately 0800 hours, bringing with him two FARO scanners. I
 26 requested RPD Officer [REDACTED] respond to the scene to assist with the operation of the 3rd scanner
 27 once scene documentation commenced. He arrived a short time later.
 28



Riverside Police Department

Officer Report

File Number:
190023109-110

29 I spoke with California Highway Patrol Major Accident Investigation Team Sergeant [REDACTED]. He
30 told me his team had brought an additional (Leica) laser scanner and offered their assistance. I
31 divided the area to be documented into 4 sections, divided from east to west. I assigned the
32 CHP MAIT to scan the western most area; I would scan the next eastern area; [REDACTED] would scan
33 the next eastern area including the suspect's position; and [REDACTED] would scan the eastern most
34 area.

35
36 The FARO Focus^S 350 laser scanner emits a modulated infrared laser beam from a rotating
37 mirror towards its surrounding environment. The scanner rotates to cover a 360° horizontal by
38 300° vertical field of view. Scattered light from surrounding objects is reflected back into the
39 scanner. The scanner calculates an object's distance by measuring the phase shifts in the waves
40 of returned infrared light. The X,Y,Z coordinates of each point are then calculated using angle
41 encoders to measure the mirror rotation position and the horizontal rotation position of the
42 Focus^S. These angles are encoded simultaneously with the distance measurement, which is
43 then transformed to a Cartesian coordinate for each point. Each resulting scan contains an
44 assembly of millions of three-dimensional measurement points, known as a point cloud. The
45 scans are stored on a removable memory card. Using FARO's SCENE software, multiple scans
46 captured at a location are aligned to create a single unified three-dimensional data set (called a
47 project point cloud) through a process known as registration. Once registered, the project point
48 cloud can be used to visualize the scanned location from any perspective within the scanned
49 area.

50
51 We received notification that initial processing of the scene had been completed at about 1345
52 hours. Evidence placards had been placed and the area and items photographed. I requested
53 all non-essential personnel exit the scene and we began scanning at about 1400 hours.

54
55 I was contacted at the scene by CHP MAIT Investigator [REDACTED]. [REDACTED] had brought a
56 Unmanned Aerial Vehicle (UAV/drone) and offered to use it to photograph the scene; he would
57 later process the photographs using Pix4D to create a project point cloud similar to that created
58 by the FARO laser scanners. I agreed and requested he begin as soon as able.

59
60 At about 1645 hours, I was told by Sergeant [REDACTED] that the CHP MAIT's scanner had failed and
61 they were unable to recover their recorded data. Their completed scans appeared to have been
62 lost and the scanner would no longer function. I asked [REDACTED] to discontinue scanning the area to
63 the east and directed him to begin scanning Eastridge Avenue from the west side of Box Springs
64 Boulevard to the east. He began scanning again at about 1710 hours.

65
66 We completed scanning at about 2040 hours. I collected the scans from all three scanners onto
67 a portable hard drive, a separate removable media card, and the hard drive on my Department
68 issued laptop computer.

69

Date Printed: 10/31/2022 9:29 AM	Case Report Number: 190023109-110	Page: 5 of 6	Ver. 1.3.3
-------------------------------------	--------------------------------------	-----------------	---------------



Riverside Police Department

Officer Report

File Number:
190023109-110

70 I remained at the scene and assisted the RPD Forensic Evidence Technicians with the placement
71 of lights and other duties as requested. I cleared the crime scene location at about 0420 hours
72 on August 14, 2019.

73
74 I arrived at the Lincoln station at about 0450 hours. Once there, I copied the scans onto the
75 Department's secure network storage.

76
77 I began processing the scans on the afternoon of August 14, 2019 using the FARO SCENE
78 application. I processed a total of 57 scans to create the project point cloud. Once the project
79 point cloud had been created, I prepared the data for review.

80
81 On August 29, 2019, I received an email from RPD Senior Evidence Technician [REDACTED]
82 identified three evidence items which were located at the scene during the forensic
83 documentation phase, but after scanning had been completed. Detective [REDACTED] had
84 established a reference point on the southeast corner of Eastridge Avenue, immediately east of
85 Box Springs Boulevard and had recorded measurements for each item. The items were:

86
87 OV091: (1) "WMA 16" cartridge case from brush area
88 4'1" South of the south curb line of Eastridge Avenue and
89 62'8" East of the reference point.

90
91 OV092: (1) "WMA 16" cartridge case from brush area
92 2'0" South of the south curb line of Eastridge Avenue and
93 63'7" East of the reference point.

94 OV093: (1) "Federal 40 S&W" cartridge case from brush area
95 8'6" South of the south curb line of Eastridge Avenue and
96 126'8" East of the reference point.

97
98 On September 19, 2019, I met with CHP MAIT Officer [REDACTED]. He provided me with
99 scan data of the scene created using their drone.

100
101 I imported the CHP drone scan data into FARO's Zone 3D computer aided diagramming
102 software. I used the software to create a traditional, overhead two-dimensional diagram of the
103 crime scene.

104
105 I imported the project point cloud I had previously created using the SCENE software into Zone
106 3D. I used the software to mark the evidence and involved vehicles within the crime scene. I
107 included the additional items (OV091-OV093) provided by SET [REDACTED] marked the physical
108 evidence placards using yellow, numbered virtual placards. I reviewed the photographs of the
109 evidence taken at the scene. I then linked the virtual evidence placards to photographs of each
110 evidence item documented within the scans.

Date Printed: 10/31/2022 9:29 AM	Case Report Number: 190023109-110	Page: 6 of 7	Ver. 1.3.3
-------------------------------------	--------------------------------------	-----------------	---------------



Riverside Police Department

Officer Report

File Number:
190023109-110

111
112 During the original scanning process, CHP MAIT investigators had placed 2-foot square, black
113 and white checkerboard reference markers at several locations throughout the scene. These
114 reference markers were present in the scans we created as well as in the drone scan data
115 provided by the CHP. Using the reference markers, I used Zone 3D to import the diagrammed
116 evidence and vehicle items created from our scan data into the roadway diagram created from
117 the CHP drone data, creating one inclusive crime scene diagram.
118
119 I then used FARO's SCENE 2go software to export the project point cloud, evidence
120 photographs, and diagrams into a single, accessible application. I uploaded a copy of the
121 application and related files to the Department's LaserFiche system for secure storage. I copied
122 the package onto a removable memory device which I later booked into Property.
123

RIVERSIDE POLICE DEPARTMENT

Date Printed: 10/31/2022 9:29 AM	Case Report Number: 190023109-110	Page: 7 of 7	Ver. 1.3.3
-------------------------------------	--------------------------------------	-----------------	---------------



Riverside Police Department

Officer Report

File Number:
190023109-111

Administrative Information

Subject:	1111 - OFFICER NEEDS BACK-UP/URGENT RESPONSE				
Date(s) and Time(s) of Occurrence Or Between:	//				
Location Of Occurrence:	Box Springs Bldg / Eastridge Ave RIVERSIDE				
Date/Time Reported:	8/12/2019 5:38:06 PM	Day:			
Date Of Report:	1/15/2020 1:51:35 PM	Type Of Premises:			
NPC:		RD:	PG08	Beat:	3
Was There a Witness To The Crime?					
Can a Suspect Be Named Or Identified?		By Whom?			
Can a Suspect Vehicle Be Identified?		By Whom?			

Code Section Classification:

Records Section

Reporting Officer:	[REDACTED]		
115 Qualified:	No		
Send Copies Of This Report To:			
DOJ/NCIC Entered?		Name/ID	
DOJ/NCIC Cancelled?		Name/ID	
APR Sent?		Name/ID	
APB Sent?		Name/ID	

Public Narrative

Supervisor Approving

Approving Supervisor:	[REDACTED]
Date Reviewed:	1/27/2020 12:00:00 AM

Evidence Information

Physical Evidence Present?		Physical Evidence Seized?	
----------------------------	--	---------------------------	--



Riverside Police Department

Officer Report

File Number:
190023109-111

Photographs Taken?	Yes	Photographer?	██████████
Weapon Seized?		Weapon(s) Taken For Safety?	Yes
Gang Related?	No	Sensitive Data?	Unknown
Fingerprint Search Made?	No	Fingerprints Obtained?	N/A
Narcotics Seized?		Narcotics Field Tested?	No
Audio Recording Available?	No	In Car Recording Available?	No
Body Worn Camera Recording Available?	No		
Type of Weapon, Force, Or Device Used?			
Motive:			

Narrative

1 **Case Type:**

2 OIS / Officer Involved Shooting
3 187 PC / Homicide
4

5 **Service Requested:**

6 On 08/12/2019, at approximately 1817 hours, I was requested by Sgt ██████████ to respond to the
7 location of Sycamore Canyon Boulevard and Eastridge Avenue in reference to a homicide
8 investigation. At approximately 1943 hours, I arrived at the location and met with Riverside
9 Police Department (RPD) homicide unit, and California Highway Patrol (CHP) and Riverside
10 Sheriff (RSO) personnel. I was provided a brief of the incident by Sgt. ██████████ and a partial
11 walk through of the scene. Due to the time of night and lack of visibility, I was advised the scene
12 would remain secured and be processed the following morning. At this time, I cleared the
13 location and was directed by homicide personnel to respond back to this location at 0600 hours
14 on 08/13/2019.

15
16 On 08/13/2019, at approximately 0600 hours, I arrived back at this location and met with RPD
17 homicide personnel. I processed the scene with the assistance of Det. ██████████ and Det. ██████████
18 ██████████
19

20 **Video/Photographs Taken:**

21 On 08/13/2019, at approximately 0617 hours, I recorded video of the scene with the assistance of
22 Det. ██████████. I took 42 photographs of the exterior and interior of the below listed vehicles and
23 their assigned shotguns (see attached chart forms for further information). No firearms were
24 collected from the below listed units during this time.
25

26 **Moreno Valley Police Unit (RSO) 1358192/ CA Exempt**
27 **California Highway Patrol (CHP) Unit 1365174/CA Exempt**



Riverside Police Department

Officer Report

File Number:
190023109-111

28
29 On 08/14/2019, all 42 photographs were uploaded to the secured Digital Information
30 Management System (DIMS).

31
32 On 08/21/2019, at approximately 1500 hours, I removed the video camera from the secured
33 forensic unit vault and uploaded the recorded video of the scene to DIMS.

34 35 Evidence Collection:

36 On 08/13/2019, after recording video of the scene, [REDACTED] and I identified
37 and marked multiple items of evidence with number placards. Due to the extensive nature of the
38 scene, the collection of evidence items occurred between 08/13/2019 and 08/14/2019. I collected
39 evidence items OV002 through OV016, OV016A, OV017 through OV021, OV022A through
40 OV022C, OV023, OV024, OV027 through OV032, OV033A through OV033C, OV034 through
41 OV046, OV048 through OV052, OV054 through OV056, OV059 through OV098, OV100, and
42 REA01 (reference attached evidence logs and property report for further information). Please
43 note evidence item OV016 and OV016A were charted at the scene with the assistance of Det.
44 [REDACTED] (reference chart form for further information). At the direction of Det. [REDACTED] evidence
45 items OV025 and OV026 were released back and secured inside the white GMC truck
46 [REDACTED]

47
48 Evidence items marked as numbers 47, 53, 57, 58, and 99 in photographs were collected by
49 Supervising Forensic Specialist [REDACTED] (reference her report for further information).
50 Evidence item marked as number 1 in photographs was collected by Det. [REDACTED] (reference
51 his report for further information).

52
53 Possible strike marks were located on the exterior front portion of the below listed vehicle and
54 labeled at the scene.

55 56 California Highway Patrol (CHP) Unit 1484455/CA Exempt

57
58 Due to the extensive damage to the vehicle, I stopped labeling the remainder of the possible
59 strike marks at the scene since the vehicle was to be towed to the Magnolia Station for further
60 processing. Please reference [REDACTED] report for further information regarding this vehicle.

61
62 Measurements of the evidence items and scene were scanned and documented by Det. [REDACTED]
63 [REDACTED] using the FARO 3D measurement and imaging scanner (reference his report for
64 further information). Evidence items OV091 through OV093 were located after the scanning
65 process. With the assistance of [REDACTED], measurements were recorded for
66 these items and provided to [REDACTED] for his diagram. Evidence items OV094 through
67 OV099 were located after the scanning process and measurements for these items were
68 inadvertently not recorded. Evidence item OV100 was not measured at the direction of [REDACTED]

69
70



Riverside Police Department

Officer Report

File Number:
190023109-111

71 On 08/14/2019, at approximately 0338 hours, I cleared the scene and transported all evidence
72 directly to Magnolia Station. I arrived at Magnolia Station at approximately 0402 hours, and
73 secured all evidence and video camera inside the forensic unit vault.
74

75 Evidence Disposition:

76 On 08/15/2019, at approximately 1200 hours, I removed evidence items SMI01, KES01,
77 OV022C and OV024 from the secured forensic unit vault. I took 133 photographs of these items.
78 I released OV024 to Det. [REDACTED] at approximately 1350 hours. I separated property from
79 OV022C into sub-letters OV022C-A and OV022C-B. I released evidence items SMI01, KES01,
80 OV022C, OV022C-A, and OV022C-B to Magnolia Station property locker #38 at approximately
81 1540 hours. The photographs were uploaded to DIMS.
82

83 On 08/20/2019, at approximately 0951 hours, I removed evidence items OV018 and OV022A
84 from the secured forensic unit vault. I took 49 photographs of both evidence items. I then
85 separated property from OV018 into sub-letters OV018A and OV018B. I released all items to
86 Magnolia Station property locker #38 at approximately 1238 hours. At approximately 1245
87 hours, I removed evidence items OV008, OV017, OV031, and OV068 from the secured forensic
88 unit vault. I released these items to Magnolia Station property locker #33 at approximately 1353
89 hours. At approximately 1410 hours, I removed evidence items OV019, OV033C, and OV011
90 from the secured forensic unit vault. I took 119 photographs of these items. I released these items
91 to Magnolia Station property locker #37 at approximately 1604 hours. The photographs were
92 uploaded to DIMS.
93

94 On 08/23/2019, at approximately 1113 hours, I removed evidence items OV059, OV060,
95 OV062, OV064, and OV069 from the secured forensic unit vault. I released all items to
96 Magnolia Station property locker #41 at approximately 1307 hours. At approximately 1503
97 hours, I removed evidence items OV041 through OV043, OV046, OV049, OV051, OV055,
98 OV061, OV063, and OV067 from the secured forensic unit vault. I released all these items to
99 Magnolia Station property locker #42 at approximately 1612 hours.
100

101 On 08/26/2019, at approximately 0758 hours, I removed evidence items OV009, OV010, OV012
102 through OV015, OV021, OV022B, OV023, OV027 through OV030, OV032, OV033A, OV034
103 through OV040, OV056, and OV065 from the secured forensic unit vault. I took 14 photographs
104 of items OV022B, OV029, and OV033A. I secured OV022B inside a knife box and retained the
105 original envelope used for collection as OV022B-A. I released these items to Magnolia Station
106 property locker #37 at approximately 1245 hours. At approximately 1400 hours, I removed
107 evidence items OV044, OV045, OV050, OV052, OV054, OV066, OV070 through OV073, and
108 OV075 through OV077 from the secured forensic unit vault. I released these items to Magnolia
109 Station property locker #42 at approximately 1459 hours. The photographs were uploaded to
110 DIMS.
111

112 On 08/27/2019, at approximately 1205 hours, I removed evidence items OV002 through OV007,
113 OV048, OV074, OV078 through OV084, OV091 through OV093, and REA01 from the secured

Date Printed: 10/31/2022 9:32 AM	Case Report Number: 190023109-111	Page: 4 of 5	Ver. 1.3.3
-------------------------------------	--------------------------------------	-----------------	---------------



Riverside Police Department

Officer Report

File Number:
190023109-111

114 forensic unit vault. I released these items to Magnolia Station property locker #37 at
115 approximately 1622 hours.

116
117 On 08/29/2019, at approximately 0830 hours, I removed evidence items OV085 through OV090,
118 OV094 through OV098, and OV100 from the secured forensic unit vault. I released all these
119 items to Magnolia Station property locker #42 at approximately 1218 hours. At approximately
120 1400 hours, I removed evidence item OV033B from the secured forensic unit vault and took nine
121 photographs of the item. During this time, I removed OV016 from the secured forensic unit
122 vault. I created a master copy DVD and working copy DVD from the recorded video of the scene
123 which I labeled and packaged VID01 and VID02. I released VID01 and VID02 to Magnolia
124 Station property locker #43 at approximately 1440 hours, and I released OV016 and OV033B to
125 Police Property Specialist [REDACTED] at approximately 1445 hours. The photographs were
126 uploaded to DIMS.

127
128 Please reference attached chart forms, evidence logs, property report, and additional
129 supplemental reports for further information.

130
131

RIVERSIDE POLICE DEPARTMENT

Date Printed: 10/31/2022 9:32 AM	Case Report Number: 190023109-111	Page: 5 of 5	Ver. 1.3.3
-------------------------------------	--------------------------------------	-----------------	---------------



Riverside Police Department

Officer Report

File Number:
190023109-112

Administrative Information

Subject:	1111 - OFFICER NEEDS BACK-UP/URGENT RESPONSE				
Date(s) and Time(s) of Occurrence Or Between:	8/12/2019 5:38:00 AM //				
Location Of Occurrence:	Box Springs Bldg / Eastridge Ave RIVERSIDE				
Date/Time Reported:	8/12/2019 5:38:06 PM	Day:	Monday		
Date Of Report:	2/20/2020 5:41:25 PM	Type Of Premises:			
NPC:		RD:	PG08	Beat:	3
Was There a Witness To The Crime?					
Can a Suspect Be Named Or Identified?		By Whom?			
Can a Suspect Vehicle Be Identified?		By Whom?			

Code Section Classification:

Records Section

Reporting Officer:	[REDACTED]		
115 Qualified:	Yes		
Send Copies Of This Report To:			
DOJ/NCIC Entered?		Name/ID	
DOJ/NCIC Cancelled?		Name/ID	
APR Sent?		Name/ID	
APB Sent?		Name/ID	

Public Narrative

Supervisor Approving

Approving Supervisor:	[REDACTED]
Date Reviewed:	2/21/2020 12:00:00 AM

Evidence Information

Physical Evidence Present?		Physical Evidence Seized?	
----------------------------	--	---------------------------	--



Riverside Police Department

Officer Report

File Number:
190023109-112

Photographs Taken?		Photographer?	
Weapon Seized?		Weapon(s) Taken For Safety?	
Gang Related?		Sensitive Data?	
Fingerprint Search Made?		Fingerprints Obtained?	
Narcotics Seized?		Narcotics Field Tested?	
Audio Recording Available?		In Car Recording Available?	
Body Worn Camera Recording Available?			
Type of Weapon, Force, Or Device Used?			
Motive:			

Narrative

1 **BACKGROUND:**

2 As part of the UC Riverside Police Department, I am currently assigned to the UNET (University
3 Neighborhood Enhancement Team) and have been since July of 2019. UCR UNET Officers perform all
4 duties required of a UCPD Officer under the direct supervision of both the UCPD Sergeant and
5 Riverside PD Sergeant assigned to the UNET team. UCR UNET Officers are partnered with RPD UNET
6 Officers and assigned to patrol the designated UNET beat within the city of Riverside.

7
8 **NARRATIVE:**

9 On February 20, 2020 I was asked to write a supplemental report clarifying my original supplemental
10 report written on August 12, 2020 regarding my role in this incident. The following are clarifying
11 statements I was asked to elaborate on.

12
13 On the indicated date and time, RPD Officer [REDACTED] #1690 and I were in full police uniform driving a
14 marked black and white Riverside Police patrol vehicle unit 3539. At the time of the call, we
15 responded to the scene from the UNET Office (1201 University Avenue). See Officer [REDACTED]
16 supplemental report for further information regarding our response to the scene and where the
17 vehicle was parked at the scene.

18
19 While responding to the scene, I grabbed my department issued rifle from the rack located inside
20 our patrol vehicle. After we arrived at the scene, I ran up the off ramp from the S/B 215 freeway exit
21 onto Eastridge Avenue with my rifle at a low ready position. While running up the off ramp, I heard
22 several shots being fired from a direction located on Eastridge Avenue, west of my position. I do not
23 recall the number of shots I heard. See my initial supplemental report regarding my actions taken
24 after running up the off ramp.

25
26 After assisting with the extraction of an injured CHP Officer, I then ran to a patrol unit north of my
27 location. In my initial supplemental report I stated "I assisted in covering the officers as they



Riverside Police Department

Officer Report

File Number:
190023109-112

28 approached the suspect who I saw was also down on the ground in front of his vehicle." To clarify, I
29 was "covering" the officers by pointing my rifle in the direction of where the suspect was located in
30 order to address any threats posed to myself, the officers on scene, and civilians in the area. It should
31 be noted I did not fire my weapon at any time during this incident.

32
33 No further information.

34
35

RIVERSIDE POLICE DEPARTMENT

Date Printed: 10/31/2022 9:34 AM	Case Report Number: 190023109-112	Page: 3 of 3	Ver. 1.3.3
-------------------------------------	--------------------------------------	-----------------	---------------



Riverside Police Department

Officer Report

File Number:
190023109-113

Administrative Information

Subject:		1111 - OFFICER NEEDS BACK-UP/URGENT RESPONSE			
Date(s) and Time(s) of Occurrence Or Between:		//			
Location Of Occurrence:		Box Springs Bldg / Eastridge Ave RIVERSIDE			
Date/Time Reported:	8/12/2019 5:38:06 PM	Day:			
Date Of Report:	4/8/2020 12:00:25 PM	Type Of Premises:			
NPC:		RD:	PG08	Beat:	3
Was There a Witness To The Crime?					
Can a Suspect Be Named Or Identified?		By Whom?			
Can a Suspect Vehicle Be Identified?		By Whom?			

Code Section Classification:

Records Section

Reporting Officer:	[REDACTED]				
115 Qualified:	Yes				
Send Copies Of This Report To:					
DOJ/NCIC Entered?		Name/ID			
DOJ/NCIC Cancelled?		Name/ID			
APR Sent?		Name/ID			
APB Sent?		Name/ID			

Public Narrative

Supervisor Approving

Approving Supervisor:	[REDACTED]				
Date Reviewed:	4/8/2020 12:00:00 AM				

Evidence Information

Physical Evidence Present?		Physical Evidence Seized?	
----------------------------	--	---------------------------	--



Riverside Police Department

Officer Report

File Number:
190023109-113

Photographs Taken?		Photographer?	
Weapon Seized?		Weapon(s) Taken For Safety?	
Gang Related?		Sensitive Data?	
Fingerprint Search Made?		Fingerprints Obtained?	
Narcotics Seized?		Narcotics Field Tested?	
Audio Recording Available?		In Car Recording Available?	
Body Worn Camera Recording Available?			
Type of Weapon, Force, Or Device Used?			
Motive:			

Narrative

1 On 02/24/2020 I contacted Sergeant [REDACTED] of the California Highway Patrol (Inland Division);
 2 reference interview transcripts of the CHP Officers interviews being ready for review. Sergeant
 3 [REDACTED] said the officers involved in the OIS would not be reviewing their transcripts for the following
 4 reasons:
 5
 6 -Not common practice for their officers to review transcripts of oral interviews, and
 7 -Due to the emotional tie of the incident, none of the officers ([REDACTED]) would want
 8 to "re-live" the emotions of that day.
 9
 10 I explained to Sergeant [REDACTED] the importance of the officers to review the transcript of their interview
 11 for accuracy, but also understood the officers not willing to expose themselves to the emotions of
 12 that day. After speaking with Sergeant [REDACTED] I played the audio files (related to each individual
 13 officer) and proof-read the transcript of the interview.
 14
 15 At the end of each transcript, I initialed the document on behalf of the respected CHP Officer.
 16
 17 ***A correction was made to Officer [REDACTED] transcript on page 6, line 233. Correction was made from
 18 "Villman Springs" to "Gillman Springs"
 19



Riverside Police Department

Officer Report

File Number:
190023109-114

Administrative Information

Subject:	1111 - OFFICER NEEDS BACK-UP/URGENT RESPONSE				
Date(s) and Time(s) of Occurrence Or Between:	//				
Location Of Occurrence:	Box Springs Bldg / Eastridge Ave RIVERSIDE				
Date/Time Reported:	8/12/2019 5:38:06 PM	Day:			
Date Of Report:	8/10/2020 1:28:20 PM	Type Of Premises:			
NPC:		RD:	PG08	Beat:	3
Was There a Witness To The Crime?					
Can a Suspect Be Named Or Identified?		By Whom?			
Can a Suspect Vehicle Be Identified?		By Whom?			

Code Section Classification:

Records Section

Reporting Officer:	[REDACTED]				
115 Qualified:	Yes				
Send Copies Of This Report To:					
DOJ/NCIC Entered?		Name/ID			
DOJ/NCIC Cancelled?		Name/ID			
APR Sent?		Name/ID			
APB Sent?		Name/ID			

Public Narrative

Supervisor Approving

Approving Supervisor:	[REDACTED]				
Date Reviewed:	8/11/2020 12:00:00 AM				

Evidence Information

Physical Evidence Present?		Physical Evidence Seized?	
----------------------------	--	---------------------------	--



Riverside Police Department

Officer Report

File Number:
190023109-114

Photographs Taken?		Photographer?	
Weapon Seized?		Weapon(s) Taken For Safety?	
Gang Related?		Sensitive Data?	
Fingerprint Search Made?		Fingerprints Obtained?	
Narcotics Seized?		Narcotics Field Tested?	
Audio Recording Available?		In Car Recording Available?	
Body Worn Camera Recording Available?			
Type of Weapon, Force, Or Device Used?			
Motive:			

Narrative

1 On 02/24/2020 I contacted Investigator [REDACTED] (Central Homicide Unit); reference an interview
 2 transcript of Riverside County Sheriff Deputy [REDACTED] being ready for review. Investigator [REDACTED]
 3 said Deputy [REDACTED] had been assigned a "Personal File", and he was no longer allowed to make
 4 contact with Deputy [REDACTED]. Investigator [REDACTED] advised to contact Deputy [REDACTED] legal
 5 representation; [REDACTED]
 6
 7 On 03/25/2020 I called [REDACTED] and left a voice message explaining the process of Deputy
 8 [REDACTED] needing to review the transcript of his OIS interview. A couple days later, I called back and
 9 spoke with [REDACTED] secretary and she explained the law office was closed due to the Corona
 10 Virus pandemic.
 11
 12 On 06/16/2020 I called [REDACTED] but his voicemail was full. On 06/18/2020 I spoke with [REDACTED]
 13 [REDACTED] and he mentioned he would try to get a hold of Deputy [REDACTED] so he could review the
 14 transcript.
 15
 16 On 07/15/2020 I called [REDACTED] again and left a voice message stating the Riverside County
 17 Coroner's Review was scheduled for 07/29/2020, and after the review, I would be submitting the
 18 Case Book to the District Attorney's Office.
 19
 20 After attending the Coroner's Review, I played the audio files (related to Deputy [REDACTED] and proof-
 21 read the transcript of the interview.
 22
 23 At the end of the transcript, I initialed the document on behalf of Deputy [REDACTED]
 24
 25 ***A correction was made to Deputy [REDACTED] transcript on page 14, line 628. Correction was made
 26 from "3:54" to "2:54"
 27



Riverside Police Department

Officer Report

File Number:
190023109-115

Administrative Information

Subject:	1111 - OFFICER NEEDS BACK-UP/URGENT RESPONSE				
Date(s) and Time(s) of Occurrence Or Between:	//				
Location Of Occurrence:	Box Springs Bldg / Eastridge Ave RIVERSIDE				
Date/Time Reported:	8/12/2019 5:38:06 PM	Day:			
Date Of Report:	12/3/2020 5:23:00 PM	Type Of Premises:			
NPC:		RD:	PG08	Beat:	3
Was There a Witness To The Crime?					
Can a Suspect Be Named Or Identified?			By Whom?		
Can a Suspect Vehicle Be Identified?			By Whom?		

Code Section Classification:

Records Section

Reporting Officer:	[REDACTED]		
115 Qualified:	Yes		
Send Copies Of This Report To:			
DOJ/NCIC Entered?		Name/ID	
DOJ/NCIC Cancelled?		Name/ID	
APR Sent?		Name/ID	
APB Sent?		Name/ID	

Public Narrative

Supervisor Approving

Approving Supervisor:	[REDACTED]
Date Reviewed:	12/10/2020 12:00:00 AM

Evidence Information

Physical Evidence Present?		Physical Evidence Seized?	
----------------------------	--	---------------------------	--



Riverside Police Department

Officer Report

File Number:
190023109-115

Photographs Taken?		Photographer?	
Weapon Seized?		Weapon(s) Taken For Safety?	
Gang Related?		Sensitive Data?	
Fingerprint Search Made?		Fingerprints Obtained?	
Narcotics Seized?		Narcotics Field Tested?	
Audio Recording Available?		In Car Recording Available?	
Body Worn Camera Recording Available?			
Type of Weapon, Force, Or Device Used?			
Motive:			

Narrative

1 On 10/03/19 RSO Investigator [REDACTED] and Deputy [REDACTED] responded to the Magnolia Station to
 2 gather his personal belongings from his Moreno Valley Police unit. While conducting an inventory of
 3 his personal belongings, Deputy [REDACTED] requested his personally owned 9mm Springfield magazine
 4 to be returned. I asked Forensic Specialist [REDACTED] and Property Manager [REDACTED] for assistance due to
 5 the large volume of evidence items.
 6
 7 During the evidence log review, we could not locate a 9mm magazine belonging to [REDACTED]. I then
 8 reviewed the color photos and drone footage taken from the scene and located a silhouette of a
 9 magazine lying on top of the trunk of the Moreno Valley PD unit; towards the right rear brake light.
 10
 11 While discussing this situation with Forensic Specialist [REDACTED], Supervisor Forensic Specialist [REDACTED]
 12 [REDACTED], and Investigator [REDACTED] it was determined Deputy [REDACTED] magazine was
 13 left on top of the trunk and most likely fell off the during the towing process to the Magnolia Station
 14 for processing.
 15
 16 Because Deputy [REDACTED] 9mm Springfield magazine was not collected on-scene (most likely due to
 17 fatigue and that portion of the scene getting processed during the second night,) his remaining
 18 rounds of ammunition were not available to be charted.
 19
 20 After the discussion, Investigator [REDACTED] advised the Riverside County Sheriff's Department would
 21 reimburse Deputy [REDACTED] and replace his 9mm Springfield magazine.
 22
 23 NFD
 24



Riverside Police Department

Officer Report

File Number:
190023109-116

Administrative Information

Subject:		1111 - OFFICER NEEDS BACK-UP/URGENT RESPONSE			
Date(s) and Time(s) of Occurrence Or Between:		//			
Location Of Occurrence:		Box Springs Bldg / Eastridge Ave RIVERSIDE			
Date/Time Reported:	8/12/2019 5:38:06 PM	Day:			
Date Of Report:	8/12/2019 10:29:38 PM	Type Of Premises:			
NPC:		RD:	PG08	Beat:	3
Was There a Witness To The Crime?					
Can a Suspect Be Named Or Identified?		By Whom?			
Can a Suspect Vehicle Be Identified?		By Whom?			

Code Section Classification:

Records Section

Reporting Officer:	[REDACTED]				
115 Qualified:	Yes				
Send Copies Of This Report To:					
DOJ/NCIC Entered?		Name/ID			
DOJ/NCIC Cancelled?		Name/ID			
APR Sent?		Name/ID			
APB Sent?		Name/ID			

Public Narrative

See original for further.

Supervisor Approving

Approving Supervisor:	[REDACTED]				
Date Reviewed:	10/6/2021 12:00:00 AM				

Evidence Information

Physical Evidence Present?		Physical Evidence Seized?	
----------------------------	--	---------------------------	--



Riverside Police Department

Officer Report

File Number:
190023109-116

Photographs Taken?		Photographer?	
Weapon Seized?		Weapon(s) Taken For Safety?	
Gang Related?		Sensitive Data?	
Fingerprint Search Made?		Fingerprints Obtained?	
Narcotics Seized?		Narcotics Field Tested?	
Audio Recording Available?		In Car Recording Available?	
Body Worn Camera Recording Available?			
Type of Weapon, Force, Or Device Used?			
Motive:			

Narrative

1 **Evidence:**

2 Department BWC

3

4 **Source:**

5 On Monday, August 12, 2019, at approximately 1738 hours, in the City and County of Riverside,
6 Partner Officer [REDACTED] and I were assigned to work uniformed patrol in a marked black and
7 white police car. At this time, we were dispatched to the area of Box Springs Blvd and Eastridge
8 Avenue, reference an "11-11 shots fired, CHP Motor Officer down." Dispatch further advised
9 the suspect was described as a White male adult wearing sunglasses and armed with an AR-15
10 rifle. I activated my overhead red and blue lights and sirens at the intersection of Chicago
11 Avenue and University Avenue. We drove to the southbound 215 fwy and Eucalyptus/Eastridge
12 Avenue off ramp.

13

14 **Details:**

15 When we arrived to the scene, I parked my vehicle on the Eucalyptus/Eastridge Avenue off ramp
16 using my activated emergency lights to block any vehicles from entering the crime scene. I
17 activated my Department Issued Body-Worn Video System (BVS) and ran to the scene where I
18 found additional officers holding cover for the CHP officer which was lying supine in between
19 the CHP units. Partner Officer [REDACTED] and I, along with other officers on scene, assisted in
20 carrying the downed CHP officer to Unit Air-1 for air transport for medical treatment (Air
21 Medical Evacuation).

22

23 Ofc. [REDACTED] and I located Sgt. [REDACTED] who advised us to preserve the crime scene by placing
24 yellow crime scene tape around the scene. We were later relieved from our duties by Officer [REDACTED]
25 [REDACTED] and his partner per Lt. [REDACTED]

26

27 No further information.



Riverside Police Department Officer Report

File Number:
190023109-116

28

RIVERSIDE POLICE DEPARTMENT

Date Printed: 11/1/2022 2:31 PM	Case Report Number: 190023109-116	Page: 3 of 3	Ver. 1.3.3
------------------------------------	--------------------------------------	-----------------	---------------

190023109

INCIDENT REPORT

DATE PREPARED: 08/19/19 RIVERSIDE COUNTY SHERIFF CA0330000 INITIAL SUPPLEMENTAL

1. FILE NUMBER MC192240003	2. DATE/TIME REPORTED	3. DATE/TIME ASSIGNED	4. DATE/TIME INV. START	5. DATE/TIME INV. TERM	6. ADULT ARR	7. JUV ARR
8. OFFENSES - CODE SECTION Assist Other Department		CRIME No Change	COUNTS 01		9. EDP CODE 25A2N	
10. OFFENSES - CODE SECTION (Add or Change to)		CRIME	COUNTS		11. EDP CODE	
12. OFFENSES - CODE SECTION (Add or Change to)		CRIME	COUNTS		13. EDP CODE	
14. LOCATION OF OCCURRENCE Eastridge Ave. X Box Springs Blvd., Riverside		15. REP. DIST. 900C	16. OCCURRED ON- 08/12/19	DATE/TIME 1737	17. OR BETWEEN DATE/TIME	
18. BUSINESS NAME			19. BUSINESS PHONE		20. CASE STATUS/ CLEARANCE Open/CR-2	
21. WAS THIS INCIDENT RELATED TO MARIJUANA? <input type="checkbox"/> YES <input type="checkbox"/> NO (If yes, briefly include in narrative or additional details how it was related)						

VICTIM - REPORTING PARTY - WITNESS - OTHERS: SEE ADDITIONAL PERSONS REPORT

22. INVL WIT	23. NAME (Last, First, Middle)	24. SEX F	25. RACE W	26. DOB 040275	27. AGE	28. HT	29. WT	30. HAIR	31. EYES	32. SKIN
33. RESIDENCE ADDRESS			CITY	ZIP	34. EMAIL ADDRESS			35. RES. PHONE		
36. BUSINESS ADDRESS			CITY	ZIP	37. EMAIL ADDRESS			38. BUS. PHONE		

39. INVL OTH	40. NAME (Last, First, Middle)	41. SEX F	42. RACE W	43. DOB	44. AGE	45. HT	46. WT	47. HAIR	48. EYES	49. SKIN
50. RESIDENCE ADDRESS			CITY	ZIP	51. EMAIL ADDRESS			52. RES. PHONE		
53. BUSINESS ADDRESS			CITY	ZIP	54. EMAIL ADDRESS			55. BUS. PHONE		

SUSPECT: ADULT JUVENILE PAROLE PROBATION SEE ADDITIONAL PERSONS REPORT ARRESTED

56. SUS# 01	57. NAME (Last, First, Middle) Luther, Aaron	58. SEX M	59. RACE W	60. DOB 032370	61. AGE	62. HT	63. WT	64. HAIR	65. EYES	66. SKIN
67. DRIVER'S LICENSE NUMBER / ID NUMBER		IN POSSESSION YES <input type="checkbox"/> NO <input type="checkbox"/>	68. STATE	69. SOCIAL SECURITY NUMBER		70. MNI NUMBER		71. CII NUMBER		
72. RESIDENCE ADDRESS			CITY	ZIP	73. EMAIL ADDRESS			74. RES. PHONE Unk		
75. BUSINESS ADDRESS			CITY	ZIP	76. EMAIL ADDRESS			77. BUS. PHONE		

78. JUVENILE DISPOSITION OTHER JURIS. JUV. CRT. PROB. WITHIN DEPT. DETAINED NOT DETAINED

79. GANG DATA GANG NAME(S): <input type="checkbox"/> Member <input type="checkbox"/> Associate <input type="checkbox"/> Self-Admit <input type="checkbox"/> Prior Knowledge	80. TATTOOS/SCARS/MARKS/CLOTHING DESCRIPTION
TATTOOS / SCARS / MARKS <input type="checkbox"/> Face <input type="checkbox"/> Neck <input type="checkbox"/> R. Arm <input type="checkbox"/> L. Arm <input type="checkbox"/> Hands <input type="checkbox"/> Torso <input type="checkbox"/> Back <input type="checkbox"/> Legs	

VEHICLE: REFER TO CHP 180 FORM FOR STOLEN, RECOVERED, TOWED OR IMPOUNDED

81. INVL WIT	82. LICENSE 7MYW037	83. STATE CA	84. YEAR 2015	85. MAKE Kia	86. MODEL Optima	87. BODY STYLE 4 door	88. S/L/R/O Code:	AUTO VALUE \$
89. COLOR/COLOR White		90. VIN # 5XXGN4A7XFG497276			91. OTHER IDENTIFIERS		92. DISPOSITION OF VEHICLE	
93. REGISTERED OWNER		94. ADDRESS		CITY	STATE	ZIP	95. PHONE	

PROPERTY REPORT ATTACHED FOR STOLEN, RECOVERED OR DAMAGED PROPERTY 101. DAMAGED PROPERTY VALUE \$

REPORTING OFFICER	OFFICER I.D. 4101	APR SENT	APR CANCELLED	DOJ-NCIC ENTERED	DOJ-NCIC CANCELLED
COPIES TO Riverside PD, Central Homicide Unit		APR SENT 8/21/19		ENTERED BY/DATE 8/23/19	

ADDITIONAL PERSONS REPORT

PAGE

FILE NUMBER
MC192240003

RIVERSIDE COUNTY SHERIFF CA0330000

INITIAL SUPPLEMENTAL

VICTIM - REPORTING PARTY - WITNESS - OTHERS:

1. INVL WIT	2. NAME (Last, First, Middle) [REDACTED]	3. SEX M	4. RACE W	5. DOB [REDACTED]	6. AGE	7. HT	8. WT	9. HAIR	10. EYES	11. SKIN
12. RESIDENCE ADDRESS [REDACTED]		CITY [REDACTED]			ZIP [REDACTED]		13. EMAIL		14. RES. PHONE [REDACTED]	
14. BUSINESS ADDRESS		CITY			ZIP		15. EMAIL		16. BUS. PHONE	

17. INVL WIT	18. NAME (Last, First, Middle) [REDACTED]	19. SEX F	20. RACE W	21. DOB [REDACTED]	22. AGE	23. HT	24. WT	25. HAIR	26. EYES	27. SKIN
28. RESIDENCE ADDRESS [REDACTED]		CITY [REDACTED]			ZIP [REDACTED]		29. EMAIL		30. RES. PHONE [REDACTED]	
31. BUSINESS ADDRESS		CITY			ZIP		32. EMAIL		33. BUS. PHONE	

34. INVL OTH	35. NAME (Last, First, Middle) [REDACTED]	36. SEX	37. RACE	38. DOB	39. AGE	40. HT	41. WT	42. HAIR	43. EYES	44. SKIN
45. RESIDENCE ADDRESS		CITY			ZIP		46. EMAIL		47. RES. PHONE	
48. BUSINESS ADDRESS [REDACTED]		CITY			ZIP		49. EMAIL		50. BUS. PHONE [REDACTED]	

51. INVL	52. NAME (Last, First, Middle)	53. SEX	54. RACE	55. DOB	56. AGE	57. HT	58. WT	59. HAIR	60. EYES	61. SKIN
62. RESIDENCE ADDRESS		CITY			ZIP		63. EMAIL		64. RES. PHONE	
65. BUSINESS ADDRESS		CITY			ZIP		66. EMAIL		67. BUS. PHONE	

68. INVL	69. NAME (Last, First, Middle)	70. SEX	71. RACE	72. DOB	73. AGE	74. HT	75. WT	76. HAIR	77. EYES	78. SKIN
79. RESIDENCE ADDRESS		CITY			ZIP		80. EMAIL		81. RES. PHONE	
82. BUSINESS ADDRESS		CITY			ZIP		83. EMAIL		84. BUS. PHONE	

85. INVL	86. NAME (Last, First, Middle)	87. SEX	88. RACE	89. DOB	90. AGE	91. HT	92. WT	93. HAIR	94. EYES	95. SKIN
96. RESIDENCE ADDRESS		CITY			ZIP		97. EMAIL		98. RES. PHONE	
99. BUSINESS ADDRESS		CITY			ZIP		100. EMAIL		101. BUS. PHONE	

102. INVL	103. NAME (Last, First, Middle)	104. SEX	105. RACE	106. DOB	107. AGE	108. HT	109. WT	110. HAIR	111. EYES	112. SKIN
113. RESIDENCE ADDRESS		CITY			ZIP		114. EMAIL		115. RES. PHONE	
116. BUSINESS ADDRESS		CITY			ZIP		117. EMAIL		118. BUS. PHONE	

119. INVL	120. NAME (Last, First, Middle)	121. SEX	122. RACE	123. DOB	124. AGE	125. HT	126. WT	127. HAIR	128. EYES	129. SKIN
130. RESIDENCE ADDRESS		CITY			ZIP		131. EMAIL		132. RES. PHONE	
133. BUSINESS ADDRESS		CITY			ZIP		134. EMAIL		135. BUS. PHONE	

1 **EVIDENCE:**

2 ITEMS: QUANTITY: DESCRIPTION:
3 01 01 CD containing body worn camera footage of incident and initial
4 interview with [REDACTED]
5

6 The above listed evidence was booked into the Perris Sheriff's station.
7
8

9 **DETAILS:**

10
11 On 08/12/19 at 1742 hours, I responded to the intersection of Eastridge Avenue and Box Ridge
12 Boulevard, in the City of Riverside, in reference to a report of an officer involved shooting.
13 While responding, I heard via the radio that several officers were involved in an active gunfight
14 with a suspect at the above location.
15

16 Upon arrival, I began approaching the scene. I passed several officers and deputies who advised
17 the suspect was "down." I began to assist in clearing and securing the scene.
18

19 I was instructed by Sgt. [REDACTED] on scene to obtain a brief interview with [REDACTED]
20 [REDACTED] had been identified on scene as the wife of the suspected shooter.
21

22 I contacted [REDACTED] at her vehicle on the south side of the intersection near the beginning of
23 the "on ramp" to the southbound I-215. She was seated in the front passenger seat of a 2015, Kia
24 Optima (plate #7MYW037,) and she identified the vehicle as hers. I noticed the front windshield
25 had a hole in it that appeared to have been made by a project near the center and towards the
26 roof.
27

28 [REDACTED] told me her husband Aaron Luther had called her on his cell phone and stated he had
29 been stopped by a California Highway Patrol Officer. He told her he had been stopped because
30 he was the solo occupant of his vehicle and had been traveling in the carpool lane. He also stated
31 his vehicle was being towed because he had no Driver's License. She began driving towards the
32 intersection on the freeway but was several minutes away.
33

34 As she got closer to the intersection, Aaron texted [REDACTED] saying "please hurry I'm sorry."
35 She arrived at the intersection and suddenly began hearing a multitude of "pops," which she
36 identified as gunshots. She drove southbound along through the intersection. As she drove
37 through the intersection, her vehicle was struck by gunfire, which caused the hole in her
38 windshield.
39

40 [REDACTED] saw Aaron and Officers exchanging gunfire and told her children to get down. Inside
41 the vehicle was [REDACTED] She is unsure what exactly
42 transpired after this because the children were screaming and she was trying to have them "get
43 down" inside the vehicle to help shield them from possible gunfire.
44

FILE NUMBER

MC192240003

CONTINUATION PAGE

Page Number: 4

1 [REDACTED] and her children were transported to the Riverside University Health Systems (RUHS)
2 Hospital in Moreno Valley by American Medical Response ambulance. We left the scene at
3 1901 hours and arrived at RUHS at 1914 hours.

4
5 [REDACTED] and her children were shown into an emergency room bed and I waited with them as
6 investigators took control of the investigation.

7
8 During the investigation process, [REDACTED] learned via cell phone news articles that Aaron had
9 been killed on scene. She became extremely upset and demanded to leave the hospital. She was
10 given a business card by a Central Homicide Unit Investigator and she left.

11 I cleared the hospital at 2316 hours.

12
13
14 I am forwarding this report to the Riverside Police Department and the Riverside County
15 Sheriff's Central Homicide Unit.

16
17 **CASE STATUS:** Open/CR-2





Riverside County Sheriff's Department

New Property / Evidence Report

Deputy Name:	SHOWALTER,ANDREW	Deputy ID:	4101	Incident Number:	MC19224000 3
Evidence Barcode:	Date Entered:	Item Description:	Mailing Address:	Tickler will be sent:	Entered By (ID):
2177425 	8/19/2019	Item Description: CD WITH BWC FROM [REDACTED] This item is related to the following SUSPECT: LUTHER, AARON.	[REDACTED]	11/17/2019	4101

190023109

INCIDENT REPORT

DATE PREPARED: 08/19/19 RIVERSIDE COUNTY SHERIFF CA0330000 INITIAL SUPPLEMENTAL

1. FILE NUMBER MC192240003	2. DATE/TIME REPORTED	3. DATE/TIME ASSIGNED	4. DATE/TIME INV. START	5. DATE/TIME INV. TERM	6. ADULT ARR	7. JUV ARR
8. OFFENSES - CODE SECTION Assist Other Department		CRIME No Change		COUNTS 01	9. EDP CODE 25A2N	
10. OFFENSES - CODE SECTION (Add or Change to)		CRIME		COUNTS	11. EDP CODE	
12. OFFENSES - CODE SECTION (Add or Change to)		CRIME		COUNTS	13. EDP CODE	
14. LOCATION OF OCCURRENCE Eastridge Ave. X Box Springs Blvd., Riverside			15. REP. DIST. 900C	16. OCCURRED ON- DATE/TIME 08/12/19 1737	17. OR BETWEEN DATE/TIME	
18. BUSINESS NAME			19. BUSINESS PHONE		20. CASE STATUS/ CLEARANCE Open/CR-2	
21. WAS THIS INCIDENT RELATED TO MARIJUANA? <input type="checkbox"/> YES <input type="checkbox"/> NO (If yes, briefly include in narrative or additional details how it was related)						

VICTIM - REPORTING PARTY - WITNESS - OTHERS: SEE ADDITIONAL PERSONS REPORT

22. INVL WIT	23. NAME (Last, First, Middle)	24. SEX F	25. RACE W	26. DOB 040275	27. AGE	28. HT	29. WT	30. HAIR	31. EYES	32. SKIN
33. RESIDENCE ADDRESS			CITY	ZIP	34. EMAIL ADDRESS			35. RES. PHONE		
36. BUSINESS ADDRESS			CITY	ZIP	37. EMAIL ADDRESS			38. BUS. PHONE		

39. INVL OTH	40. NAME (Last, First, Middle)	41. SEX F	42. RACE W	43. DOB	44. AGE	45. HT	46. WT	47. HAIR	48. EYES	49. SKIN
50. RESIDENCE ADDRESS			CITY	ZIP	51. EMAIL ADDRESS			52. RES. PHONE		
53. BUSINESS ADDRESS			CITY	ZIP	54. EMAIL ADDRESS			55. BUS. PHONE		

SUSPECT: ADULT JUVENILE PAROLE PROBATION SEE ADDITIONAL PERSONS REPORT ARRESTED

56. SUS# 01	57. NAME (Last, First, Middle) Luther, Aaron	58. SEX M	59. RACE W	60. DOB 032370	61. AGE	62. HT	63. WT	64. HAIR	65. EYES	66. SKIN
67. DRIVER'S LICENSE NUMBER / ID NUMBER		IN POSSESSION YES <input type="checkbox"/> NO <input type="checkbox"/>	68. STATE	69. SOCIAL SECURITY NUMBER		70. MNI NUMBER		71. CII NUMBER		
72. RESIDENCE ADDRESS			CITY	ZIP	73. EMAIL ADDRESS			74. RES. PHONE Unk		
75. BUSINESS ADDRESS			CITY	ZIP	76. EMAIL ADDRESS			77. BUS. PHONE		

78. JUVENILE DISPOSITION <input type="checkbox"/> OTHER JURIS. <input type="checkbox"/> JUV. CRT. PROB. <input type="checkbox"/> WITHIN DEPT. <input type="checkbox"/> DETAINED <input type="checkbox"/> NOT DETAINED										
79. GANG DATA					80. TATTOOS/SCARS/MARKS/CLOTHING DESCRIPTION					
GANG NAME(S):										
<input type="checkbox"/> Member <input type="checkbox"/> Associate <input type="checkbox"/> Self-Admit <input type="checkbox"/> Prior Knowledge TATTOOS / SCARS / MARKS <input type="checkbox"/> Face <input type="checkbox"/> Neck <input type="checkbox"/> R. Arm <input type="checkbox"/> L. Arm <input type="checkbox"/> Hands <input type="checkbox"/> Torso <input type="checkbox"/> Back <input type="checkbox"/> Legs										

VEHICLE: REFER TO CHP 180 FORM FOR STOLEN, RECOVERED, TOWED OR IMPOUNDED

81. INVL WIT	82. LICENSE 7MYW037	83. STATE CA	84. YEAR 2015	85. MAKE Kia	86. MODEL Optima	87. BODY STYLE 4 door	88. S/L/R/O Code:	AUTO VALUE \$
89. COLOR/COLOR White		90. VIN # 5XXGN4A7XFG497276			91. OTHER IDENTIFIERS		92. DISPOSITION OF VEHICLE	
93. REGISTERED OWNER		94. ADDRESS		CITY	STATE	ZIP	95. PHONE	

PROPERTY REPORT ATTACHED FOR STOLEN, RECOVERED OR DAMAGED PROPERTY 101. DAMAGED PROPERTY VALUE \$

REPORTING OFFICER Showalter	OFFICER I.D. 4101	REVIEWED BY/DATE <i>De Castro 8/23/19</i>	ENTERED BY/DATE	ENTERED BY/DATE
COPIES TO Riverside PD, Central Homicide Unit		8/21/19	APR SENT	APR CANCELLED
		DOJ-NCIC ENTERED	DOJ-NCIC CANCELLED	

ADDITIONAL PERSONS REPORT

PAGE

FILE NUMBER

MC192240003

RIVERSIDE COUNTY SHERIFF CA0330000

INITIAL

SUPPLEMENTAL

VICTIM - REPORTING PARTY - WITNESS - OTHERS:

1. INVL WIT	2. NAME (Last, First, Middle) Luther, Jai	3. SEX M	4. RACE W	5. DOB 113008	6. AGE	7. HT	8. WT	9. HAIR	10. EYES	11. SKIN
12. RESIDENCE ADDRESS 1105 Edgar Ave.		CITY Beaumont		ZIP 92223		13. EMAIL			14. RES. PHONE 6267717398	
14. BUSINESS ADDRESS		CITY		ZIP		15. EMAIL			16. BUS. PHONE	

17. INVL WIT	18. NAME (Last, First, Middle) Taylor, Prudence	19. SEX F	20. RACE W	21. DOB 111716	22. AGE	23. HT	24. WT	25. HAIR	26. EYES	27. SKIN
28. RESIDENCE ADDRESS 1105 Edgar Ave.		CITY Beaumont		ZIP 92223		29. EMAIL			30. RES. PHONE 6267717398	
31. BUSINESS ADDRESS		CITY		ZIP		32. EMAIL			33. BUS. PHONE	

34. INVL OTH	35. NAME (Last, First, Middle) Sgt. J. Adams #3220	36. SEX	37. RACE	38. DOB	39. AGE	40. HT	41. WT	42. HAIR	43. EYES	44. SKIN
45. RESIDENCE ADDRESS		CITY		ZIP		46. EMAIL			47. RES. PHONE	
48. BUSINESS ADDRESS 137 N. Perris Blvd.		CITY Perris		ZIP 92570		49. EMAIL			50. BUS. PHONE 951 210 1000	

51. INVL	52. NAME (Last, First, Middle)	53. SEX	54. RACE	55. DOB	56. AGE	57. HT	58. WT	59. HAIR	60. EYES	61. SKIN
62. RESIDENCE ADDRESS		CITY		ZIP		63. EMAIL			64. RES. PHONE	
65. BUSINESS ADDRESS		CITY		ZIP		66. EMAIL			67. BUS. PHONE	

68. INVL	69. NAME (Last, First, Middle)	70. SEX	71. RACE	72. DOB	73. AGE	74. HT	75. WT	76. HAIR	77. EYES	78. SKIN
79. RESIDENCE ADDRESS		CITY		ZIP		80. EMAIL			81. RES. PHONE	
82. BUSINESS ADDRESS		CITY		ZIP		83. EMAIL			84. BUS. PHONE	

85. INVL	86. NAME (Last, First, Middle)	87. SEX	88. RACE	89. DOB	90. AGE	91. HT	92. WT	93. HAIR	94. EYES	95. SKIN
96. RESIDENCE ADDRESS		CITY		ZIP		97. EMAIL			98. RES. PHONE	
99. BUSINESS ADDRESS		CITY		ZIP		100. EMAIL			101. BUS. PHONE	

102. INVL	103. NAME (Last, First, Middle)	104. SEX	105. RACE	106. DOB	107. AGE	108. HT	109. WT	110. HAIR	111. EYES	112. SKIN
113. RESIDENCE ADDRESS		CITY		ZIP		114. EMAIL			115. RES. PHONE	
116. BUSINESS ADDRESS		CITY		ZIP		117. EMAIL			118. BUS. PHONE	

119. INVL	120. NAME (Last, First, Middle)	121. SEX	122. RACE	123. DOB	124. AGE	125. HT	126. WT	127. HAIR	128. EYES	129. SKIN
130. RESIDENCE ADDRESS		CITY		ZIP		131. EMAIL			132. RES. PHONE	
133. BUSINESS ADDRESS		CITY		ZIP		134. EMAIL			135. BUS. PHONE	

EVIDENCE:

1
2 ITEMS: QUANTITY: DESCRIPTION:
3 01 01 CD containing body worn camera footage of incident and initial
4 interview with McKenzie Luther.
5

6 The above listed evidence was booked into the Perris Sheriff's station.
7
8

DETAILS:

9
10
11 On 08/12/19 at 1742 hours, I responded to the intersection of Eastridge Avenue and Box Ridge
12 Boulevard, in the City of Riverside, in reference to a report of an officer involved shooting.
13 While responding, I heard via the radio that several officers were involved in an active gunfight
14 with a suspect at the above location.
15

16 Upon arrival, I began approaching the scene. I passed several officers and deputies who advised
17 the suspect was "down." I began to assist in clearing and securing the scene.
18

19 I was instructed by Sgt. Adams on scene to obtain a brief interview with McKenzie Luther.
20 McKenzie had been identified on scene as the wife of the suspected shooter.
21

22 I contacted McKenzie at her vehicle on the south side of the intersection near the beginning of
23 the "on ramp" to the southbound I-215. She was seated in the front passenger seat of a 2015, Kia
24 Optima (plate #7MYW037,) and she identified the vehicle as hers. I noticed the front windshield
25 had a hole in it that appeared to have been made by a project near the center and towards the
26 roof.
27

28 McKenzie told me her husband Aaron Luther had called her on his cell phone and stated he had
29 been stopped by a California Highway Patrol Officer. He told her he had been stopped because
30 he was the solo occupant of his vehicle and had been traveling in the carpool lane. He also stated
31 his vehicle was being towed because he had no Driver's License. She began driving towards the
32 intersection on the freeway but was several minutes away.
33

34 As she got closer to the intersection, Aaron texted McKenzie saying "please hurry I'm sorry."
35 She arrived at the intersection and suddenly began hearing a multitude of "pops," which she
36 identified as gunshots. She drove southbound along through the intersection. As she drove
37 through the intersection, her vehicle was struck by gunfire, which caused the hole in her
38 windshield.
39

40 McKenzie saw Aaron and Officers exchanging gunfire and told her children to get down. Inside
41 the vehicle was Eva Luther, Jai Luther, and Prudence Taylor. She is unsure what exactly
42 transpired after this because the children were screaming and she was trying to have them "get
43 down" inside the vehicle to help shield them from possible gunfire.
44

1 McKenzie and her children were transported to the Riverside University Health Systems (RUHS)
2 Hospital in Moreno Valley by American Medical Response ambulance. We left the scene at
3 1901 hours and arrived at RUHS at 1914 hours.

4
5 McKenzie and her children were shown into an emergency room bed and I waited with them as
6 investigators took control of the investigation.

7
8 During the investigation process, McKenzie learned via cell phone news articles that Aaron had
9 been killed on scene. She became extremely upset and demanded to leave the hospital. She was
10 given a business card by a Central Homicide Unit Investigator and she left.

11 I cleared the hospital at 2316 hours.

12
13
14 I am forwarding this report to the Riverside Police Department and the Riverside County
15 Sheriff's Central Homicide Unit.

16
17 **CASE STATUS:** Open/CR-2





Riverside County Sheriff's Department

New Property / Evidence Report

Deputy Name:	SHOWALTER,ANDREW	Deputy ID:	4101	Incident Number:	MC19224000 3
Evidence Barcode:	Date Entered:	Item Description:	Mailing Address:	Tickler will be sent:	Entered By (ID):
2177425 	8/19/2019	Item Description: CD WITH BWC FROM SHOWALTER. This item is related to the following SUSPECT: LUTHER, AARON.	1105 EDGAR AVE BEAUMONT	11/17/2019	4101

**Riverside Police Department
PROPERTY REPORT**

File No.
190023109

Date/Time
08/12/19 -05:38

Type of Complaint 187 - MURDER		Address Box Springs/ Eastridge Ave			
Victim [REDACTED]	DOB	Sex M	Race White	Address	
Arrestee / Suspect	DOB	Sex	Race	Address	
Arrestee / Suspect	DOB	Sex	Race	Address	
Arrestee / Suspect	DOB	Sex	Race	Address	
Finder [REDACTED]	DOB	Sex M	Race White	Address 10540 Magnolia Ave - Riversi	Phone No.
[REDACTED]	Supvr. Approving	RMC/RSC Case No.			Property Clerk

Item	Owner	Itemize, Describe, List Serial Numbers... Only 1 Article per line	Prop. Loc.	Rel. Dispo
OV016B		(1) Control and (1) sample swab of possible blood from right side of stock (#1)	19187030	
OV016C		(1) Control and (1) sample swab of possible blood from right side of pistol grip (#2)	19187030	
OV016D		(1) Control and (1) sample swab of possible blood from right side of handguard (#3)	19187030	
OV016E		(1) Wet and (1) dry sample swab of possible DNA from stock / Possible blood	19187030	
OV016F		(1) Wet and (1) dry sample swab of possible DNA from pistol grips / Possible blood	19187030	
OV016G		(1) Wet and (1) dry sample swab of possible DNA from trigger/trigger guard / Possible blood	19187030	
OV016H		(1) Wet and (1) dry sample swab of possible DNA from tripod	19187030	
OV016I		(1) Sample swab of sterile collection water	19187030	

* Last Item *

**Riverside Police Department
PROPERTY REPORT**

File No.
190023109

Date/Time
08/12/19 -05:38

Type of Complaint 187 - MURDER		Address Box Springs/ Eastridge Ave			
Victim [REDACTED]	DOB	Sex M	Race White	Address	
Arrestee / Suspect	DOB	Sex	Race	Address	
Arrestee / Suspect	DOB	Sex	Race	Address	
Arrestee / Suspect	DOB	Sex	Race	Address	
Finder [REDACTED]	DOB	Sex M	Race White	Address 10540 Magnolia Ave - Riverside	Phone No.
By Officer(s) [REDACTED]	ID No. [REDACTED]	Supvr. Approving	RMC/RSC Case No.		Property Clerk

Item	Owner	Itemize, Describe, List Serial Numbers... Only 1 Article per line	Prop. Loc.	Rel. Dispo
GMC01		(1) CONTROL & (1) SAMPLE SWAB OF POSSIBLE BLOOD- FROM MIDDLE FRONT OF EXTERIOR FRONT HOOD	RET	
GMC02		LIVE "PSD 1 5" CARTRIDGE (POSSIBLE .223/5.56 CALIBER) WITH GREEN TIP- FROM DRIVER DOOR PANEL CUP HOLDER	RET	
GMC03		"7-ELEVEN" RECEIPT DATED 8/12/2019- FROM FRONT PASSENGER FLOOR BOARD	RET	
GMC04		KEY RING WITH MULTIPLE KEYS- FROM FRONT PASSENGER FLOOR BOARD	RET	
GMC05		"USA GAS" RECEIPT DATED 8/12/2019- FROM DRIVER FLOOR BOARD	RET	
GMC06		UNOPENED MAIL ADDRESSED TO "AARON N. LUTHER"- FROM REAR POUCH OF DRIVER SEAT	RET	
GMC07		JACKETED PROJECTILE FRAGMENT (POSSIBLE COPPER/LEAD)- FROM INTERIOR OF DRIVER SEAT BACK	RET	
GMC08		POSSIBLE PROJECTILE FRAGMENT (POSSIBLE LEAD)- FROM STRIKE MARK "O", INTERIOR OF FRONT PASSENGER DOOR	RET	
GMC09		CALIFORNIA ID CARD (EXPIRED), NOTICE TO APPEAR, VEHICLE REGISTRATION, AND NOTICE OF STORED VEHICLE DOCUMENTS FOR "AARON LUTHER"- FROM GOLF BAG POUCH IN TRUCK BED	RET	
GMC10		(1) WET & (1) DRY SAMPLE SWAB OF POSSIBLE DNA- FROM STEERING WHEEL	RET	
GMC11		(1) SAMPLE SWAB OF STERILE COLLECTION WATER- FOR GMC SAMPLES	RET	

* Last Item *

CSU

CALL-OUT REQUEST

Date B-20-19 Time 0750 Agency and Report # Riv P.D. # 190023109

Person Making Request [REDACTED] Call Back Number (951) 353-7160

Details and Special Instructions TO CONDUCT A SECONDARY SEARCH OF THE SCENE FOR THE CHP HELMET BADGE/SHIELD MISSING FROM THE VICTIM OFFICER'S HELMET. THE AREA OF SEARCH IS EASTRIDGE ST/OVERPASS.

Person to Contact at Scene JOENE Not Secured

Staging Area / Assigned Assembly Point WHERE SAFE

CSU Members Assigned and Response Time	Team Leader	R/T
<u>[REDACTED]</u>	<u>[REDACTED]</u>	<u>N/A</u>
<u>[REDACTED]</u>	<u>[REDACTED]</u>	<u>R/T</u>
<u>[REDACTED]</u>	<u>[REDACTED]</u>	<u>R/T</u>
<u>[REDACTED]</u>	<u>[REDACTED]</u>	<u>R/T</u>

Call Back To Requesting Official _____

Team Arrival Time at Location. 0815

Briefing by Crime Scene Officer PRIMARY OBJECTIVE OF SEARCH IS TO LOCATE THE HELMET SHIELD SO THAT IT COULD BE PRESENTED BY LE. TO VICTIM'S FAMILY.

Team Entry to Scene 0815

Assignments and Potential Targets Located:

- -REFER TO NARRATIVE-
- _____
- _____
- _____
- _____
- _____

Advisement of Results to Crime Scene Officer at 0910

Release From Scene by [REDACTED] at 1000

Team Leader Reporting GEORGE CALLOW

ON 8-19-19, I WAS CONTACTED AT HOME, VIA PHONE, BY SUPERVISING FORENSICS SPECIALIST [REDACTED] WHO ADVISED THE HELMET BADGE/SHIELD OF OFFICER MOYE'S CHP MOTOR HELMET WAS MISSING AND PRESUMED LOST AT THE SCENE OF THE SHOOTING. I HE REQUESTED THAT THE RTIC CSU RESPOND ON 8-20-19 AND CONDUCT A SCAN OF THE BRUSH EXTENDING ALONG EASTRIDGE AT THE POINT OF THE SHOOTING.

HAVING BEEN AT THE SCENE ON 8-13-19, I WAS FAMILIAR WITH THE LOCATION INDICATED AS WELL AS THE BRUSH AND WEED OVERGROWTH PRESENT ALONG SIDE THE ROADWAY & SIDEWALK OF EASTRIDGE NEAR THE OVERPASS.

ON 8-13-19, THE RTIC CSU TEAM, AS PART OF THEIR ASSISTANCE TO RPD ON THIS CASE, SEARCHED THE BRUSH AREA FOR SOME DISTANCE EXTENDING TOWARD SYCAMORE CANYON BLVD, AWAY FROM THE AREA NEAR THE SUSP WHITE GMC P/U, AS DIRECTED BY SCENE PERSONNEL, LOOKING AND SCANNING FOR SHELL CASINGS. (REFER TO ORIGINAL RTIC REPORT FOR DETAILS). THIS SEARCH STOPPED AT A POINT NEAR THE SIDEWALK WHERE A LARGE UTILITY ACCESS COVER EXISTS. THE SEARCH CONDUCTED TODAY, 8-20-19, INITIATED BY THE UTILITY ACCESS COVER AND EXTENDED TO THE OVERPASS.

[REDACTED] BEGAN HIS SEARCH NEAR THE ACCESS PANEL IN THE BRUSH WHILE I BEGAN AT THE OPPOSITE END NEAR THE OVERPASS AND WE STARTED MOVING TOWARD EACH OTHER.

MINUTES INTO THE SEARCH, [REDACTED] LOCATED THE HELMET BADGE/SHIELD, LYING AMONGST THE WEEDS, APPROX 4'

Team Leader Reporting (George Callow)

IN FROM THE SIDEWALK. HE PHOTOGRAPHED IT IN PLACE PRIOR TO RECOVERING IT.

AT APPROX. 0910 HRS, I NOTIFIED SE.FORENSICS SPECIALIST [REDACTED] THAT THE HELMET PIECE HAD BEEN RECOVERED. SHE ADVISED THAT SHE WOULD BE ENROUTE TO TAKE POSSESSION OF IT.

UPON HER ARRIVAL, ROW WILSON PLACED A MARKER NEAR WHERE HE RECOVERED THE HELMET BARGE AND [REDACTED] PHOTOGRAPHED THE AREA FROM SEVERAL DIFFERENT POSITIONS.

WE WERE CHARGED TO LEAVE AT APPROX 1000 HRS.

[REDACTED]

END OF REPORT

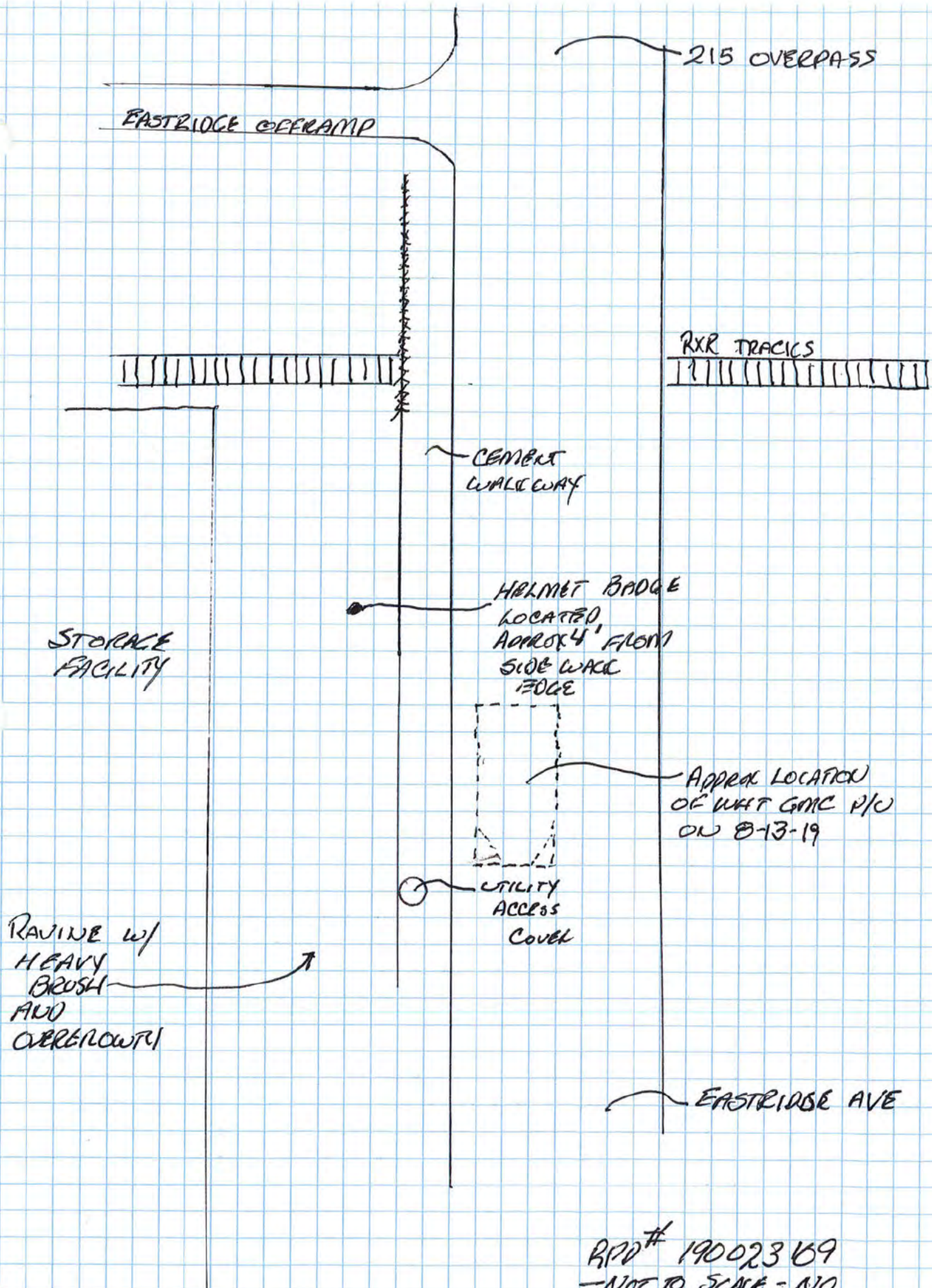

RPD# 190023169
 -NOT TO SCALE - NO
 MEASUREMENTS TAKEN
 SKETCH FOR REFERENCE
 ONLY.

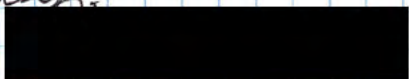

PHOTO BY [REDACTED] PERIOR
TO RECOVERY

PAGE 5 of 5
RPD # 190023109



**Riverside Police Department
PROPERTY REPORT**

File No.
190023109

Date/Time
08/12/19 -05:38

Type of Complaint 187 - MURDER		Address Box Springs/ Eastridge Ave			
Victim [REDACTED]	DOB	Sex M	Race White	Address	
Arrestee / Suspect	DOB	Sex	Race	Address	
Arrestee / Suspect	DOB	Sex	Race	Address	
Arrestee / Suspect	DOB	Sex	Race	Address	
Finder [REDACTED]	DOB	Sex M	Race White	Address 10540 Magnolia Ave - Riverside	Phone No.
E [REDACTED]	Supvr. Approving	RMC/RSC Case No.			Property Clerk

Item	Owner	Itemize, Describe, List Serial Numbers... Only 1 Article per line	Prop. Loc.	Rel. Dispo
BMD01		PROJECTILE FRAGMENT (POSSIBLE COPPER)- FROM STRAP OF ITEM #WEAP01 REMOVED FROM CHP UNIT #4455	RET	
BMD02		JACKETED PROJECTILE AND FRAGMENT (POSSIBLE COPPER/LEAD)- FROM EXTERIOR REAR BUMPER, PASSENGER SIDE OF CHP UNIT #4455	RET	
BMD03		JACKETED PROJECTILE (POSSIBLE COPPER/LEAD)- FROM TRUNK ON TOP OF "STINGER" SPIKE STRIP BOX OF CHP UNIT #4455	RET	
BMD04		JACKETED PROJECTILE (POSSIBLE COPPER/LEAD) - FROM TRUNK MIDDLE PULL-OUT TRAY OF CHP UNIT #4455	RET	
BMD05		PROJECTILE FRAGMENT (POSSIBLE COPPER)- FROM FRONT DRIVERSIDE FENDER WELL OF CHP UNIT #4455	RET	
BMD06		PROJECTILE FRAGMENTS (POSSIBLE LEAD)- FROM STRIKE MARK "L" ON FRONT DRIVERSIDE EXTERIOR BUMPER OF CHP UNIT #4455	RET	
BMD07		PROJECTILE FRAGMENTS (POSSIBLE COPPER/LEAD)- FROM REAR DRIVER SIDE DOOR ARM REST OF CHP UNIT #4455	RET	
BMD08		PROJECTILE FRAGMENTS (POSSIBLE COPPER/LEAD)- FROM REAR MIDDLE SEAT OF CHP UNIT #4455	RET	
BMD09		PROJECTILE FRAGMENT (POSSIBLE COPPER)- FROM STRIKE MARK "I-XX" TO TRUNK TOP WOOD TRAY OF CHP UNIT #4455	RET	
BMD10		PROJECTILE FRAGMENT (POSSIBLE LEAD)- FROM FRONT PASSENGER SEAT BACK OF CHP UNIT #4455	RET	
BMD11		PROJECTILE FRAGMENT (POSSIBLE LEAD)- FROM UNDERNEATH FRONT PASSENGER SEAT OF CHP UNIT #4455	RET	
BMD12		PROJECTILE FRAGMENT (POSSIBLE LEAD)- FROM DRIVER SIDE OF TRUNK AREA HEADLINER OF CHP UNIT #4455	RET	
BMD13		PROJECTILE FRAGMENTS (POSSIBLE COPPER)- FROM TRUNK FLOOR (SPARE TIRE COVER) OF CHP UNIT #4455	RET	
BMD14		JACKETED PROJECTILE (POSSIBLE COPPER/LEAD)- FROM TRUNK 3RD/BOTTOM PULL-OUT TRAY OF CHP UNIT #4455	RET	
BMD15		PROJECTILE FRAGMENT (POSSIBLE COPPER)- FROM UNDERCARRIAGE COVER FOR EVAP CANNISTER OF CHP UNIT #4455	RET	
BMD16		PROJECTILE FRAGMENTS (POSSIBLE LEAD)- FROM INTERIOR SIDE OF REAR PASSENGER RIM/WHEEL OF CHP UNIT #4455	RET	
BMD17		PROJECTILE FRAGMENT (POSSIBLE COPPER)- FROM DRIVER FRONT FENDER WELL OF CHP UNIT #4455	RET	
BMD18		PROJECTILE FRAGMENT (POSSIBLE COPPER)- FROM STRIKE MARK "JJJJ" TO UNDERCARRIAGE PASSENGER SIDE FUEL TANK OF CHP UNIT #4455	RET	

**Riverside Police Department
PROPERTY REPORT**

File No.
190023109

Date/Time
08/12/19 -05:38

Type of Complaint 187 - MURDER		Address Box Springs/ Eastridge Ave			
Arrestee / Suspect	DOB	Sex	Race	Address	
Arrestee / Suspect	DOB	Sex	Race	Address	
Finder	DOB	Sex M	Race White	Address 10540 Magnolia Ave - Riverside	Phone No.

Item	Owner	Itemize, Describe, List Serial Numbers... Only 1 Article per line	Prop. Loc.	Rel. Dispo
BMD19		PROJECTILE FRAGMENT (POSSIBLE LEAD)- FROM DRIVER SIDE UNDERCARRIAGE EXHAUST PIPE OF CHP UNIT #4455	RET	
BMD20		JACKETED PROJECTILE AND FRAGMENTS (POSSIBLE COPPER/LEAD)- FROM PASSENGER SIDE EXHAUST PIPE OF CHP UNIT #4455	RET	
BMD21		PROJECTILE FRAGMENTS (POSSIBLE COPPER)- FROM STRIKE MARK "CCCC" TO UNDERCARRIAGE PASSENGER SIDE REAR UNIBODY OF CHP UNIT #4455	RET	
BMD22		PROJECTILE FRAGMENTS (POSSIBLE COPPER)- FROM STRIKE MARK "DDDD" TO UNDERCARRIAGE PASSENGER SIDE REAR UNIBODY OF CHP UNIT #4455	RET	
BMD23		POSSIBLE PROJECTILE FRAGMENT- FROM LOWER FRONT BUMPER BEHIND GRILL OF CHP UNIT #4455	RET	
BMD24		PROJECTILE FRAGMENT (POSSIBLE COPPER)- FROM STRIKE MARK "Q3" TO LOWER FRONT WINDSHIELD COWL PANEL OF CHP UNIT #4455	RET	
BMD25		PROJECTILE FRAGMENT (POSSIBLE LEAD)- FROM STRIKE MARK "Q2" TO STRUT TOWER BRACE OF CHP UNIT #4455	RET	
BMD26		PROJECTILE FRAGMENTS (POSSIBLE COPPER)- FROM STRIKE MARK "K4" TO DRIVERSIDE UPPER COWL PANEL OF CHP UNIT #4455	RET	
BMD27		JACKETED PROJECTILE AND FRAGMENT (POSSIBLE COPPER/LEAD)- FROM STRIKE MARK "Y" TO ROOF LIGHT BAR OF CHP UNIT #4455	RET	
BMD28		PROJECTILE FRAGMENT (POSSIBLE COPPER)- FROM STRIKE MARK "T" TO ROOF LIGHT BAR OF CHP UNIT #4455	RET	
BMD29		PROJECTILE FRAGMENT (POSSIBLE COPPER)- FROM BEHIND FRONT PASSENGER SEAT OF CHP UNIT #4455	RET	
BMD30		POSSIBLE PROJECTILE FRAGMENTS (POSSIBLE LEAD)- FROM FRONT PASSENGER ROOF HEADLINER OF CHP UNIT #4455	RET	
BMD31		PROJECTILE FRAGMENT (POSSIBLE COPPER)- FROM STRIKE MARK "I-MM" TO FRONT CABIN SIDE OF FOAM ROLL BAR OF CHP UNIT #4455	RET	
BMD32		PROJECTILE FRAGMENT (POSSIBLE LEAD)- FROM STRIKE MARK "I-YY 1" TO INTERIOR (ROOF SIDE) OF HEADLINER ABOVE GATE OF CHP UNIT #4455	RET	
BMD33		PROJECTILE FRAGMENTS (POSSIBLE COPPER)- FROM INTERIOR (ROOF SIDE) OF HEADLINER FRONT PASSENGER SIDE OF CHP UNIT #4455	RET	
BMD34		PROJECTILE FRAGMENT (POSSIBLE COPPER)- FROM STRIKE MARK "I-II" TO REAR PASSENGER SIDE ROOF HEADLINER OF CHP UNIT #4455	RET	
BMD35		PROJECTILE FRAGMENT (POSSIBLE COPPER)- FROM STRIKE MARK "I-NN" TO DRIVER SIDE OF CAGE FRAME OF CHP UNIT #4455	RET	
BMD36		PROJECTILE FRAGMENT (POSSIBLE COPPER)- FROM STRIKE MARK "I-K" TO FRONT PASSENGER SIDE OF FOAM ROLL BAR OF CHP UNIT #4455	RET	
BMD37		PROJECTILE FRAGMENT (POSSIBLE LEAD)- FROM STRIKE MARK "I-W" TO REAR DRIVER SIDE PASSENGER SEAT BACK OF CHP UNIT #4455	RET	
BMD38		PROJECTILE FRAGMENT (POSSIBLE LEAD)- FROM STRIKE MARK "I-LL" TO ROOF HEADLINER ABOVE FRONT PASSENGER SEAT OF CHP UNIT #4455	RET	
BMD39		PROJECTILE FRAGMENT (POSSIBLE LEAD)- FROM REAR DRIVER SIDE INTERIOR LOWER BUMPER COVER AREA OF CHP UNIT #4455	RET	

**Riverside Police Department
PROPERTY REPORT**

File No.
190023109

Date/Time
08/12/19 -05:38

Type of Complaint 187 - MURDER		Address Box Springs/ Eastridge Ave			
Arrestee / Suspect	DOB	Sex	Race	Address	
Arrestee / Suspect	DOB	Sex	Race	Address	
Finder	DOB	Sex M	Race White	Address 10540 Magnolia Ave - Riverside	Phone No.

Item	Owner	Itemize, Describe, List Serial Numbers... Only 1 Article per line	Prop. Loc.	Rel. Dispo
BMD40		JACKETED PROJECTILE AND FRAGMENTS (POSSIBLE COPPER/LEAD)- FROM REAR DRIVER SIDE INTERIOR LOWER BUMPER COVER BEHIND VENT OF CHP UNIT #4455	RET	
BMD41		JACKETED PROJECTILE (POSSIBLE COPPER/LEAD)- FROM STRIKE MARK "I-EEE" TO INTERIOR OF REAR DRIVER SIDE SEAT BACK OF CHP UNIT #4455	RET	
BMD42		JACKETED PROJECTILE (POSSIBLE COPPER/LEAD)- FROM STRIKE MARK "LL" TO REAR DRIVER SIDE TAIL LIGHT OF CHP UNIT #4455	RET	
BMD43		PROJECTILE FRAGMENTS (POSSIBLE COPPER)- FROM TRUNK WOODEN TOP TRAY OF CHP UNIT #4455	RET	
BMD44		PROJECTILE FRAGMENT (POSSIBLE COPPER)- FROM STRIKE MARK "I-GGG" TO YELLOW EMERGENCY BLANKET PACKAGE FROM TRUNK TOP WOODEN TRAY OF CHP UNIT #4455	RET	
BMD45		PROJECTILE FRAGMENTS (POSSIBLE COPPER)- FROM BEHIND REAR PASSENGER SEAT OF CHP UNIT #4455	RET	
BMD46		PROJECTILE FRAGMENT (POSSIBLE LEAD)- FROM CREVICE BETWEEN REAR GRILL/GATE AND TRUNK RACKS OF CHP UNIT #4455	RET	
BMD47		PROJECTILE FRAGMENTS (POSSIBLE COPPER)- FROM BELOW DRIVER SEAT OF CHP UNIT #4455	RET	
BMD48		CUT PIECE OF AIRBAG WITH PROJECTILE FRAGMENTS (POSSIBLE COPPER/LEAD)- FROM STRIKE MARK "H1" TO DRIVER "A" PILLAR AIRBAG OF CHP UNIT #4455	RET	
BMD49		JACKETED PROJECTILE (POSSIBLE COPPER/LEAD) - FROM STRIKE MARK "EEE2" TO TRUNK CLOTH UNDER SPARE TIRE OF CHP UNIT #4455	RET	
BMD50		JACKETED PROJECTILE (POSSIBLE COPPER/LEAD) - FROM TRUNK SPARE TIRE WELL OF CHP UNIT #4455	RET	
BMD51		PROJECTILE FRAGMENT (POSSIBLE COPPER) - FROM STRIKE MARK "EEE2" TO TRUNK CLOTH UNDER SPARE TIRE OF CHP UNIT #4455	RET	
BMD52		JACKETED PROJECTILE AND FRAGMENT (POSSIBLE COPPER/LEAD) - FROM STRIKE MARK "YY" TO REAR PASSENGER SIDE TAIL LIGHT OF CHP UNIT #4455	RET	
BMD53		PROJECTILE FRAGMENTS (POSSIBLE COPPER) - FROM STRIKE MARK "BBBB" TO UNDERCARRIAGE UNIBODY REAR PASSENGER SIDE OF CHP UNIT #4455	RET	
BMD54		(3) JACKETED PROJECTILES AND FRAGMENTS (POSSIBLE COPPER/LEAD) - INTERIOR OF SPARE TIRE FOR CHP UNIT #4455	RET	
BMD55		PROJECTILE FRAGMENTS (POSSIBLE COPPER/LEAD) - INTERIOR OF DRIVER FRONT TIRE FOR CHP UNIT #4455	RET	
BMD56		JACKETED PROJECTILE AND FRAGMENTS (POSSIBLE COPPER/LEAD) - INTERIOR OF PASSENGER FRONT TIRE FOR CHP UNIT #4455	RET	
BMD57		JACKETED PROJECTILE AND FRAGMENTS (POSSIBLE COPPER/LEAD) - INTERIOR OF PASSENGER REAR TIRE FOR CHP UNIT #4455	RET	

* Last Item *

**Riverside Police Department
PROPERTY REPORT**

File No.
190023109

Date/Time
08/12/19 -05:38

Type of Complaint 187 - MURDER		Address Box Springs/ Eastridge Ave			
Victim [REDACTED]	DOB	Sex M	Race White	Address	
Arrestee / Suspect	DOB	Sex	Race	Address	
Arrestee / Suspect	DOB	Sex	Race	Address	
Arrestee / Suspect	DOB	Sex	Race	Address	
Finder [REDACTED]	DOB	Sex M	Race White	Address 10540 Magnolia Ave - Riversi	Phone No.
By Officer(s) [REDACTED]	ID No. [REDACTED]	Supvr. Approving	RMC/RSC Case No.		Property Clerk

Item	Owner	Itemize, Describe, List Serial Numbers... Only 1 Article per line	Prop. Loc.	Rel. Dispo
WEAP01		"REMINGTON" 12 GAUGE SHOTGUN, MODEL 870 POLICE MAGNUM, SERIAL #A588064M WITH (4) SHOTGUN SHELLS FROM MAGAZINE TUBE AND (5) SHOTGUN SHELLS FROM SIDE SADDLE MAGAZINE (POSSIBLE STRIKE MARKS TO PUMP AND STRAP)- REMOVED FROM GUN RACK OF CHP UNIT #4455 Gun Make: REM - Remington Arms Co., Inc. Weapon Type: S - SHOTGUN Weapon Category: P - PUMP ACTION Caliber: 12 GAUGE Model: 870 POLICE MAGNUM	RET	
WEAP02		"SIG SAUER" 5.56 NATO CALIBER RIFLE, MODEL SIG M400, SERIAL #2618CHP WITH (20) LIVE .223 CARTRIDGES FROM THE LOADED MAGAZINE AND (2) MAGAZINES WITH (40) 223 CALIBER CARTRIDGES FROM SIDE SADDLE HOLDER - REMOVED FROM GUN RACK OF CHP UNIT #4455 Gun Make: SSS - Sig-Sauer Weapon Type: R - RIFLE Weapon Category: I - SEMI-AUTO(autoloading) Caliber: 5.56 NATO Model: SIG M400	RET	

* Last Item *

**Riverside Police Department
PROPERTY REPORT**

File No.
190023109

Date/Time
08/12/19 -05:38

Type of Complaint 187 - MURDER		Address Box Springs/ Eastridge Ave			
Victim [REDACTED]	DOB	Sex M	Race White	Address	
Arrestee / Suspect	DOB	Sex	Race	Address	
Arrestee / Suspect	DOB	Sex	Race	Address	
Arrestee / Suspect	DOB	Sex	Race	Address	
Finder [REDACTED]	DOB	Sex M	Race White	Address 10540 Magnolia Ave - Riverside	Phone No.
By [REDACTED]	Supvr. Approving	RMC/RSC Case No.			Property Clerk

Item	Owner	Itemize, Describe, List Serial Numbers... Only 1 Article per line	Prop. Loc.	Rel. Dispo
KES01		(1) Beige "Frontline Call of Duty" L/S CHP uniform shirt, size 15/33; (1) Pair of beige "Flying Cross" CHP uniform pants	N2B	
SMI01		(1) Pair of beige "United Uniform" CHP pants; (2) black gloves from rear left pocket of pants	N2B	
SMI02		SMITH & WESSON .40 CAL SEMI-AUTO PISTOL MODEL M&P 40 BBL 4 SN: JBV8354 COL BLACK - CHP OFC SMITH S/N: JBV8354 / Gun Make: SW - Smith & Wesson Weapon Type: P - PISTOL Weapon Category: I - SEMI-AUTO(autoloading) Caliber: .40 Model: M&P 40	OUT2DOJ	
SMI02A		(1) Black magazine from firearm; (15) "Federal S&W 40" cartridges	OUT2DOJ	
SMI02B		(2) Black magazines from CHP Officer R. Smith's duty belt; (7) "Federal S&W 40" cartridges; (5) "Federal S&W 40" cartridges	OUT2DOJ	
SMI02C		(1) "Federal S&W 40" cartridge from firearm chamber	OUT2DOJ	

* Last Item *

**Riverside Police Department
PROPERTY REPORT**

File No.
190023109

Date/Time
08/12/19 -05:38

Type of Complaint 187 - MURDER		Address Box Springs/ Eastridge Ave			
Victim [REDACTED]	DOB	Sex M	Race White	Address	
Arrestee / Suspect	DOB	Sex	Race	Address	
Arrestee / Suspect	DOB	Sex	Race	Address	
Arrestee / Suspect	DOB	Sex	Race	Address	
Finder [REDACTED]	DOB	Sex M	Race White	Address 10540 Magnolia Ave - Riverside	Phone No.
By [REDACTED]	Supvr. Approving	RMC/RSC Case No.			Property Clerk

Item	Owner	Itemize, Describe, List Serial Numbers... Only 1 Article per line	Prop. Loc.	Rel. Dispo
BMD01		PROJECTILE FRAGMENT (POSSIBLE COPPER)- FROM STRAP OF ITEM #WEAP01 REMOVED FROM CHP UNIT #4455	RET	
BMD02		JACKETED PROJECTILE AND FRAGMENT (POSSIBLE COPPER/LEAD)- FROM EXTERIOR REAR BUMPER, PASSENGER SIDE OF CHP UNIT #4455	RET	
BMD03		JACKETED PROJECTILE (POSSIBLE COPPER/LEAD)- FROM TRUNK ON TOP OF "STINGER" SPIKE STRIP BOX OF CHP UNIT #4455	RET	
BMD04		JACKETED PROJECTILE (POSSIBLE COPPER/LEAD) - FROM TRUNK MIDDLE PULL-OUT TRAY OF CHP UNIT #4455	RET	
BMD05		PROJECTILE FRAGMENT (POSSIBLE COPPER)- FROM FRONT DRIVERSIDE FENDER WELL OF CHP UNIT #4455	RET	
BMD06		PROJECTILE FRAGMENTS (POSSIBLE LEAD)- FROM STRIKE MARK "L" ON FRONT DRIVERSIDE EXTERIOR BUMPER OF CHP UNIT #4455	RET	
BMD07		PROJECTILE FRAGMENTS (POSSIBLE COPPER/LEAD)- FROM REAR DRIVER SIDE DOOR ARM REST OF CHP UNIT #4455	RET	
BMD08		PROJECTILE FRAGMENTS (POSSIBLE COPPER/LEAD)- FROM REAR MIDDLE SEAT OF CHP UNIT #4455	RET	
BMD09		PROJECTILE FRAGMENT (POSSIBLE COPPER)- FROM STRIKE MARK "I-XX" TO TRUNK TOP WOOD TRAY OF CHP UNIT #4455	RET	
BMD10		PROJECTILE FRAGMENT (POSSIBLE LEAD)- FROM FRONT PASSENGER SEAT BACK OF CHP UNIT #4455	RET	
BMD11		PROJECTILE FRAGMENT (POSSIBLE LEAD)- FROM UNDERNEATH FRONT PASSENGER SEAT OF CHP UNIT #4455	RET	
BMD12		PROJECTILE FRAGMENT (POSSIBLE LEAD)- FROM DRIVER SIDE OF TRUNK AREA HEADLINER OF CHP UNIT #4455	RET	
BMD13		PROJECTILE FRAGMENTS (POSSIBLE COPPER)- FROM TRUNK FLOOR (SPARE TIRE COVER) OF CHP UNIT #4455	RET	
BMD14		JACKETED PROJECTILE (POSSIBLE COPPER/LEAD)- FROM TRUNK 3RD/BOTTOM PULL-OUT TRAY OF CHP UNIT #4455	RET	
BMD15		PROJECTILE FRAGMENT (POSSIBLE COPPER)- FROM UNDERCARRIAGE COVER FOR EVAP CANNISTER OF CHP UNIT #4455	RET	
BMD16		PROJECTILE FRAGMENTS (POSSIBLE LEAD)- FROM INTERIOR SIDE OF REAR PASSENGER RIM/WHEEL OF CHP UNIT #4455	RET	
BMD17		PROJECTILE FRAGMENT (POSSIBLE COPPER)- FROM DRIVER FRONT FENDER WELL OF CHP UNIT #4455	RET	
BMD18		PROJECTILE FRAGMENT (POSSIBLE COPPER)- FROM STRIKE MARK "JJJJ" TO UNDERCARRIAGE PASSENGER SIDE FUEL TANK OF CHP UNIT #4455	RET	

**Riverside Police Department
PROPERTY REPORT**

File No.
190023109

Date/Time
08/12/19 -05:38

Type of Complaint 187 - MURDER		Address Box Springs/ Eastridge Ave			
Arrestee / Suspect	DOB	Sex	Race	Address	
Arrestee / Suspect	DOB	Sex	Race	Address	
Finder	DOB	Sex M	Race White	Address 10540 Magnolia Ave - Riversi	Phone No.

Item	Owner	Itemize, Describe, List Serial Numbers... Only 1 Article per line	Prop. Loc.	Rel. Dispo
BMD19		PROJECTILE FRAGMENT (POSSIBLE LEAD)- FROM DRIVER SIDE UNDERCARRIAGE EXHAUST PIPE OF CHP UNIT #4455	RET	
BMD20		JACKETED PROJECTILE AND FRAGMENTS (POSSIBLE COPPER/LEAD)- FROM PASSENGER SIDE EXHAUST PIPE OF CHP UNIT #4455	RET	
BMD21		PROJECTILE FRAGMENTS (POSSIBLE COPPER)- FROM STRIKE MARK "CCCC" TO UNDERCARRIAGE PASSENGER SIDE REAR UNIBODY OF CHP UNIT #4455	RET	
BMD22		PROJECTILE FRAGMENTS (POSSIBLE COPPER)- FROM STRIKE MARK "DDDD" TO UNDERCARRIAGE PASSENGER SIDE REAR UNIBODY OF CHP UNIT #4455	RET	
BMD23		POSSIBLE PROJECTILE FRAGMENT- FROM LOWER FRONT BUMPER BEHIND GRILL OF CHP UNIT #4455	RET	
BMD24		PROJECTILE FRAGMENT (POSSIBLE COPPER)- FROM STRIKE MARK "Q3" TO LOWER FRONT WINDSHIELD COWL PANEL OF CHP UNIT #4455	RET	
BMD25		PROJECTILE FRAGMENT (POSSIBLE LEAD)- FROM STRIKE MARK "Q2" TO STRUT TOWER BRACE OF CHP UNIT #4455	RET	
BMD26		PROJECTILE FRAGMENTS (POSSIBLE COPPER)- FROM STRIKE MARK "K4" TO DRIVERSIDE UPPER COWL PANEL OF CHP UNIT #4455	RET	
BMD27		JACKETED PROJECTILE AND FRAGMENT (POSSIBLE COPPER/LEAD)- FROM STRIKE MARK "Y" TO ROOF LIGHT BAR OF CHP UNIT #4455	RET	
BMD28		PROJECTILE FRAGMENT (POSSIBLE COPPER)- FROM STRIKE MARK "T" TO ROOF LIGHT BAR OF CHP UNIT #4455	RET	
BMD29		PROJECTILE FRAGMENT (POSSIBLE COPPER)- FROM BEHIND FRONT PASSENGER SEAT OF CHP UNIT #4455	RET	
BMD30		POSSIBLE PROJECTILE FRAGMENTS (POSSIBLE LEAD)- FROM FRONT PASSENGER ROOF HEADLINER OF CHP UNIT #4455	RET	
BMD31		PROJECTILE FRAGMENT (POSSIBLE COPPER)- FROM STRIKE MARK "I-MM" TO FRONT CABIN SIDE OF FOAM ROLL BAR OF CHP UNIT #4455	RET	
BMD32		PROJECTILE FRAGMENT (POSSIBLE LEAD)- FROM STRIKE MARK "I-YY 1" TO INTERIOR (ROOF SIDE) OF HEADLINER ABOVE GATE OF CHP UNIT #4455	RET	
BMD33		PROJECTILE FRAGMENTS (POSSIBLE COPPER)- FROM INTERIOR (ROOF SIDE) OF HEADLINER FRONT PASSENGER SIDE OF CHP UNIT #4455	RET	
BMD34		PROJECTILE FRAGMENT (POSSIBLE COPPER)- FROM STRIKE MARK "I-II" TO REAR PASSENGER SIDE ROOF HEADLINER OF CHP UNIT #4455	RET	
BMD35		PROJECTILE FRAGMENT (POSSIBLE COPPER)- FROM STRIKE MARK "I-NN" TO DRIVER SIDE OF CAGE FRAME OF CHP UNIT #4455	RET	
BMD36		PROJECTILE FRAGMENT (POSSIBLE COPPER)- FROM STRIKE MARK "I-K" TO FRONT PASSENGER SIDE OF FOAM ROLL BAR OF CHP UNIT #4455	RET	
BMD37		PROJECTILE FRAGMENT (POSSIBLE LEAD)- FROM STRIKE MARK "I-W" TO REAR DRIVER SIDE PASSENGER SEAT BACK OF CHP UNIT #4455	RET	
BMD38		PROJECTILE FRAGMENT (POSSIBLE LEAD)- FROM STRIKE MARK "I-LL" TO ROOF HEADLINER ABOVE FRONT PASSENGER SEAT OF CHP UNIT #4455	RET	
BMD39		PROJECTILE FRAGMENT (POSSIBLE LEAD)- FROM REAR DRIVER SIDE INTERIOR LOWER BUMPER COVER AREA OF CHP UNIT #4455	RET	

**Riverside Police Department
PROPERTY REPORT**

File No.
190023109

Date/Time
08/12/19 -05:38

Type of Complaint 187 - MURDER		Address Box Springs/ Eastridge Ave			
Arrestee / Suspect	DOB	Sex	Race	Address	
Arrestee / Suspect	DOB	Sex	Race	Address	
Finder	DOB	Sex M	Race White	Address 10540 Magnolia Ave - Riverside	Phone No.

Item	Owner	Itemize, Describe, List Serial Numbers... Only 1 Article per line	Prop. Loc.	Rel. Dispo
BMD40		JACKETED PROJECTILE AND FRAGMENTS (POSSIBLE COPPER/LEAD)- FROM REAR DRIVER SIDE INTERIOR LOWER BUMPER COVER BEHIND VENT OF CHP UNIT #4455	RET	
BMD41		JACKETED PROJECTILE (POSSIBLE COPPER/LEAD)- FROM STRIKE MARK "I-EEE" TO INTERIOR OF REAR DRIVER SIDE SEAT BACK OF CHP UNIT #4455	RET	
BMD42		JACKETED PROJECTILE (POSSIBLE COPPER/LEAD)- FROM STRIKE MARK "LL" TO REAR DRIVER SIDE TAIL LIGHT OF CHP UNIT #4455	RET	
BMD43		PROJECTILE FRAGMENTS (POSSIBLE COPPER)- FROM TRUNK WOODEN TOP TRAY OF CHP UNIT #4455	RET	
BMD44		PROJECTILE FRAGMENT (POSSIBLE COPPER)- FROM STRIKE MARK "I-GGG" TO YELLOW EMERGENCY BLANKET PACKAGE FROM TRUNK TOP WOODEN TRAY OF CHP UNIT #4455	RET	
BMD45		PROJECTILE FRAGMENTS (POSSIBLE COPPER)- FROM BEHIND REAR PASSENGER SEAT OF CHP UNIT #4455	RET	
BMD46		PROJECTILE FRAGMENT (POSSIBLE LEAD)- FROM CREVICE BETWEEN REAR GRILL/GATE AND TRUNK RACKS OF CHP UNIT #4455	RET	
BMD47		PROJECTILE FRAGMENTS (POSSIBLE COPPER)- FROM BELOW DRIVER SEAT OF CHP UNIT #4455	RET	
BMD48		CUT PIECE OF AIRBAG WITH PROJECTILE FRAGMENTS (POSSIBLE COPPER/LEAD)- FROM STRIKE MARK "H1" TO DRIVER "A" PILLAR AIRBAG OF CHP UNIT #4455	RET	
BMD49		JACKETED PROJECTILE (POSSIBLE COPPER/LEAD) - FROM STRIKE MARK "EEE2" TO TRUNK CLOTH UNDER SPARE TIRE OF CHP UNIT #4455	RET	
BMD50		JACKETED PROJECTILE (POSSIBLE COPPER/LEAD) - FROM TRUNK SPARE TIRE WELL OF CHP UNIT #4455	RET	
BMD51		PROJECTILE FRAGMENT (POSSIBLE COPPER) - FROM STRIKE MARK "EEE2" TO TRUNK CLOTH UNDER SPARE TIRE OF CHP UNIT #4455	RET	
BMD52		JACKETED PROJECTILE AND FRAGMENT (POSSIBLE COPPER/LEAD) - FROM STRIKE MARK "YY" TO REAR PASSENGER SIDE TAIL LIGHT OF CHP UNIT #4455	RET	
BMD53		PROJECTILE FRAGMENTS (POSSIBLE COPPER) - FROM STRIKE MARK "BBBB" TO UNDERCARRIAGE UNIBODY REAR PASSENGER SIDE OF CHP UNIT #4455	RET	
BMD54		(3) JACKETED PROJECTILES AND FRAGMENTS (POSSIBLE COPPER/LEAD) - INTERIOR OF SPARE TIRE FOR CHP UNIT #4455	RET	
BMD55		PROJECTILE FRAGMENTS (POSSIBLE COPPER/LEAD) - INTERIOR OF DRIVER FRONT TIRE FOR CHP UNIT #4455	RET	
BMD56		JACKETED PROJECTILE AND FRAGMENTS (POSSIBLE COPPER/LEAD) - INTERIOR OF PASSENGER FRONT TIRE FOR CHP UNIT #4455	RET	
BMD57		JACKETED PROJECTILE AND FRAGMENTS (POSSIBLE COPPER/LEAD) - INTERIOR OF PASSENGER REAR TIRE FOR CHP UNIT #4455	RET	

* Last Item *

**Riverside Police Department
PROPERTY REPORT**

File No.
190023109

Date/Time
08/12/19 -05:38

Type of Complaint 187 - MURDER		Address Box Springs/ Eastridge Ave			
Victim [REDACTED]	DOB	Sex M	Race White	Address	
Arrestee / Suspect	DOB	Sex	Race	Address	
Arrestee / Suspect	DOB	Sex	Race	Address	
Arrestee / Suspect	DOB	Sex	Race	Address	
Finder [REDACTED]	DOB	Sex M	Race White	Address 10540 Magnolia Ave - Riverside	Phone No.
By Officer(s) [REDACTED]	ID No. [REDACTED]	Supvr. Approving	RMC/RSC Case No.		Property Clerk

Item	Owner	Itemize, Describe, List Serial Numbers... Only 1 Article per line	Prop. Loc.	Rel. Dispo
WEAP01		"REMINGTON" 12 GAUGE SHOTGUN, MODEL 870 POLICE MAGNUM, SERIAL #A588064M WITH (4) SHOTGUN SHELLS FROM MAGAZINE TUBE AND (5) SHOTGUN SHELLS FROM SIDE SADDLE MAGAZINE (POSSIBLE STRIKE MARKS TO PUMP AND STRAP)- REMOVED FROM GUN RACK OF CHP UNIT #4455 Gun Make: REM - Remington Arms Co., Inc. Weapon Type: S - SHOTGUN Weapon Category: P - PUMP ACTION Caliber: 12 GAUGE Model: 870 POLICE MAGNUM	RET	
WEAP02		"SIG SAUER" 5.56 NATO CALIBER RIFLE, MODEL SIG M400, SERIAL #2618CHP WITH (20) LIVE .223 CARTRIDGES FROM THE LOADED MAGAZINE AND (2) MAGAZINES WITH (40) 223 CALIBER CARTRIDGES FROM SIDE SADDLE HOLDER - REMOVED FROM GUN RACK OF CHP UNIT #4455 Gun Make: SSS - Sig-Sauer Weapon Type: R - RIFLE Weapon Category: I - SEMI-AUTO(autoloading) Caliber: 5.56 NATO Model: SIG M400	RET	

* Last Item *

**Riverside Police Department
PROPERTY REPORT**

File No.
190023109

Date/Time
08/12/19 -05:38

Type of Complaint 187 - MURDER		Address Box Springs/ Eastridge Ave			
Victim	DOB	Sex	Race	Address	
Arrestee / Suspect	DOB	Sex	Race	Address	
Arrestee / Suspect	DOB	Sex	Race	Address	
Arrestee / Suspect	DOB	Sex	Race	Address	
Finder	DOB	Sex M	Race White	Address 10540 Magnolia Ave - Riversi	Phone No.
Officer(s)	ID No.	Supvr. Approving	RMC/RSC Case No.		Property Clerk

Item	Owner	Itemize, Describe, List Serial Numbers... Only 1 Article per line	Prop. Loc.	Rel. Dispo
BE01		(1) CONTROL & (1) SAMPLE SWAB OF POSSIBLE BLOOD- FROM RIGHT RING FINGER OF RSO DEPUTY [REDACTED]	RET	
BE02		(1) CONTROL & (1) SAMPLE SWAB OF POSSIBLE BLOOD- FROM LEFT UNIFORM SHIRT POCKET OF RSO [REDACTED]	RET	
BE03		(1) CONTROL & (1) SAMPLE SWAB OF POSSIBLE BLOOD- FROM RIGHT BOOT TOE LEATHER UPPER OF [REDACTED]	RET	
BE04		"GLOCK" 9MM SEMI-AUTO PISTOL, MODEL 17, SERIAL #WSM804, ATTACHED TLR-1 HL "STREAMLIGHT"- FROM RSO DEPUTY [REDACTED] Gun Make: GLC - Glock, Inc. Weapon Type: P - PISTOL Weapon Category: I - SEMI-AUTO(autoloading) Caliber: 9MM Model: 17	RET	
BE04-A		(1) "WIN 9MM LUGER" CARTRIDGE (LIVE) - REMOVED FROM CHAMBER OF ITEM #BE04	RET	
BE04-B		PISTOL MAGAZINE AND (15) "WIN 9MM LUGER" CARTRIDGES (LIVE) WITH POSSIBLE BLOOD- REMOVED FROM ITEM #BE04	RET	
DG01		"GLOCK" .40 CALIBER SEMI-AUTO PISTOL, MODEL 22 GEN 4, SERIAL #UKG789- FROM RSO [REDACTED] Gun Make: GLC - Glock, Inc. Weapon Type: P - PISTOL Weapon Category: I - SEMI-AUTO(autoloading) Caliber: .40 Model: 22 GEN 4	RET	
DG01-A		(1) "FEDERAL 40 S&W" CARTRIDGE (LIVE)- REMOVED FROM CHAMBER OF ITEM #DG01	RET	
DG01-B		PISTOL MAGAZINE AND (14) "FEDERAL 40 S&W" CARTRIDGES (LIVE)- REMOVED FROM ITEM #DG01	RET	
JV01		(1) CONTROL & (1) SAMPLE SWAB OF POSSIBLE BLOOD- FROM RIGHT FOREARM OF RSO DEPUTY [REDACTED]	RET	
JV02		(2) BUCCAL DNA EXEMPLAR SWABS- FROM MOUTH OF RSO DEPUTY [REDACTED]	RET	
KF01		"COLT" 5.56 MM RIFLE, MODEL LAW ENFORCEMENT, SERIAL #LE066024 WITH STRAP, ATTACHED TLR-1 HL "STREAMLIGHT", AND ATTACHED SCOPE (FIREARM FOR RPD OFFICER KEVIN FEIMER)- REMOVED FROM TRUNK OF RPD UNIT #3849 Gun Make: CLT - Colt Weapon Type: R - RIFLE Weapon Category: C - CARBINE Caliber: 5.56 MM Model: LAW ENFORCEMENT	RET	
KF01-A		"WMA 16" 5.56 MM CARTRIDGE (LIVE)- REMOVED FROM CHAMBER OF ITEM #KF01	RET	
KF01-B		RIFLE MAGAZINE AND (16) "WMA 16" 5.56 MM CARTRIDGES (LIVE)- REMOVED FROM ITEM #KF01	RET	

**Riverside Police Department
PROPERTY REPORT**

File No.
190023109

Date/Time
08/12/19 -05:38

Type of Complaint 187 - MURDER		Address Box Springs/ Eastridge Ave			
Arrestee / Suspect	DOB	Sex	Race	Address	
Arrestee / Suspect	DOB	Sex	Race	Address	
Finder	DOB	Sex M	Race White	Address 10540 Magnolia Ave - Riverside	Phone No.

Item	Owner	Itemize, Describe, List Serial Numbers... Only 1 Article per line	Prop. Loc.	Rel. Dispo
MCHAP01		(1) CONTROL & (1) SAMPLE SWAB OF POSSIBLE BLOOD- FROM RIGHT PALM OF RSO DEPUTY [REDACTED]	RET	
MCHAP02		(1) CONTROL & (1) SAMPLE SWAB OF POSSIBLE BLOOD- FROM LEFT PALM OF RSO DEPUTY [REDACTED]	RET	
MCHAP03		(2) BUCCAL DNA EXEMPLAR SWABS- FROM MOUTH OF RSO [REDACTED]	RET	
MCHAV01		"SPRINGFIELD" 9MM SEMI-AUTO PISTOL, MODEL XD-9 MOD. 2, SERIAL #GM826702 WITH ATTACHED TLR-1 HL "STREAMLIGHT"- FROM RSO DEPUTY [REDACTED] Gun Make: SPH1 - Springfield Armory (Springfield, IL) Weapon Type: P - PISTOL Weapon Category: I - SEMI-AUTO(autoloading) Caliber: 9MM Model: XD-9	RET	
MCHAV01-A		(1) "WIN 9MM LUGER" CARTRIDGE (LIVE)- REMOVED FROM CHAMBER OF ITEM #MCHAV01	RET	
MCHAV01-B		PISTOL MAGAZINE AND (16) "WIN 9MM LUGER" CARTRIDGES (LIVE)- REMOVED FROM ITEM #MCHAV01	RET	
OV58		"SMITH & WESSON" .40 CALIBER SEMI-AUTO PISTOL, MODEL M&P, SERIAL #JBC8786 (POSSIBLE BLOOD & DIRT)- FROM STREET Gun Make: SW - Smith & Wesson Weapon Type: P - PISTOL Weapon Category: I - SEMI-AUTO(autoloading) Caliber: .40 Model: M&P	RET	
OV58-A		PISTOL MAGAZINE (EMPTY) WITH POSSIBLE BLOOD- REMOVED FROM ITEM #OV58	RET	
VM01		"SIG SAUER" 5.56 NATO RIFLE, MODEL SIG M400, SERIAL #2695CHP WITH STRAP (FIREARM FOR CHP OFFICER [REDACTED]) - REMOVED FROM REAR SEAT OF RSO UNIT #18-003 Gun Make: SSS - Sig-Sauer Weapon Type: R - RIFLE Caliber: 5.56 NATO Model: SIG M400	RET	
VM01-A		RIFLE MAGAZINE WITH (3) "SPEER 17 223 REM" CARTRIDGES (LIVE)- REMOVED FROM REAR SEAT OF RSO UNIT #18-003	RET	
VM01-B		RIFLE MAGAZINE WITH (20) "SPEER 17 223 REM" CARTRIDGES (LIVE)- REMOVED FROM REAR SADDLE MAGAZINE HOLDER (OPPOSITE EJECTOR PORT)	RET	
VM01-C		RIFLE MAGAZINE WITH (20) "SPEER 17 223 REM" CARTRIDGES (LIVE)- REMOVED FROM REAR SADDLE MAGAZINE HOLDER (EJECTOR PORT SIDE)	RET	
WS-1		(1) SAMPLE SWAB OF STERILE COLLECTION WATER- FOR MORENO VALLEY PD SAMPLES BEFORE 2251 HOURS	RET	
WS-2		(1) SAMPLE SWAB OF STERILE COLLECTION WATER- FOR MORENO VALLEY PD SAMPLES ON AFTER 8/12/19 AT 2252 HOURS	RET	

* Last Item *

**Riverside Police Department
PROPERTY REPORT**

File No.
190023109

Date/Time
08/12/19 -05:38

Type of Complaint 187 - MURDER		Address Box Springs/ Eastridge Ave			
Victim	DOB	Sex	Race	Address	
Arrestee / Suspect	DOB	Sex	Race	Address	
Arrestee / Suspect	DOB	Sex	Race	Address	
Arrestee / Suspect	DOB	Sex	Race	Address	
Finder Quinn, 1535	DOB	Sex M	Race White	Address 10540 Magnolia Ave - Riversi	Phone No.
By Of	Supvr. Approving	RMC/RSC Case No.		Property Clerk	

Item	Owner	Itemize, Describe, List Serial Numbers... Only 1 Article per line	Prop. Loc	Rel. Dispo
LUTH04		(2) Buccal samples from suspect LUTHER, AARON.	RET	
LUTH05		Wallet, received from hospital staff, suspect LUTHER, AARON.	RET	
LUTH06		Handcuffs removed from wrists of suspect LUTHER, AARON, received from Deputy Coroner [REDACTED]	RET	
LUTH07		GSR kit from hands of suspect LUTHER, AARON, received from Deputy Coroner [REDACTED]	RET	
LUTH08		Possible DNA swabs from palm and backside of right hand, suspect LUTHER, AARON.	RET	
LUTH09		Possible DNA swabs from palm and backside of left hand, suspect LUTHER, AARON.	RET	
LUTH10		Black shirt (Hanes 2XL), removed from under suspect LUTHER, AARON.	RET	
LUTH11		Boxer briefs, blue and black stripe, Fruit of the Loom, removed from suspect LUTHER, AARON.	RET	
MOY005		American flag, removed from victim MOYE, ANDRE.	RET	
MOY006		Hospital blankets, removed from victim MOYE, ANDRE.	RET	
MOY007		GSR kit from hands of victim MOYE, ANDRE, received from Deputy Coroner [REDACTED]	RET	
MOY008		Possible DNA sample swabs from the palm and backside of right hand, victim MOYE, ANDRE.	RET	
MOY009		Possible DNA sample swabs from the palm and backside of left hand, victim MOYE, ANDRE.	RET	
MOY010		Nail clippings from the hands of victim MOYE, ANDRE, received from Deputy Coroner [REDACTED]	RET	
MOY011		(2) Buccal samples from victim MOYE, ANDRE.	RET	
MOY012		Motorcycle helmet (CHP) with HT, victim MOYE, ANDRE, received from hospital staff.	RET	
MOY013		Duty Belt with set of keys and handcuffs, removed from under victim MOYE, ANDRE.	RET	
MOY014		Uniform pants, removed from under victim MOYE, ANDRE.	RET	
MOY015		Notebook/cite pads, removed from right, front uniform pocket (MOY0018), victim MOYE, ANDRE.	RET	
MOY016		Flashlight, black, victim MOYE, ANDRE, received from hospital staff.	RET	
MOY017		Duty vest, victim MOYE, ANDRE, received from hospital staff.	RET	
MOY018		Uniform shirt, removed from under victim MOYE, ANDRE.	RET	
MOY019		White under-shirt, removed from under victim MOYE, ANDRE.	RET	
MOY020		(2) Motor uniform boots, victim MOYE, ANDRE, received from hospital staff.	RET	
MOY021		Folding knife, removed from right boot (MOY020), victim MOYE, ANDRE.	RET	
MOY022		(2) black socks, victim MOYE, ANDRE, received from hospital staff.	RET	

**Riverside Police Department
PROPERTY REPORT**

File No.
190023109

Date/Time
08/12/19 -05:38

Type of Complaint 187 - MURDER		Address Box Springs/ Eastridge Ave			
Arrestee / Suspect	DOB	Sex	Race	Address	
Arrestee / Suspect	DOB	Sex	Race	Address	
Finder	DOB	Sex M	Race White	Address 10540 Magnolia Ave - Riversi	Phone No.

Item	Owner	Itemize, Describe, List Serial Numbers... Only 1 Article per line	Prop. Loc.	Rel. Dispo
MOY023		Black boxer briefs and shirt keeper, victim MOYE, ANDRE, received from hospital staff.	RET	
MOY024		Smith & Wesson M&P 40, serial HYY5191, received from CHP [REDACTED] (victim MOYE, ANDRE). Gun Make: SW - Smith & Wesson Weapon Type: P - PISTOL Weapon Category: I - SEMI-AUTO(autoloading) Caliber: 40 cal Model: M&P 40	RET	
MOY025		40 cal Magazine, (loaded/15 rounds) and (1) 40 caliber round from chamber (MOY024).	RET	
MOY026		(2) 40 cal Magazine, (each loaded/15 rounds) from duty belt (MOY013).	RET	
MOY027		(2) eye drops, lip balm, and Jr. badge stickers removed from uniform shirt pockets (MOY018).	RET	
[REDACTED]01		Uniform pants with velcrow belt, received from hospital staff, victim [REDACTED]	RET	
[REDACTED]02		Folding knife, removed from rear pant pocket ([REDACTED]01).	RET	
[REDACTED]03		(2) Black gloves, removed from rear pant pocket ([REDACTED]01).	RET	
[REDACTED]04		Duty vest, received from hospital staff, victim [REDACTED]	RET	
[REDACTED]05		Uniform shirt, received from hospital staff, victim [REDACTED]	RET	
[REDACTED]06		White undershirt, received from hospital staff, victim [REDACTED]	RET	
[REDACTED]07		(2) Black duty boots, received from hospital staff, victim [REDACTED]	RET	
[REDACTED]08		(4) latex gloves, removed from left pant pocket ([REDACTED]01), victim [REDACTED]	RET	
[REDACTED]09		CHP Badge, name plate, and flag pin, removed from uniform shirt ([REDACTED]05), victim [REDACTED]	RET	
[REDACTED]10		(2) shirt keepers, (2) keys, notebook, and pencil removed from uniform shirt ([REDACTED]05), victim [REDACTED]	RET	
[REDACTED]11		Duty belt, with taser, and HT, received from CHP Officer [REDACTED] victim [REDACTED]	RET	
[REDACTED]12		Watch, received from CHP Officer [REDACTED] victim [REDACTED]	RET	
[REDACTED]13		(2) black socks, received from hospital staff, victim [REDACTED]	RET	
REAG01		Sterile water sample (used for collection).	RET	

* Last Item *

**Riverside Police Department
PROPERTY REPORT**

File No.
190023109

Date/Time
08/12/19 -05:38

Type of Complaint 187 - MURDER		Address Box Springs/ Eastridge Ave			
Victim [REDACTED]	DOB	Sex M	Race White	Address	
Arrestee / Suspect	DOB	Sex	Race	Address	
Arrestee / Suspect	DOB	Sex	Race	Address	
Arrestee / Suspect	DOB	Sex	Race	Address	
Finder [REDACTED]	DOB	Sex M	Race White	Address 10540 Magnolia Ave - Riverside	Phone No.
By Officer(s) [REDACTED]	ID No. [REDACTED]	Supvr. Approving	RMC/RSC Case No.		Property Clerk

Item	Owner	Itemize, Describe, List Serial Numbers... Only 1 Article per line	Prop. Loc.	Rel. Dispo
BM01		POSSIBLE PROJECTILE (POSSIBLE LEAD)- FROM PARKING LOT NORTH OF VISION HEATING AND AIR CONDITIONING GATED REAR LOT	RET	
BM02		JACKETED PROJECTILE (POSSIBLE COPPER AND LEAD)- FROM PARKING LOT NORTH OF VISION HEATING AND AIR CONDITIONING GATED REAR LOT	RET	
BM03		JACKETED PROJECTILE (POSSIBLE COPPER AND LEAD)- FROM PARKING LOT NORTH OF VISION HEATING AND AIR CONDITIONING GATED REAR LOT	RET	
BM04		SCRAPING OF POSSIBLE PROJECTILE STRIKE MARK "BM-A4"- FROM EAST SIDE OF VISION HEATING AND AIR CONDITIONING BUILDING	RET	
HELI01		(1) CONTROL & (1) SAMPLE SWAB OF POSSIBLE BLOOD- FROM REAR PILOT SIDE FLOOR BOARD OF RPD HELICOPTER UNIT #N911RP	RET	
HELI02		(1) CONTROL & (1) SAMPLE SWAB OF POSSIBLE BLOOD- FROM REAR PILOT SIDE OF CABIN DIVIDER WALL OF RPD HELICOPTER UNIT #N911RP	RET	
HELI03		(1) CONTROL & (1) SAMPLE SWAB OF POSSIBLE BLOOD- FROM HELMET IN PILOT SEAT OF RPD HELICOPTER UNIT #N911RP	RET	
HELI04		(1) CONTROL & (1) SAMPLE SWAB OF POSSIBLE BLOOD- FROM HELMET IN OBSERVER SEAT OF RPD HELICOPTER UNIT #N911RP	RET	
HELI-WS		(1) SAMPLE SWAB OF STERILE COLLECTION WATER- FOR RPD HELICOPTER UNIT #N911RP SAMPLES	RET	
OV47		"SMITH & WESSON" .40 CALIBER BLACK PISTOL MAGAZINE WITH (8) "FEDERAL 40 S&W" CARTRIDGES- FROM STREET	RET	
OV53		"SMITH & WESSON" .40 CALIBER BLACK PISTOL MAGAZINE WITH (3) "FEDERAL 40 S&W" CARTRIDGES- FROM STREET	RET	
OV57		"SMITH & WESSON".40 CALIBER BLACK PISTOL MAGAZINE (EMPTY)- FROM STREET	RET	
OV99		"SAVAGE" .22 LR CALIBER RIFLE, MODEL 64, SERIAL #2937401, AND DETACHED SCOPE INSIDE BLACK RIFLE BAG- FROM TRUNK OF KIA OPTIMA, CALIFORNIA LICENSE #7MYW037 Gun Make: SAV - Savage Arms Corp. Weapon Type: R - RIFLE Caliber: .22 LR Model: 64	RET	
OV99-A		BLACK RIFLE MAGAZINE- FROM RIFLE BAG OF ITEM #OV99	RET	
OV99-B		FIREARMS SAFETY CERTIFICATE FOR [REDACTED]- FROM RIFLE BAG OF ITEM #OV99	RET	

* Last Item *

**Riverside Police Department
PROPERTY REPORT**

File No. 190023109	Date/Time 08/12/19 -05:38
-----------------------	------------------------------

Type of Complaint 187 - MURDER		Address Box Springs/ Eastridge Ave			
Victim [REDACTED]	DOB	Sex M	Race White	Address	
Arrestee / Suspect	DOB	Sex	Race	Address	
Arrestee / Suspect	DOB	Sex	Race	Address	
Arrestee / Suspect	DOB	Sex	Race	Address	
Finder [REDACTED]	DOB	Sex M	Race White	Address 10540 Magnolia Ave - Riversi	Phone No.
By Officer(s) [REDACTED]	ID No. [REDACTED]	Supvr. Approving	RMC/RSC Case No.		Property Clerk

Item	Owner	Itemize, Describe, List Serial Numbers... Only 1 Article per line	Prop. Loc.	Rel. Dispo
EMBLEM01		METAL CHP HELMET EMBLEM (FROM OFFICER MOYE'S HELMET)- RECOVERED FROM DIRT HILL ON THE NORTHWEST SIDE OF EASTRIDGE AND 215 FREEWAY OVERPASS	RET	

* Last Item *

**Riverside Police Department
PROPERTY REPORT**

File No.
190023109

Date/Time
08/12/19 -05:38

Type of Complaint 187 - MURDER		Address Box Springs/ Eastridge Ave			
Victim [REDACTED]	DOB	Sex M	Race White	Address	
Arrestee / Suspect	DOB	Sex	Race	Address	
Arrestee / Suspect	DOB	Sex	Race	Address	
Arrestee / Suspect	DOB	Sex	Race	Address	
Finder Quinn, 1535	DOB	Sex M	Race White	Address 10540 Magnolia Ave - Riversi	Phone No.
By [REDACTED]	Supvr. Approving	RMC/RSC Case No.		Property Clerk	

Item	Owner	Itemize, Describe, List Serial Numbers... Only 1 Article per line	Prop. Loc.	Rel. Dispo
KIA01		(1) Control and (1) sample swab of possible blood from exterior front driver door frame	19187023	
KIA02		(1) Control and (1) sample swab of possible blood from exterior rear driver door (below handle)	19187023	
KIA03		(1) Control and (1) sample swab of possible blood from interior front driver door frame	19187023	
KIA04		(1) Control and (1) sample swab of possible blood from gear shift base frame (driver side)	19187023	
KIA05		Metal fragment from the rear driver floorboard (under floor mat)	19187023	
KIA06		(1) Sample swab of sterile collection water	19187023	

* Last Item *

**Riverside Police Department
PROPERTY REPORT**

File No.
190023109

Date/Time
08/12/19 -05:38

Type of Complaint 187 - MURDER		Address Box Springs/ Eastridge Ave			
Victim [REDACTED]	DOB	Sex M	Race White	Address	
Arrestee / Suspect	DOB	Sex	Race	Address	
Arrestee / Suspect	DOB	Sex	Race	Address	
Arrestee / Suspect	DOB	Sex	Race	Address	
Finder [REDACTED]	DOB	Sex M	Race White	Address 10540 Magnolia Ave - Riversi	Phone No.
[REDACTED]	Supvr. Approving	RMC/RSC Case No.			Property Clerk

Item	Owner	Itemize, Describe, List Serial Numbers... Only 1 Article per line	Prop. Loc.	Rel. Dispo
OV016A-A		(1) Control and (1) sample swab of possible blood from magazine (toward top on 5.56 caliber/model info side)	19187025	
OV016A-B		(1) Wet and (1) dry sample swab of possible DNA from entire magazines and electrical tape / Possible blood	19187025	
OV020A		(1) Wet and (1) dry sample swab of possible DNA from entire magazines and electrical tape	19187025	
REA02		(1) Sample swab of sterile collection water	19187025	

* Last Item *

**Riverside Police Department
PROPERTY REPORT**

File No.
190023109

Date/Time
08/12/19 -05:38

Type of Complaint 187 - MURDER		Address Box Springs/ Eastridge Ave			
Victim [REDACTED]	DOB	Sex M	Race White	Address	
Arrestee / Suspect	DOB	Sex	Race	Address	
Arrestee / Suspect	DOB	Sex	Race	Address	
Arrestee / Suspect	DOB	Sex	Race	Address	
Finder [REDACTED]	DOB	Sex M	Race White	Address 10540 Magnolia Ave - Riversi	Phone No.
[REDACTED]	Supvr. Approving	RMC/RSC Case No.		Property Clerk	

Item	Owner	Itemize, Describe, List Serial Numbers... Only 1 Article per line	Prop. Loc.	Rel. Dispo
TF-02		(2) 5.56 caliber cartridge cases test-fired from item OV016	MAG	

* Last Item *

**Riverside Police Department
PROPERTY REPORT**

File No. 190023109	Date/Time 08/12/19 -05:38
-----------------------	------------------------------

Type of Complaint 187 - MURDER		Address Box Springs/ Eastridge Ave			
Victim	DOB	Sex	Race	Address	
Arrestee / Suspect	DOB	Sex	Race	Address	
Arrestee / Suspect	DOB	Sex	Race	Address	
Arrestee / Suspect	DOB	Sex	Race	Address	
Finder	DOB	Sex M	Race White	Address 10540 Magnolia Ave - Riversi	Phone No.
[REDACTED]		Supvr. Approving	RMC/RSC Case No.		Property Clerk

Item	Owner	Itemize, Describe, List Serial Numbers... Only 1 Article per line	Prop. Loc.	Rel. Dispo
DMB001		(1) JACKETED PROJECTILE	MAG	

* Last Item *

**Riverside Police Department
PROPERTY REPORT**

File No.
190023109

Date/Time
08/12/19 -05:38

Type of Complaint 187 - MURDER		Address Box Springs/ Eastridge Ave			
Victim [REDACTED]	DOB	Sex M	Race White	Address	
Arrestee / Suspect	DOB	Sex	Race	Address	
Arrestee / Suspect	DOB	Sex	Race	Address	
Arrestee / Suspect	DOB	Sex	Race	Address	
Finder [REDACTED]	DOB	Sex M	Race White	Address 10540 Magnolia Ave - Riversi	Phone No.
By Officer(s) [REDACTED]	ID No.	Supvr. Approving	RMC/RSC Case No.		Property Clerk

Item	Owner	Itemize, Describe, List Serial Numbers... Only 1 Article per line	Prop. Loc.	Rel. Dispo
CES001		CD interview with [REDACTED]	RET	
CES002		CD interview with J [REDACTED]	RET	
CES003		CD with BWC video footage	RET	
CES004		CD containing VIEVU	RET	
CES005		CD with BWC from [REDACTED]	RET	
CES006		DVD w/photos fo [REDACTED]	RET	
CES007		DVD with interview with [REDACTED]	RET	
CES008		156 UAV photos of scene	RET	
CES009		Critical incident log, 3 pages	RET	
CES010		Dominion and control from suspects bedroom with suspect name	RET	
CES011		Dominion and control letter to suspect found on shelf above safe in water heater room	RET	
CES012		Three phones found in suspect bedroom. Two LG and One Samsung	RET	
CES013		Samsung cell phone found in suspect bedroom, unk model #	RET	
CES014		Four live .223 rounds. Three FC223 REM ONE TULAMMO 223 found in cup in suspect bedroom	RET	
CES015		Bag of live FC223REM rounds found in dining room area	RET	
CES016		Unk amount of possible methamphetamine found in small safe in garage	RET	
CES017		Thirty boxes of Amer Eagle .223 live rounds found in safe	RET	
CES018		Tactical rifle case found in suspect bedroom	RET	

* Last Item *

**Riverside Police Department
PROPERTY REPORT**

File No.
190023109

Date/Time
08/12/19 -05:38

Type of Complaint 187 - MURDER				Address Box Springs/ Eastridge Ave				
Victim	DOB	Sex	Race	Address				
Arrestee / Suspect	DOB	Sex	Race	Address				
Arrestee / Suspect	DOB	Sex	Race	Address				
Arrestee / Suspect	DOB	Sex	Race	Address				
Finder	DOB	Sex	Race	Address 10540 Magnolia Ave - Riverside		Phone No.		
By Officer(s)	ID No.	Supvr. Approving	RMC/RSC Case No.			Property Clerk		
Item	Owner	Itemize, Describe, List Serial Numbers... Only 1 Article per line					Prop. Loc.	Rel. Dispo
OV002		(1) "Speer 223 REM" cartridge from street					19187030	
OV003		(1) Metal projectile from street					19187030	
OV004		(1) Metal fragment from sidewalk					19187030	
OV005		(1) Metal jacketed projectile from street					19187030	
OV006		(1) Metal jacketed projectile from street					19187030	
OV007		(1) "WMA 16" cartridge case					19187030	
OV008		(1) Gray tow strap from street					N2A	
OV009		(1) "REM 223 FC" cartridge case from street					19187025	
OV010		(1) "REM 223 FC" cartridge case from street					19187025	
OV011		(1) Orange S/S "Russell" training fit t-shirt, size 2XL; Debris marks, holes					19187021	
OV012		(6) "REM 223 FC" cartridge cases from street					19187022	
OV013		(2) "REM 223 FC" cartridge cases from street					19187025	
OV014		(9) "REM 223 FC" cartridge cases from street					19187022	
OV015		(7) "REM 223 FC" cartridge cases					19187023	
OV016		UNKNOWN MAKE AND CALIBER SEMI-AUTO ASSAULT RIFLE, UNKNOWN MODEL AND SERIAL NUMBER, COLOR BLACK					DFIRECRT	
OV016A		(2) Empty black 5.56 caliber magazines taped together with black electrical tape / Possible blood					19187029	
OV017		(1) Gray tow strap					19187022	
OV018		(1) Pair of grey shorts w/ brown belt; (2) lighters and a charger; (2) brown/tan striped socks; (1) "Camel" cigarette box					N2A	
OV018A		(1) Pair of black/white "Puma" tennis shoes, size 11.5; Possible blood					19187021	
OV018B		Multiple keys from left front pocket of shorts					19187022	
OV019		(1) Orange "OccuNomix" L/S t-shirt with silver reflectors, size XL; Possible blood and holes					19187021	
OV020		(2) Empty black 5.56 caliber magazines taped together with black electrical tape					19187029	
OV021		(50) "REM 223 FC" cartridge cases					19187021	
OV022A		(1) Navy blue "King Sportswear" hooded L/S sweatshirt, size 2XL					N2A	
OV022B		(1) Blue/Silver "Tac-Force" knife, possible blood					N2B	

**Riverside Police Department
PROPERTY REPORT**

File No.
190023109

Date/Time
08/12/19 -05:38

Type of Complaint 187 - MURDER		Address Box Springs/ Eastridge Ave			
Arrestee / Suspect	DOB	Sex	Race	Address	
Arrestee / Suspect	DOB	Sex	Race	Address	
Finder	DOB	Sex M	Race White	Address 10540 Magnolia Ave - Riversi	Phone No.

Item	Owner	Itemize, Describe, List Serial Numbers... Only 1 Article per line	Prop. Loc.	Rel. Dispo
OV022B-A		(1) Original envelope that held OV022B	19187025	
OV022C		(1) Mult-colored backpack w/ misc. docs and tools; Possible blood	N2B	
OV022C-A		(1) Black 5.56 caliber magazine; (9) .223 cartridges from magazine	19187016	
OV022C-B		\$1.66 6 x .25 1 x .10 1 x .05 1 x .01 = \$1.66 Value: \$1.66	DEPOSITC	
OV023		(1) Control and (1) sample swab of possible blood from street	19187025	
OV024		(1) Silver "Coolpad" cell phone- Possible blood Color: SIL - SILVER OR ALUMINUM	O17287	
OV025		Misc clothes, personal items, tools (previously removed from GMC Truck)	NRP	
OV026		Multiple personal items and tools (previously removed from GMC Truck)	NRP	
OV027		(3) "REM 223 FC" cartridge cases	19187022	
OV028		(1) Metal jacketed projectile	19187025	
OV029		(1) Brown leather band with black face - cracked/broken, Apple Watch "Series 1"	19187025	
OV030		Sample of possible blood on brush (twigs) near sidewalk	19187022	
OV031		(1) Black pair of broken "Oakley" sunglasses; Possible blood	19187022	
OV032		(1) "REM 223 FC" cartridge case	19187025	
OV033A		(1) Black electronic device	19187025	
OV033B		(1) Yellow taser w/ labels "Moye" and "840-34"; serial #X30004135	19187029	
OV033C		(2) dark tan/black riding gloves	19187022	
OV034		(3) "REM 223 FC" cartridge cases	19187023	
OV035		(12) "REM 223 FC" cartridge cases from street	19187023	
OV036		(3) "REM 223 FC" cartridge cases	19187023	
OV037		(4) "REM 223 FC" cartridge cases	19187023	
OV038		(12) "REM 223 FC" cartridge cases	19187023	
OV039		(6) "REM 223 FC" cartridge cases	19187025	
OV040		(1) Metal jacket from street	19187025	
OV041		(4) "Federal 40 S&W" cartridge cases	19187025	
OV042		(1) Metal jacketed projectile	19187025	
OV043		(1) "Federal 40 S&W" cartridge case and metal fragment	19187025	
OV044		(1) Metal jacket fragment	19187025	
OV045		(1) Metal projectile	19187025	

**Riverside Police Department
PROPERTY REPORT**

File No.
190023109

Date/Time
08/12/19 -05:38

Type of Complaint 187 - MURDER		Address Box Springs/ Eastridge Ave			
Arrestee / Suspect	DOB	Sex	Race	Address	
Arrestee / Suspect	DOB	Sex	Race	Address	
Finder	DOB	Sex M	Race White	Address 10540 Magnolia Ave - Riverside	Phone No.

Item	Owner	Itemize, Describe, List Serial Numbers... Only 1 Article per line	Prop. Loc.	Rel. Dispo
OV046		(1) Metal projectile	19187025	
OV048		(4) "Federal 40 S&W" cartridge cases	19187030	
OV049		(3) "Federal 40 S&W" cartridge cases	19187025	
OV050		(1) Metal jacket fragment	19187025	
OV051		(5) "Federal 40 S&W" cartridge cases	19187025	
OV052		(1) "Federal 40 S&W" cartridge case	19187025	
OV054		(3) "Federal 40 S&W" cartridge cases	19187025	
OV055		(1) Control and (1) sample swab of possible blood from street	19187025	
OV056		(1) Black .40 S&W magazine (empty)	REL20TH	
OV059		(12) "Federal 40 S&W" cartridge cases	19187024	
OV060		(27) "Federal 40 S&W" cartridge cases	19187024	
OV061		(1) Metal jacketed fragment	19187025	
OV062		(2) "Federal 40 S&W" cartridge cases	19187024	
OV063		(1) Control and (1) sample swab of possible blood from street	19187025	
OV064		(8) "Federal 40 S&W" cartridge cases; (1) "FC 18 40 S&W" cartridge case	19187024	
OV065		(1) Control and (1) sample swab of possible blood from street	19187025	
OV066		(1) Metal jacket fragment	19187025	
OV067		(1) Metal projectile	19187025	
OV068		(1) Pair of black broken sunglasses	19187022	
OV069		(9) "Federal 40 S&W" cartridge cases	19187024	
OV070		(1) Metal jacket fragment from street	19187024	
OV071		(1) Metal projectile fragment from street	19187024	
OV072		(1) Metal jacket fragment	19187024	
OV073		(1) Pair of black/red "Ironman" sunglasses	19187024	
OV074		(6) "WIN 9mm Luger" cartridge cases	19187030	
OV075		(2) "WIN 9mm Luger" cartridge cases	19187024	
OV076		(1) "WIN 9mm Luger" cartridge case	19187024	
OV077		(1) "WIN 9mm Luger" cartridge case	19187024	
OV078		(2) "WIN 9mm Luger" cartridge cases	19187030	
OV079		(1) Metal jacket fragment	19187030	

**Riverside Police Department
PROPERTY REPORT**

File No.
190023109

Date/Time
08/12/19 -05:38

Type of Complaint 187 - MURDER		Address Box Springs/ Eastridge Ave			
Arrestee / Suspect	DOB	Sex	Race	Address	
Arrestee / Suspect	DOB	Sex	Race	Address	
Finder	DOB	Sex M	Race White	Address 10540 Magnolia Ave - Riversi	Phone No.

Item	Owner	Itemize, Describe, List Serial Numbers... Only 1 Article per line	Prop. Loc.	Rel. Dispo
OV080		(1) "Federal 40 S&W" cartridge case from street	19187030	
OV081		(1) Set of dark grey "Peerless Handcuff Co" handcuffs from street	19187030	
OV082		(1) Silver "Peerless Handcuff" handcuff key from street	19187030	
OV083		(1) "Federal 40 S&W" cartridge case from street	19187030	
OV084		(1) Control and (1) sample swab of possible blood from street	19187030	
OV085		(1) "Speer 223 REM" cartridge from street	19187031	
OV086		(5) "Speer 223 REM" cartridge cases from street	19187031	
OV087		(1) Metal projectile fragment from street	19187031	
OV088		(1) Metal jacket fragment from street	19187031	
OV089		(1) Metal jacket fragment from street	19187031	
OV090		(1) Metal projectile from street	19187031	
OV091		(1) "WMA 16" cartridge case from brush area	19187030	
OV092		(1) "WMA 16" cartridge case from brush area	19187030	
OV093		(1) "Federal 40 S&W" cartridge case from brush area	19187030	
OV094		(1) "Speer 223 REM" cartridge case	19187031	
OV095		(1) "Speer 223 REM" cartridge case	19187031	
OV096		(1) "Speer 223 REM" cartridge case	19187031	
OV097		(1) "Speer 223 REM" cartridge case	19187031	
OV098		(1) "Speer 223 REM" cartridge case	19187031	
OV100		(1) Metal jacketed projectile and multiple metal projectile fragments and metal jacket fragments	19187031	
REA01		(1) Sample swab of sterile collection water	19187030	
VID01		(3 DVD's) Master copy DVD of scene (Do not release)	19187025	
VID02		(2 DVD's) Working copy DVD of scene	MEDIA-E	

* Last Item *

**Riverside Police Department
PROPERTY REPORT**

File No.
190023109

Date/Time
08/12/19 -05:38

Type of Complaint 187 - MURDER		Address Box Springs/ Eastridge Ave			
Victim [REDACTED]	DOB	Sex M	Race White	Address	
Arrestee / Suspect	DOB	Sex	Race	Address	
Arrestee / Suspect	DOB	Sex	Race	Address	
Arrestee / Suspect	DOB	Sex	Race	Address	
Finder Quinn, 1535	DOB	Sex M	Race White	Address 10540 Magnolia Ave - Riverside	Phone No.
[REDACTED]	Supvr. Approving	RMC/RSC Case No.			Property Clerk

Item	Owner	Itemize, Describe, List Serial Numbers... Only 1 Article per line	Prop. Loc.	Rel. Dispo
MOR01		(1) Control and (1) sample swab of possible blood from interior rear passenger seat- Moreno Valley Police Unit (RSO)	19187023	
MOR02		Metal fragment from interior front driver door frame near poss. strike marks B and B1-Moreno Valley Police Unit (RSO)	19187023	
MOR03		Metal jacket and fragment from interior front driver door panel (behind panel)- Moreno Valley Police Unit (RSO)	19187023	
MOR04		Metal fragments from interior front driver door panel (behind panel)- Moreno Valley Police Unit (RSO)	19187023	
MOR05		Metal fragments from interior front driver side of bumper (poss. strike mark A1)- Moreno Valley Police Unit (RSO)	19187023	
MOR06		(1) Sample swab of sterile collection water	19187023	
MOR07		REMINGTON 12 GA PUMP ACTION SHOTGUN MODEL 870 POLICE BBL 18" SN: AB415310M COLOR BLACK (#89 STICKER) S/N: AB415310M / Gun Make: REM - Remington Arms Co., Inc Weapon Type: S - SHOTGUN Weapon Category: P - PUMP ACTION Caliber: 12 Model: 870 POLICE	REL20TH	

* Last Item *



CITY OF RIVERSIDE POLICE DEPARTMENT FORENSIC UNIT

FILE#: 190023109	CRIME: OIS / 187 PC
DATE: 8/13/19	FORENSIC SPECIALIST: [REDACTED]
TIME: 0101 hours / CHP Lincoln Station	OFFICER: CHP Officer [REDACTED]

SEMI-AUTO PISTOL CHART FORM

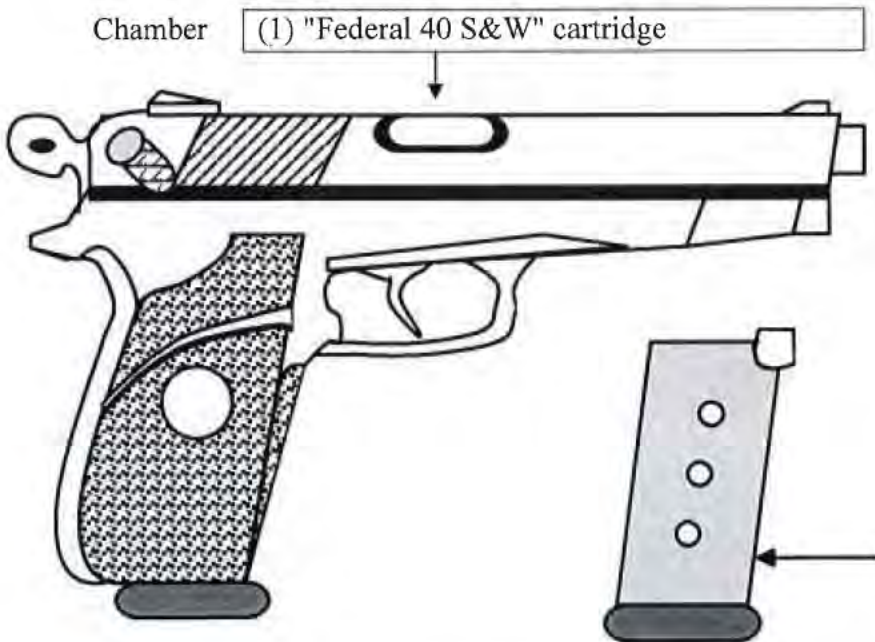

Magazine:
Magazine Capacity: (15)
(1) "Federal 40 S&W" cartridge
(1) "Federal 40 S&W" cartridge
(1) "Federal 40 S&W" cartridge
(1) "Federal 40 S&W" cartridge
(1) "Federal 40 S&W" cartridge
(1) "Federal 40 S&W" cartridge
(1) "Federal 40 S&W" cartridge
(1) "Federal 40 S&W" cartridge
(1) "Federal 40 S&W" cartridge
(1) "Federal 40 S&W" cartridge
(1) "Federal 40 S&W" cartridge
(1) "Federal 40 S&W" cartridge
(1) "Federal 40 S&W" cartridge
(1) "Federal 40 S&W" cartridge
(1) "Federal 40 S&W" cartridge

Brand Name: Smith & Wesson	Hammer Position: N/A
Serial No: JBV8354	Safety Position: N/A
Model: M&P 40	Other Descriptive Info: N/A
Caliber: 40 Caliber	Location Found (How Received): Received from CHP Ofc. [REDACTED] (from holster)

Additional Remarks:

- Det. [REDACTED] assisted with charting.
- CHP [REDACTED] rendered the firearm safe for charting.
- (2) Additional magazines from duty belt (15 cartridge capacity each)
 - (1) Magazine: (7) "Federal 40 S&W" cartridges
 - (1) Magazine: (5) "Federal 40 S&W" cartridges
- CHP [REDACTED] firearm, magazine, (2) additional magazines, cartridges, and uniform pants were collected.
- No back up firearm for CHP Ofc. [REDACTED]



**CITY OF RIVERSIDE POLICE DEPARTMENT
FORENSIC UNIT**

FILE#: 190023109	CRIME: OIS / 187 PC
DATE: 8/13/19	FORENSIC SPECIALIST: [REDACTED]
TIME: 2025	OFFICER: Moreno Valley PD (RSO) Unit 1358192/CA Exempt, Unit 10-004

SHOTGUN CHART FORM



<p>Magazine:</p> <p>Magazine Capacity: 4 Live</p> <p>(1) Live Federal "12 GA" shotgun slug</p> <p>(1) Live Federal "12 GA" shotgun slug</p> <p>(1) Live Federal "12 GA" shotgun slug</p> <p> </p> <p> </p> <p> </p> <p> </p> <p> </p> <p> </p> <p> </p> <p> </p>
--

Brand Name: Remington	Hammer Position: N/A
Serial No: T354780V or Y (#54 sticker)	Safety Position: On
Model: Unknown	Other Descriptive Info: Black sling attached to firearm.
Caliber: 12 GA	Location Found (How Received): Secured shotgun rack between front driver and front passenger seats.

Additional Remarks:

- Det. [REDACTED] rendered the firearm safe and assisted with charting.
- (3) Live Federal "12 GA" shotgun slugs removed from magazine tube.
- (2) Live "Federal 12 GA" buckshot shotgun shells removed from stock pouch on right side of firearm.
- (2) Live "Federal 12 GA" buckshot shotgun shells removed from stock pouch on left side of firearm.
- (6) Live Federal "12 GA" shotgun slugs removed from side saddle of firearm.
- Firearm and live shotgun shells were released back to the Moreno Valley PD (RSO) Unit 10-004 at scene.



**CITY OF RIVERSIDE POLICE DEPARTMENT
FORENSIC UNIT**

FILE#: 190023109	CRIME: OIS / 187 PC
DATE: 8/12/19	FORENSIC SPECIALIST: [REDACTED]
TIME: 2315 hours / Magnolia Station	OFFICER: RPD Officer K. Feimer #1001

SEMI-AUTO PISTOL CHART FORM

Chamber (1) "WIN 40 S&W" cartridge



Magazine:
Magazine Capacity: (15)
(1) "WIN 40 S&W" cartridge
(1) "WIN 40 S&W" cartridge
(1) "WIN 40 S&W" cartridge
(1) "WIN 40 S&W" cartridge
(1) "WIN 40 S&W" cartridge
(1) "WIN 40 S&W" cartridge
(1) "WIN 40 S&W" cartridge
(1) "WIN 40 S&W" cartridge
(1) "WIN 40 S&W" cartridge
(1) "WIN 40 S&W" cartridge
(1) "WIN 40 S&W" cartridge
(1) "WIN 40 S&W" cartridge
(1) "WIN 40 S&W" cartridge
(1) "WIN 40 S&W" cartridge
(1) "WIN 40 S&W" cartridge

Brand Name: Glock	Hammer Position: N/A
Serial No: WDR085	Safety Position: N/A
Model: 22	Other Descriptive Info: TLR Streamlight attached to firearm (pressure switch for light)
Caliber: 40 Caliber	Location Found (How Received): Received from RPD Ofc. Feimer (from holster)

Additional Remarks:
 -Sgt. Simons assisted with charting.
 -RPD Ofc. Feimer rendered the firearm safe for charting.
 -(2) Additional magazines on duty belt (15 cartridge capacity for each)
 (1) Magazine: (15) "WIN 40 S&W" cartridges
 (1) Magazine: (15) "WIN 40 S&W" cartridges
 -Firearm, magazine, additional magazines, and cartridges released back to RPD Ofc. Feimer.
 -No back up firearm for RPD Ofc. Feimer.



**CITY OF RIVERSIDE POLICE DEPARTMENT
FORENSIC UNIT**

FILE#: 190023109	CRIME: 187 PC ON A P.O.
DATE: 8/14/2019	FORENSIC SPECIALIST: [REDACTED]
TIME: 0120	RSO UNIT: 18-003

SHOTGUN CHART FORM

Chamber → EMPTY

Magazine:
Magazine Capacity:
UNKNOWN
(4) 12 GAUGE SHOTGUN SHELLS

Brand Name: REMINGTON	Hammer Position: NONE
Serial No: AB552938 M	Safety Position: -
Model: UNKNOWN	Other Descriptive Info: SIDE SADDLE, "45" TAPED TO BOTTOM OF GRIP
Caliber: 12 GAUGE	Location Found (How Received): CENTER CONSOLE GUN RACK OF RSO UNIT #18-003

Additional Remarks:
 -SHOTGUN WAS RENDERED SAFE AND WEAPON CHARTING ASSISTED BY DETECTIVE [REDACTED]
 -SIDE SADDLE CONTAINED: (6) 12 GAUGE SHOTGUN SHELLS
 -BUTTSTOCK STORAGE COMPARTMENTS CONTAINED: (4) TOTAL 12 GAUGE SHOTGUN SHELLS
 -SHOTGUN WAS RELEASED TO RSO UNIT #18-003, AT APPROXIMATELY 0130 HOURS



Riverside Police Department

Officer Report

File Number:
190023109-063

Administrative Information

Subject:	1111 - OFFICER NEEDS BACK-UP/URGENT RESPONSE				
Date(s) and Time(s) of Occurrence Or Between:	//				
Location Of Occurrence:	Box Springs Bldg / Eastridge Ave RIVERSIDE				
Date/Time Reported:	8/12/2019 5:38:06 PM	Day:			
Date Of Report:	8/20/2019 3:34:24 PM	Type Of Premises:			
NPC:		RD:	PG08	Beat:	3
Was There a Witness To The Crime?					
Can a Suspect Be Named Or Identified?		By Whom?			
Can a Suspect Vehicle Be Identified?		By Whom?			

Code Section Classification:

Records Section

Reporting Officer:	[REDACTED]		
115 Qualified:	Yes		
Send Copies Of This Report To:			
DOJ/NCIC Entered?		Name/ID	
DOJ/NCIC Cancelled?		Name/ID	
APR Sent?		Name/ID	
APB Sent?		Name/ID	

Public Narrative

Supervisor Approving

Approving Supervisor:	[REDACTED]
Date Reviewed:	8/22/2019 12:00:00 AM

Evidence Information

Physical Evidence Present?		Physical Evidence Seized?	
----------------------------	--	---------------------------	--



Riverside Police Department

Officer Report

File Number:
190023109-063

Photographs Taken?		Photographer?	
Weapon Seized?		Weapon(s) Taken For Safety?	
Gang Related?		Sensitive Data?	
Fingerprint Search Made?		Fingerprints Obtained?	
Narcotics Seized?		Narcotics Field Tested?	
Audio Recording Available?		In Car Recording Available?	
Body Worn Camera Recording Available?			
Type of Weapon, Force, Or Device Used?			
Motive:			

Narrative

1 **SUMMARY:**

2 This Officer Report covers my observations during the autopsy. Refer to Autopsy
3 Protocol for further details.

4
5 **RPD PERSONNEL IN ATTENDANCE:**

6 Senior Forensic Evidence Specialist [REDACTED] yer

7
8 **AUTOPSY BOARD INFORMATION:**

9 **Date:** 08-13-19

10 **Name:** Moye, Andre

11 **Case#:** 2019-09734

12 **Start Time:** 0912 hours

13 **End Time:** 1104 hours

14 **Seal #:** 053202 **Broken at:** 0912 hours

15 **Age:** 34

16 **Eyes:** Brown

17 **Hair:** Brown

18 **Ht:** 72"

19 **Wt:** 193 lbs.

20 **Doc:** [REDACTED]

21 **For Tec:** [REDACTED]

22 **Cor Tec:** [REDACTED]

23 **COD:** Gunshot wounds of Head & Neck

24
25 **OBSERVATIONS:**

26 I observed the autopsy from inside the autopsy viewing room. Senior Forensic
27 Evidence Specialists [REDACTED] was in the autopsy room. Moye was on the exam table in a



Riverside Police Department

Officer Report

File Number:
190023109-063

28 sealed white body bag. The seal on Moye's body bag was broken at 0912 hours.
29 There was medical intervention equipment on Moye's body.

30

31 **Clothing**

32 None. Moye's clothing and equipment was collected at RUHSMC in the ER.

33

34 **Injuries**

35 Dr. [REDACTED] conducted the external examination. I noted the following injuries: a
36 gunshot entry type wound (GSW) to the left side of his head to the front of left ear, a
37 gunshot type exit wound to the right side of his head near the temple area, a through
38 and through GSW to his left wrist, and a GSW to the back of left shoulder (see photos
39 for details).

40

41 Dr. [REDACTED] then conducted the internal examination. She indicated the right side of
42 Moye's skull was fractured and there were bullet fragments on the right side of the skull.
43 She also located bullet fragments in the left side of Moye's neck from the GSW to the
44 back of left shoulder (see photos for details).

45

46 **ITEMS COLLECTED:**

47 I observed the listed items being collected by Senior Forensic Evidence Specialist
48 [REDACTED] (see her Officer Report for complete details on all the evidence collected and the
49 photographs provided by Coroner Forensic Specialist [REDACTED]:

50

- 51 · DNA/Blood card
- 52 · Metal fragments from right temporal side
- 53 · Metal fragments from right temporal side of brain
- 54 · Lead projectile and fragments from left side of neck

55

56 **CONCLUSION:**

57 The autopsy concluded at 1104 hours. The COD (Cause of Death) was listed as:
58 Gunshot wounds of head and neck. Refer to Autopsy Protocol for complete details.

59

60 **No further information.**

61

Date Printed: 10/30/2022 11:29	Case Report Number: 190023109-063	Page: 3 of 3	Ver. 1.3.3
--	---	------------------------	----------------------



Riverside Police Department

Officer Report

File Number:
190023109-072

Administrative Information

Subject:	1111 - OFFICER NEEDS BACK-UP/URGENT RESPONSE				
Date(s) and Time(s) of Occurrence Or Between:	//				
Location Of Occurrence:	Box Springs Bldg / Eastridge Ave RIVERSIDE				
Date/Time Reported:	8/12/2019 5:38:06 PM	Day:			
Date Of Report:	8/29/2019 8:14:46 AM	Type Of Premises:			
NPC:		RD:	PG08	Beat:	3
Was There a Witness To The Crime?					
Can a Suspect Be Named Or Identified?			By Whom?		
Can a Suspect Vehicle Be Identified?			By Whom?		

Code Section Classification:

Records Section

Reporting Officer:	[REDACTED]		
115 Qualified:	No		
Send Copies Of This Report To:			
DOJ/NCIC Entered?		Name/ID	
DOJ/NCIC Cancelled?		Name/ID	
APR Sent?		Name/ID	
APB Sent?		Name/ID	

Public Narrative

Supervisor Approving

Approving Supervisor:	[REDACTED]
Date Reviewed:	9/9/2019 12:00:00 AM

Evidence Information

Physical Evidence Present?		Physical Evidence Seized?	
----------------------------	--	---------------------------	--



Riverside Police Department

Officer Report

File Number:
190023109-072

Photographs Taken?	Yes	Photographer?	[REDACTED]
Weapon Seized?		Weapon(s) Taken For Safety?	No
Gang Related?	Unknown	Sensitive Data?	Yes
Fingerprint Search Made?	No	Fingerprints Obtained?	N/A
Narcotics Seized?		Narcotics Field Tested?	No
Audio Recording Available?	No	In Car Recording Available?	No
Body Worn Camera Recording Available?	No		
Type of Weapon, Force, Or Device Used?			
Motive:			

Narrative

1 **Case Type:**

2 187 PC / Homicide
3 OIS / Officer Involved Shooting
4

5 **Service Requested:**

6 On 08/13/19, at approximately 0900 hours, at the request of [REDACTED], I
7 responded to the Riverside County Coroner's Office, 800 S. Redlands Blvd, Perris CA, in order
8 to attend a [REDACTED] autopsy for victim, MOYE, ANDRE (DOB 04-15-85). The attending
9 physician was DR. [REDACTED]. Also present were RSO FORENSIC TECHNICIAN [REDACTED]
[REDACTED] and CORONER TECHNICIAN [REDACTED]

11

12 **Photographs Taken:**

13 Digital photographs, of MOYE and his injuries, were taken by RSO FORENSIC TECHNICIAN
14 [REDACTED].

15

16 **Evidence Received:**

17 At approximately 1108 hours, I received a number of evidence items, collected by RSO
18 CORONER TECHNICIAN [REDACTED]. These items included; a DNA/blood card, a metal
19 fragment (labeled, right temporal side), a metal fragment (labeled, right temporal side of brain),
20 and a lead projectile with fragments (labeled, left side of neck). These items were packaged and
21 labeled MOY001-MOY004.

22

23 At approximately 1130 hours, I completed my assignment and returned to the Magnolia Station,
24 Forensic Unit. All items were immediately secured in the Forensic Unit Evidence Vault.

25

26 **Evidence Disposition:**



Riverside Police Department

Officer Report

File Number:
190023109-072

27 On 08/15/19, at approximately 1507 hours, I removed each of the above listed items from the
28 Evidence Vault and released them to Magnolia Station Property Locker #44.

29

30 **Photographs Received / Uploaded:**

31 On 08/16/19 at approximately 0800 hours, I returned to the Riverside County Coroners Office in
32 order to pick up the CD of digital photographs. I received the CD of images from the front office
33 staff. These (207) photographs were uploaded into the Digital Information Management System
34 (DIMS). The original CD was then packed and labeled CD001.

35

36 On 8/20/19 at approximately 1207 hours, the original CD was released to Property Locker #43.
37 Please see my attachments (*Property Report and Evidence Log*) for further.

38

39 No further action was taken.

40

41

RIVERSIDE POLICE DEPARTMENT

Date Printed: 10/30/2022 11:40	Case Report Number: 190023109-072	Page: 3 of 3	Ver. 1.3.3
-----------------------------------	--------------------------------------	-----------------	---------------



Riverside Police Department

Officer Report

File Number:
190023109-064

Administrative Information

Subject:		1111 - OFFICER NEEDS BACK-UP/URGENT RESPONSE			
Date(s) and Time(s) of Occurrence Or Between:		//			
Location Of Occurrence:		Box Springs Bldg / Eastridge Ave RIVERSIDE			
Date/Time Reported:	8/12/2019 5:38:06 PM	Day:			
Date Of Report:	8/20/2019 4:08:13 PM	Type Of Premises:			
NPC:		RD:	PG08	Beat:	3
Was There a Witness To The Crime?					
Can a Suspect Be Named Or Identified?		By Whom?			
Can a Suspect Vehicle Be Identified?		By Whom?			

Code Section Classification:

Records Section

Reporting Officer:	[REDACTED]				
115 Qualified:	Yes				
Send Copies Of This Report To:					
DOJ/NCIC Entered?		Name/ID			
DOJ/NCIC Cancelled?		Name/ID			
APR Sent?		Name/ID			
APB Sent?		Name/ID			

Public Narrative

Supervisor Approving

Approving Supervisor:	[REDACTED]				
Date Reviewed:	8/22/2019 12:00:00 AM				

Evidence Information

Physical Evidence Present?		Physical Evidence Seized?	
----------------------------	--	---------------------------	--



Riverside Police Department

Officer Report

File Number:
190023109-064

Photographs Taken?		Photographer?	
Weapon Seized?		Weapon(s) Taken For Safety?	
Gang Related?		Sensitive Data?	
Fingerprint Search Made?		Fingerprints Obtained?	
Narcotics Seized?		Narcotics Field Tested?	
Audio Recording Available?		In Car Recording Available?	
Body Worn Camera Recording Available?			
Type of Weapon, Force, Or Device Used?			
Motive:			

Narrative

1 **SUMMARY:**

2 This Officer Report covers my observations during the autopsy which took place at
3 the Indio Facility. Refer to Autopsy Protocol for further details.

4
5 **RPD PERSONNEL IN ATTENDANCE:**

6 Senior Forensic Evidence Specialist [REDACTED]

7
8 **AUTOPSY BOARD INFORMATION:**

9 **Date:** 08-14-19

10 **Name:** Luther, Aaron

11 **Case#:** 2019-09736

12 **Start Time:** 1010 hours

13 **End Time:** 1254 hours

14 **Seal #:** 053256 **Broken at:** 1027 hours

15 **Age:** 49

16 **Eyes:** Brown

17 **Hair:** Brown

18 **Ht:** 69"

19 **Wt:** 214 lbs.

20 **Doc:** [REDACTED]

21 **For Tec:** [REDACTED]

22 **Cor Tec:** [REDACTED]

23 **COD:** Pending Coroner's Review

24
25 **OBSERVATIONS:**

26 I observed the autopsy from inside the autopsy viewing room. Senior Forensic
27 Evidence Specialists [REDACTED] was also in the viewing room. Luther was on the exam table



Riverside Police Department

Officer Report

File Number:
190023109-064

28 in a sealed white body bag. The seal on Luther's body bag was broken at 1027 hours.
29 There was medical intervention equipment on Luther's body.

30
31

Clothing

32 None. Luther's clothing was collected at RUHSMC in the ER and at the crime scene.

34

Injuries

35 Dr. [REDACTED] conducted the external examination. She noted the following injuries:
36 a gunshot entry type wound to the right chest with an exit type wound to the right back,
37 a through and through entry and exit type wound to the upper right arm (front to back),
38 and an entry type wound to the upper left thigh with an exit type wound to the lower left
39 thigh. She also noted other injuries to the following areas: left chest, mid line pelvis,
40 right wrist, right second finger, upper right arm, right elbow, right knee, right ankle, left
41 upper arm, left forearm, and left hand (see photos for details).

42

43
44 Dr. [REDACTED] then conducted the internal examination. She indicated Luther's right
45 lung was injured by the bullet that traveled through his chest, and there were bullet
46 fragments in his left hand and left leg (see photos for details).

47

ITEMS COLLECTED:

48 The listed items were given to Senior Forensic Evidence Specialist [REDACTED] by Coroner
49 Tech [REDACTED] (see her Officer Report for complete details on all the evidence
50 collected and the photographs provided by the Coroner's Office):

51

- 52 · DNA/Blood card
- 53 · Metal fragments from left hand
- 54 · Metal fragments from left leg

55

CONCLUSION:

56
57 The autopsy concluded at 1254 hours. The COD (Cause of Death) was listed as:
58 Pending Coroner's Review. Refer to Autopsy Protocol for complete details.

59

60
61 **No further information.**

62



Riverside Police Department

Officer Report

File Number:
190023109-073

Administrative Information

Subject:	1111 - OFFICER NEEDS BACK-UP/URGENT RESPONSE				
Date(s) and Time(s) of Occurrence Or Between:	//				
Location Of Occurrence:	Box Springs Bldg / Eastridge Ave RIVERSIDE				
Date/Time Reported:	8/12/2019 5:38:06 PM	Day:			
Date Of Report:	8/29/2019 10:42:34 AM	Type Of Premises:			
NPC:		RD:	PG08	Beat:	3
Was There a Witness To The Crime?					
Can a Suspect Be Named Or Identified?		By Whom?			
Can a Suspect Vehicle Be Identified?		By Whom?			

Code Section Classification:

Records Section

Reporting Officer:	[REDACTED]		
115 Qualified:	No		
Send Copies Of This Report To:			
DOJ/NCIC Entered?		Name/ID	
DOJ/NCIC Cancelled?		Name/ID	
APR Sent?		Name/ID	
APB Sent?		Name/ID	

Public Narrative

Supervisor Approving

Approving Supervisor:	[REDACTED]
Date Reviewed:	9/9/2019 12:00:00 AM

Evidence Information

Physical Evidence Present?		Physical Evidence Seized?	
----------------------------	--	---------------------------	--



Riverside Police Department

Officer Report

File Number:
190023109-073

Photographs Taken?	Yes	Photographer?	1913 - Meyer, Rebecca
Weapon Seized?		Weapon(s) Taken For Safety?	No
Gang Related?	No	Sensitive Data?	Yes
Fingerprint Search Made?	No	Fingerprints Obtained?	N/A
Narcotics Seized?		Narcotics Field Tested?	No
Audio Recording Available?	No	In Car Recording Available?	No
Body Worn Camera Recording Available?	No		
Type of Weapon, Force, Or Device Used?			
Motive:			

Narrative

- 1 **Case Type:**
- 2 187 PC / Homicide
- 3 OIS / Officer Involved Shooting
- 4
- 5 **Service Requested:**
- 6 On 08/14/19, at approximately 1000 hours, myself and [REDACTED] responded to the
- 7 Riverside County Coroner's Office, 47225 Oasis Street, Indio CA, in order to attend a scheduled
- 8 autopsy for suspect, LUTHER, AARON (DOB 03-23-70). The attending physician was DR.
- 9 [REDACTED] Also present were RSO FORENSIC TECHNICIAN [REDACTED] and
- 10 CORONER TECHNICIAN [REDACTED].
- 11
- 12 **Photographs Taken:**
- 13 Digital photographs of LUTHER and his injuries were taken by RSO FORENSIC
- 14 TECHNICIAN [REDACTED].
- 15
- 16 **Evidence Received:**
- 17 At approximately 1255 hours, I received a number of evidence items, collected by CORONER
- 18 TECH [REDACTED] These items included; a DNA/blood card, a metal fragment (labeled,
- 19 hand) and a metal fragment (labeled, leg). These items were packaged and labeled LUTH001-
- 20 LUTH003.
- 21
- 22 At approximately 1300 hours, I completed my assignment. All items remained in my possession
- 23 until approximately 1530 hours, when I secured each of the above listed items in the Forensic
- 24 Unit Evidence Vault.
- 25
- 26 **Evidence Disposition:**



Riverside Police Department

Officer Report

File Number:
190023109-073

27 On 08/15/19, at approximately 1507 hours, I removed each of the above listed items from the
28 Evidence Vault and released them to Magnolia Station Property Locker #44.

29

30 **Photographs Received / Uploaded:**

31 On 08/16/19 at approximately 0800 hours, I returned to the Riverside County Coroner's Office,
32 in order to pick up the CD of digital photographs. I received the CD of images from the front
33 office staff. These (268) photographs were uploaded into the Digital Information Management
34 System (DIMS). The original CD was then packed and labeled CD002.

35

36 On 08/20/19 at approximately 1207 hours, the original CD was released to Property Locker #43.
37 Please see my attachments (*Property Report and Evidence Log*) for further.

38

39 No further action was taken.

40

RIVERSIDE POLICE DEPARTMENT

Date Printed: 10/30/2022 11:42	Case Report Number: 190023109-073	Page: 3 of 3	Ver. 1.3.3
-----------------------------------	--------------------------------------	-----------------	---------------

TABLE OF CONTENTS THUMBNAILS

	Description	Notes
1	BUILDING STRIKES (Pages 1 - 9)	PHOTOS
2	HELICOPTER REDACTED (Pages 1)	PHOTOS
3	KFEIMER (Pages 1 - 3)	PHOTOS
4	ON SCENE 1 (Pages 1 - 12)	PHOTOS
5	ON SCENE 2 (Pages 1 - 12)	PHOTOS
6	ON SCENE 3 (Pages 1 - 13)	PHOTOS
7	ON SCENE 4 (Pages 1 - 11)	PHOTOS
8	ON SCENE 5 (Pages 1 - 12)	PHOTOS
10	ON SCENE 6 (Pages 1 - 6)	PHOTOS
11	ORANGE SAFETY JACKET (Pages 1 - 8)	PHOTOS
12	VEHICLE 1 (Pages 1 - 16)	PHOTOS
13	VEHICLE 2 (Pages 1 - 16)	PHOTOS
14	VEHICLE 3 (Pages 1 - 23)	PHOTOS
15	VEHICLE 4 (Pages 1 - 29)	PHOTOS
16	VEHICLE 5 (Pages 1 - 17)	PHOTOS
17	VEHICLE 6 (Pages 1 - 13)	PHOTOS
18	VEHICLE 7 (Pages 1 - 19)	PHOTOS
19	VEHICLE 8 (Pages 1 - 16)	PHOTOS
20	VEHICLE 9 (Pages 1 - 18)	PHOTOS
21	VEHICLE 10 (Pages 1 - 12)	PHOTOS
22	VEHICLE 11 (Pages 1 - 23)	PHOTOS

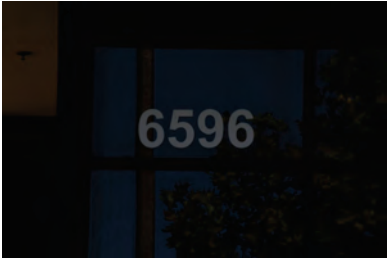



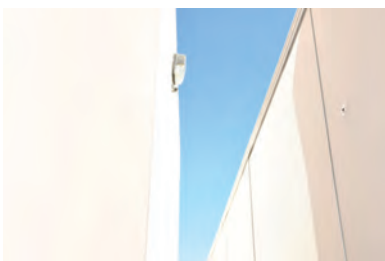

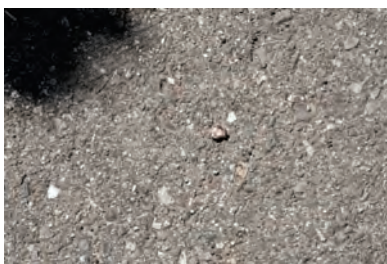
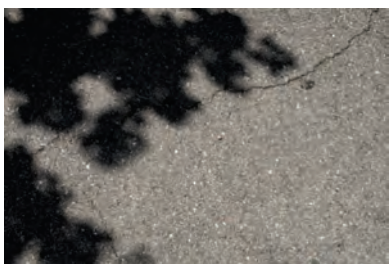
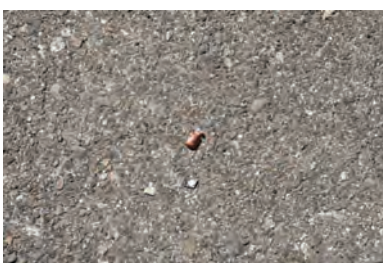
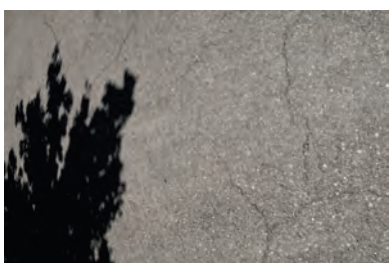

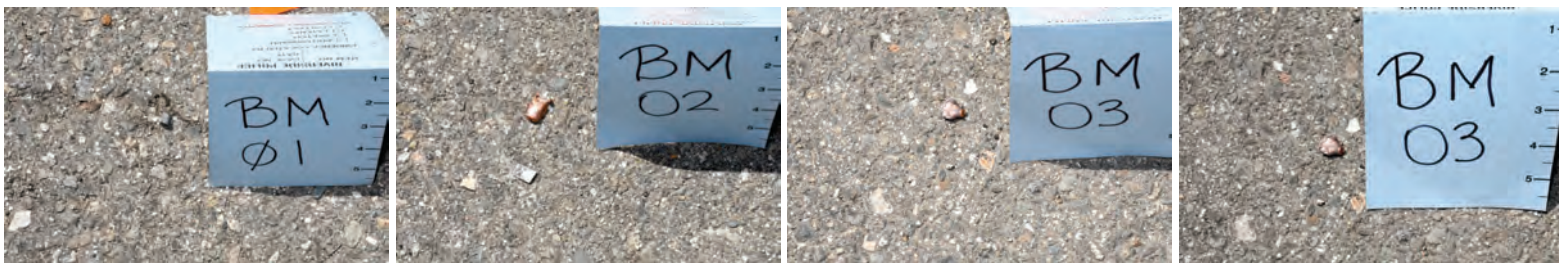

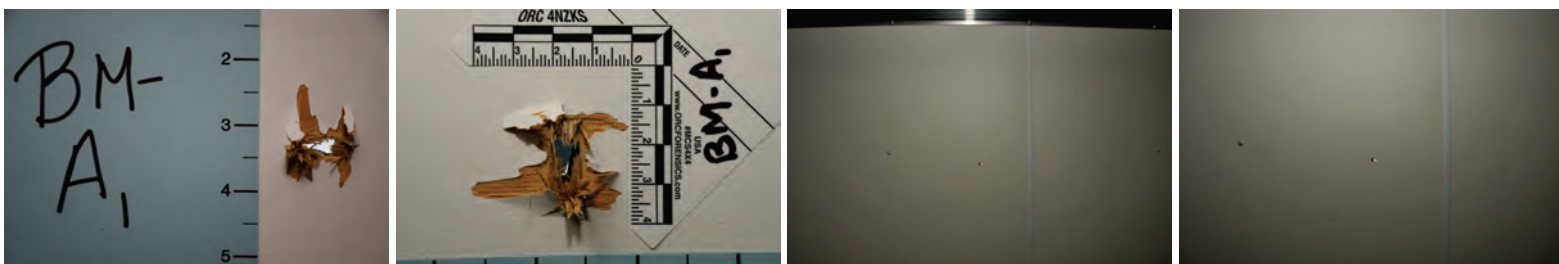
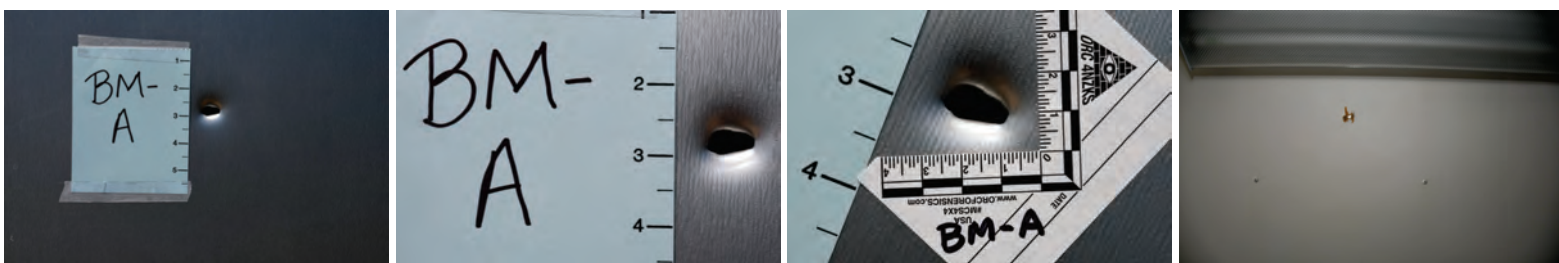
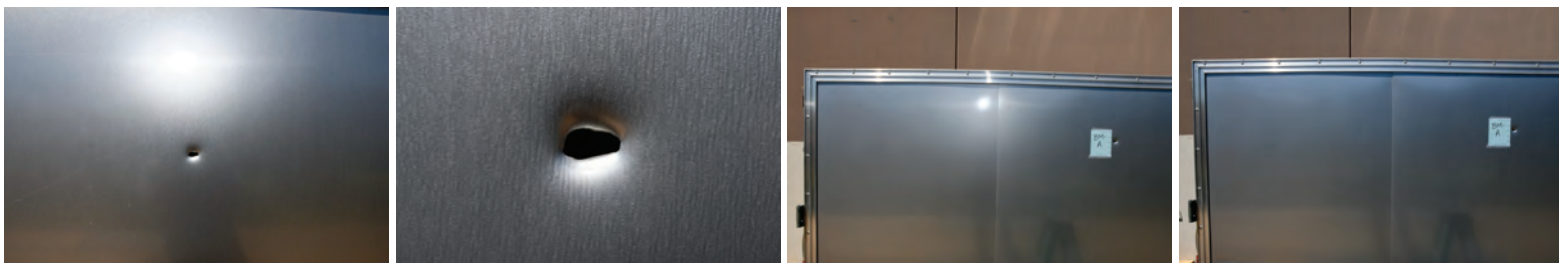

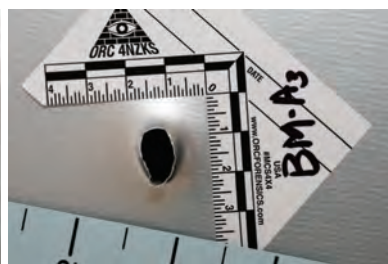
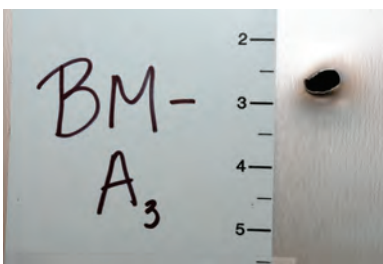
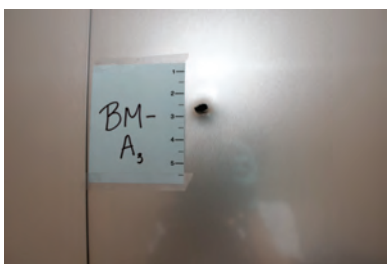
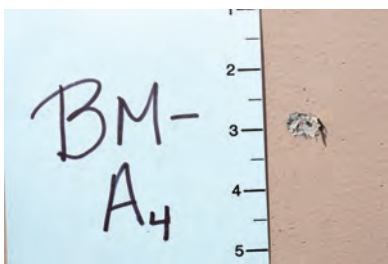
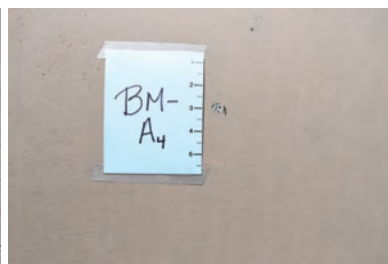
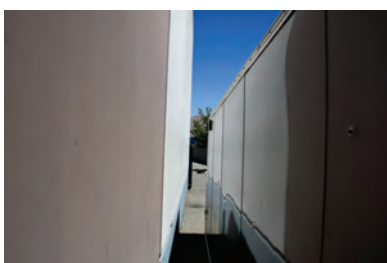
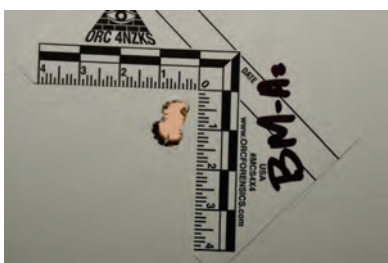
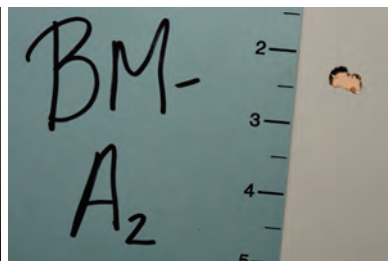
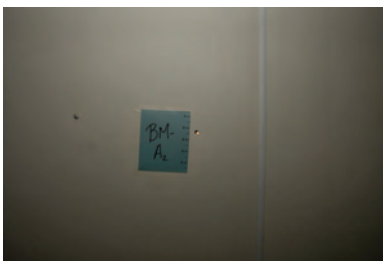
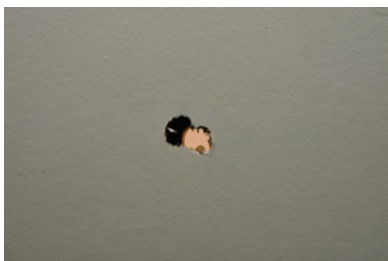

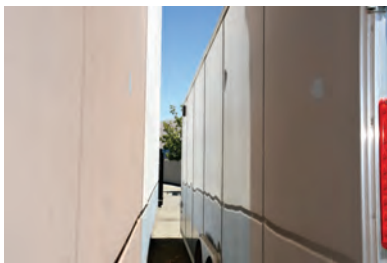
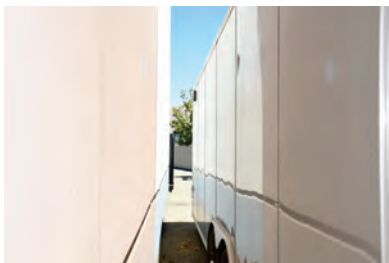
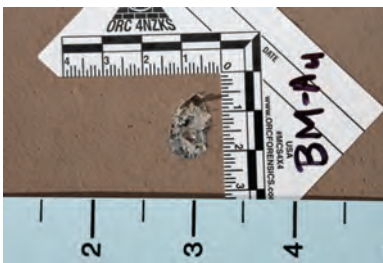
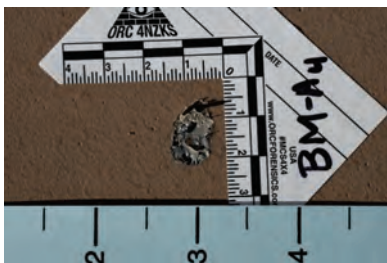
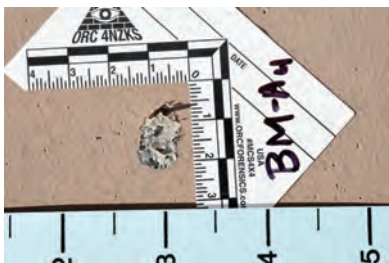

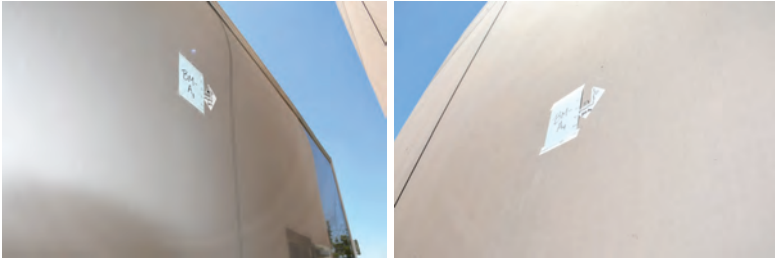

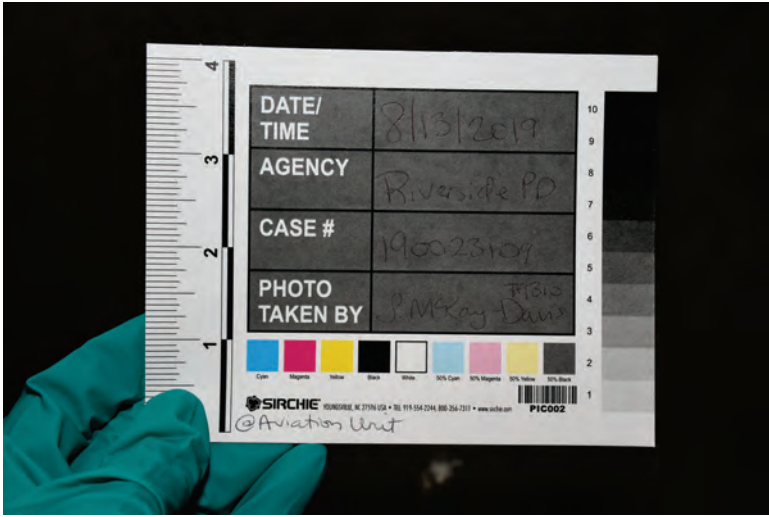

190023109
K. FEIMER #1001
8/12/19
O.I.S.

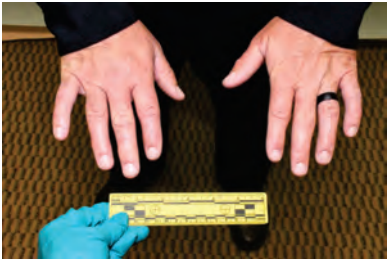









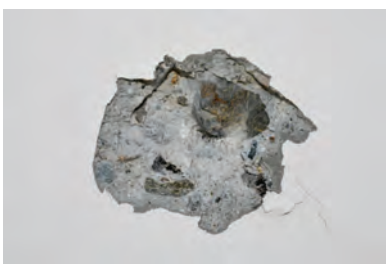

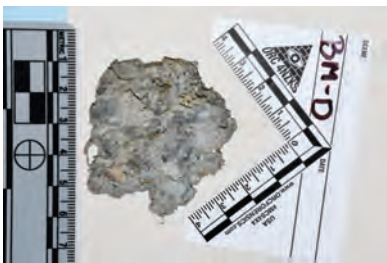
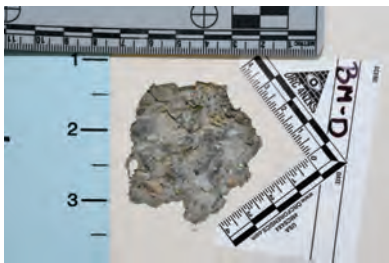
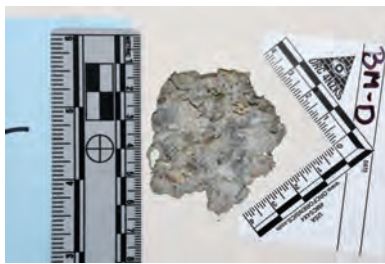
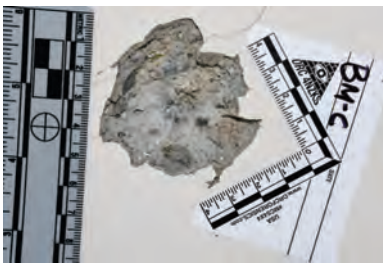
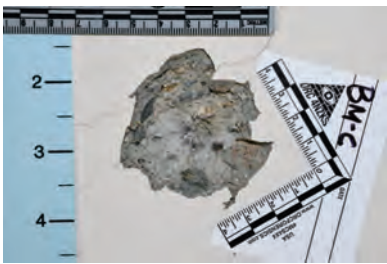
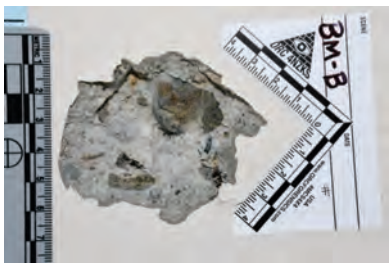
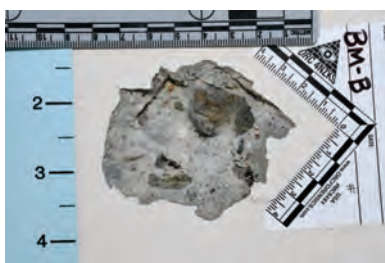
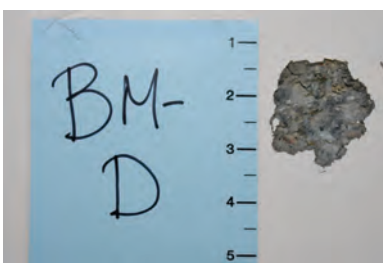
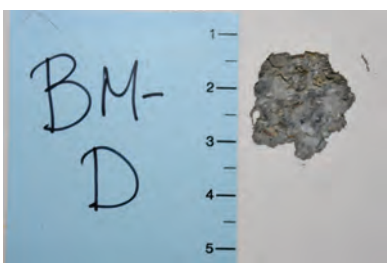
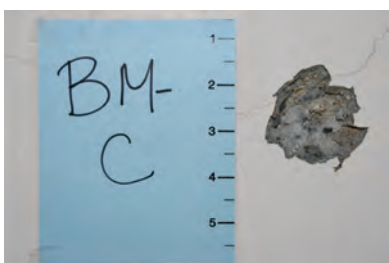
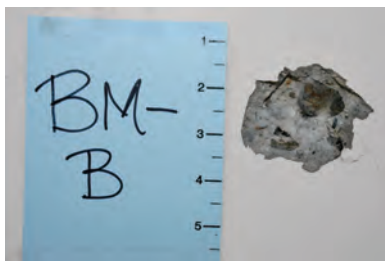
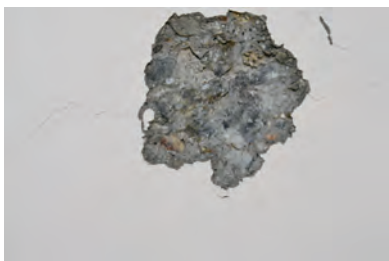



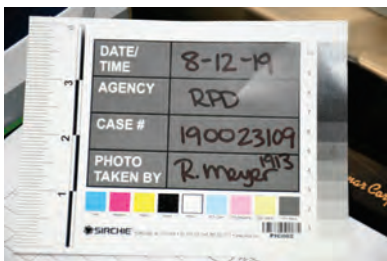

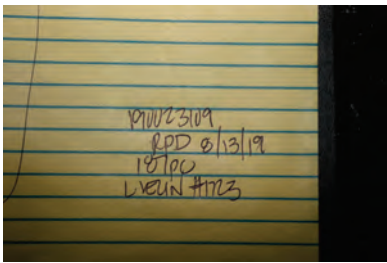

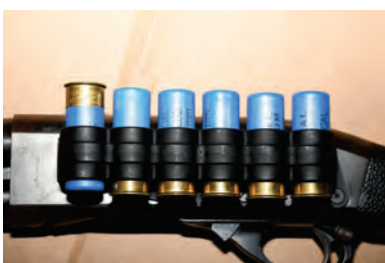

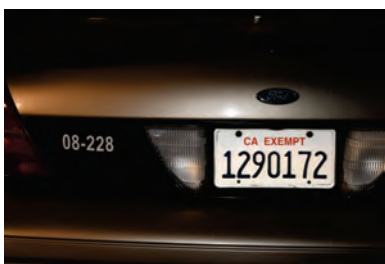
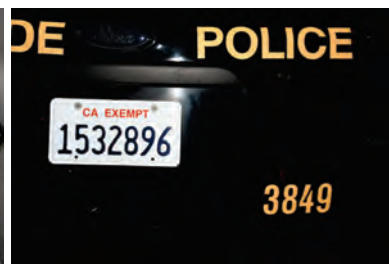

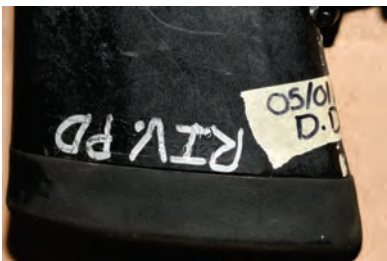

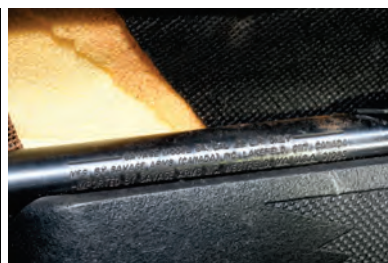
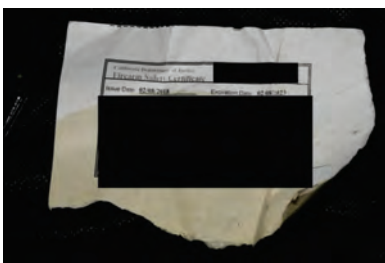





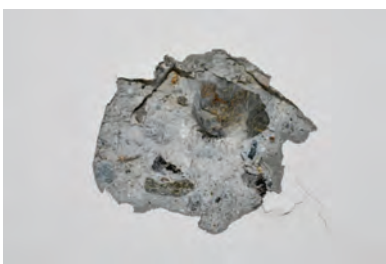

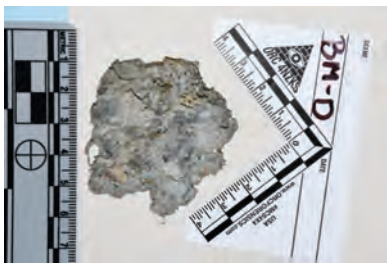
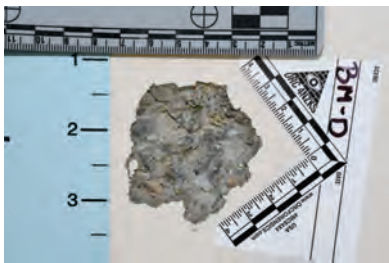
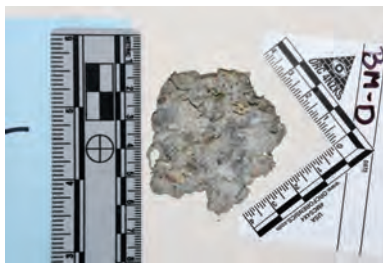
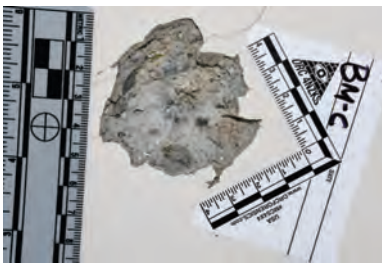
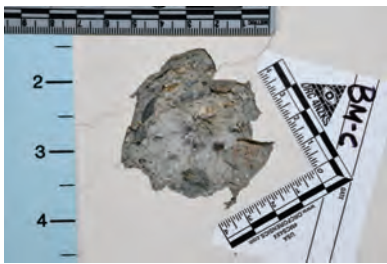
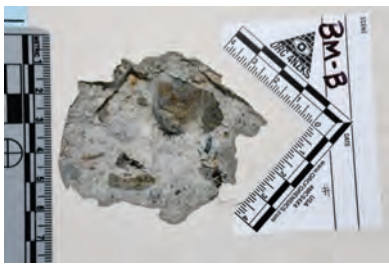
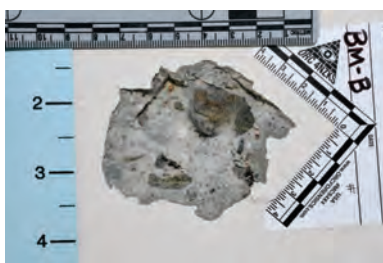
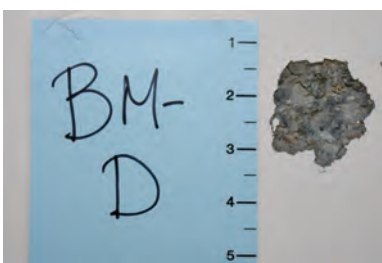
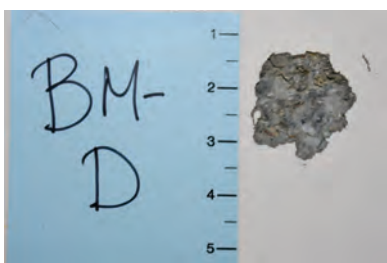
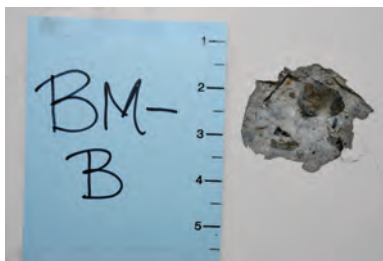
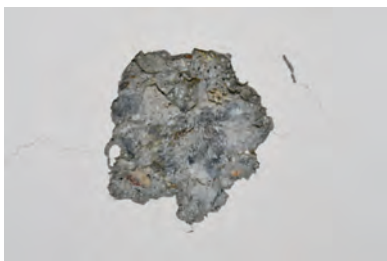
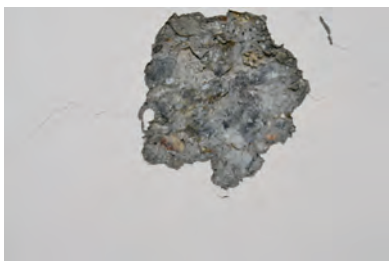

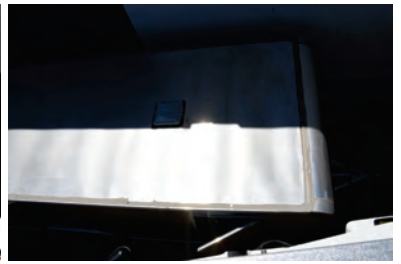

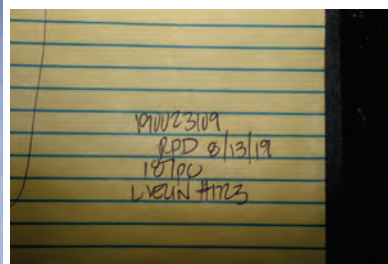
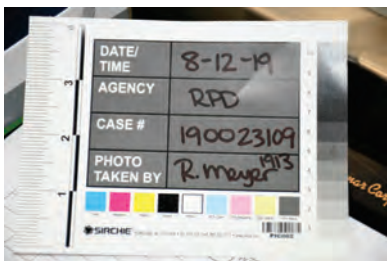





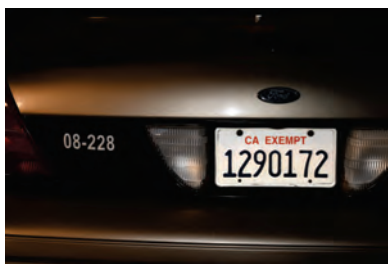
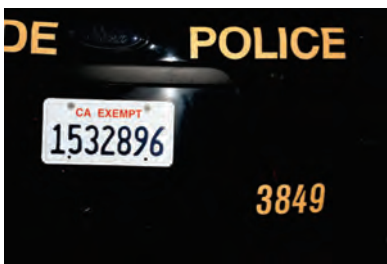

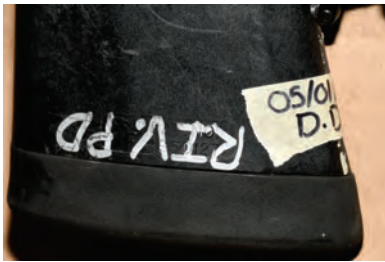

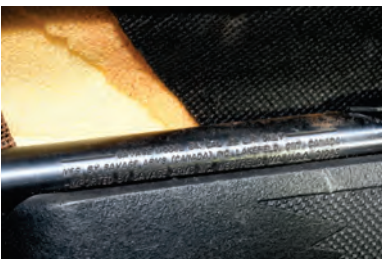
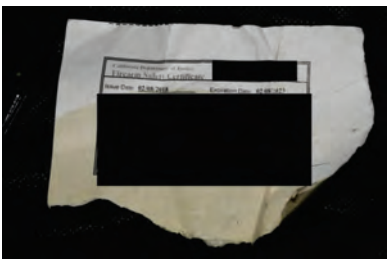









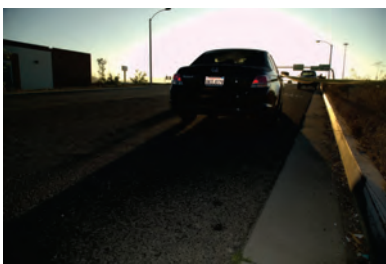









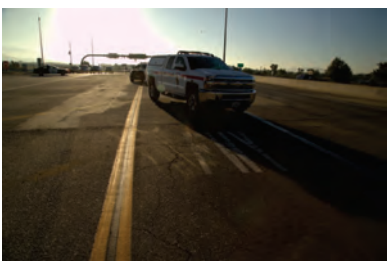
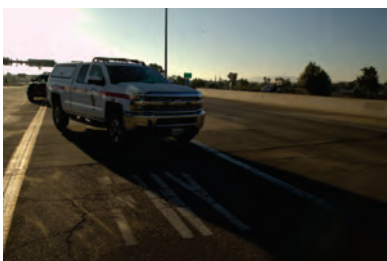



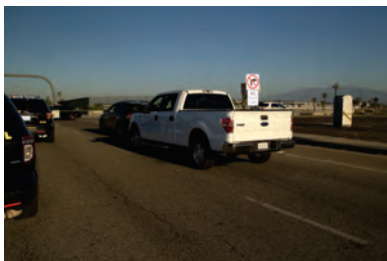
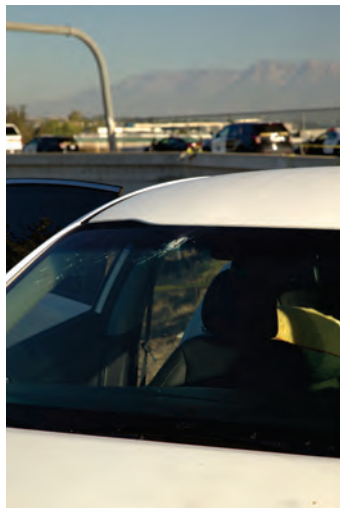









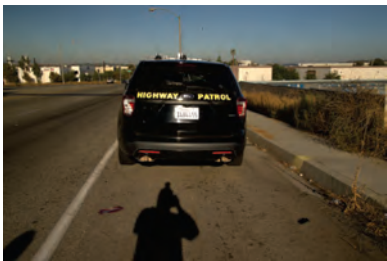

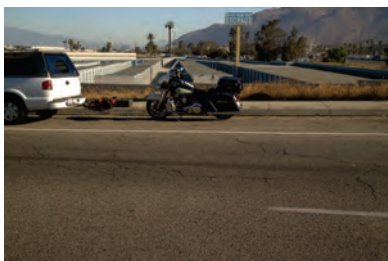

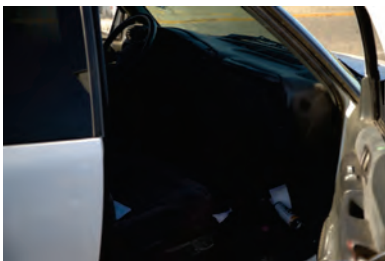

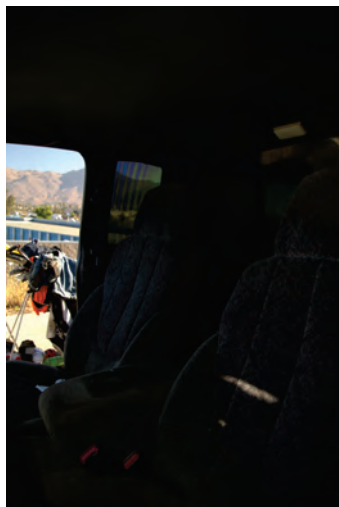





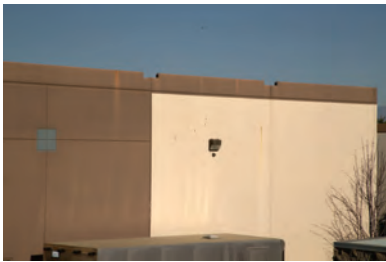
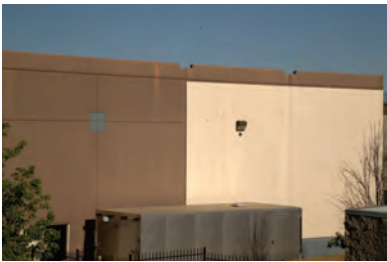





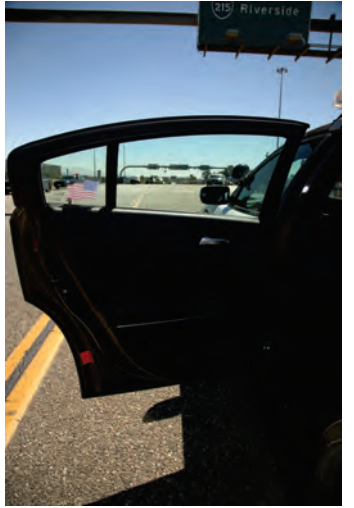
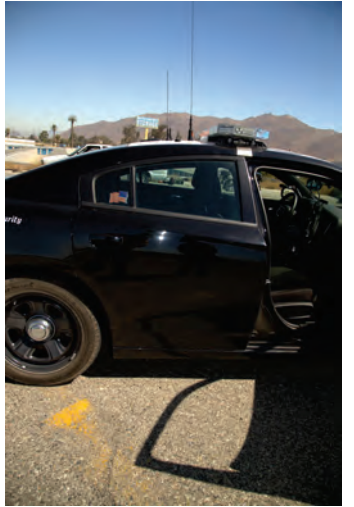

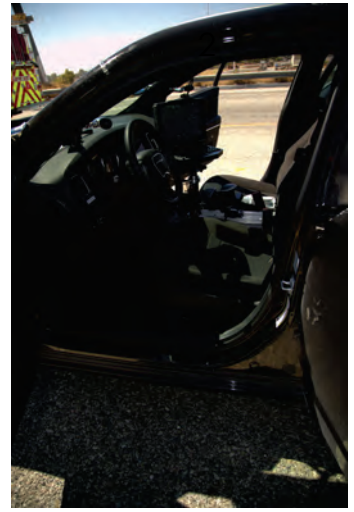



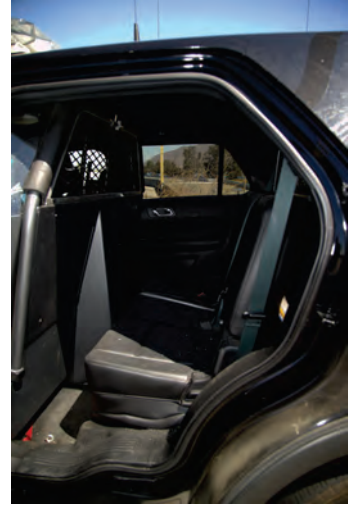

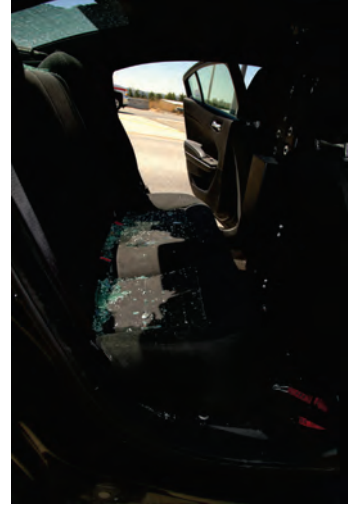
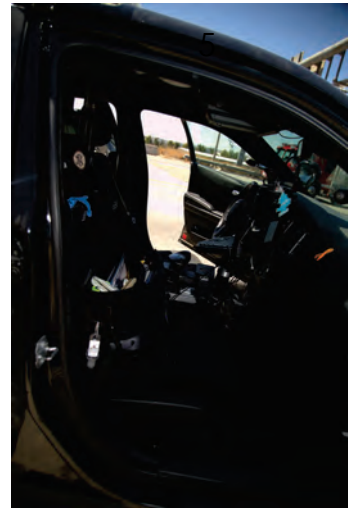



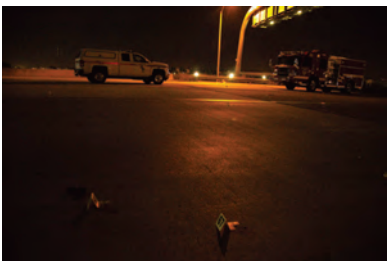
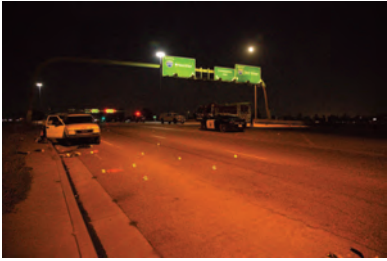
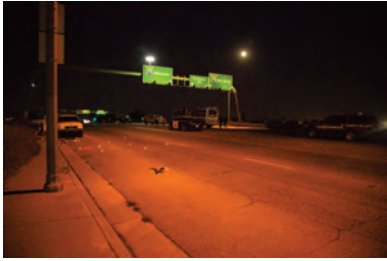

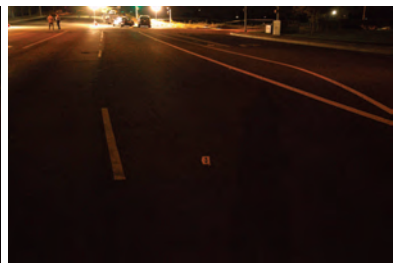
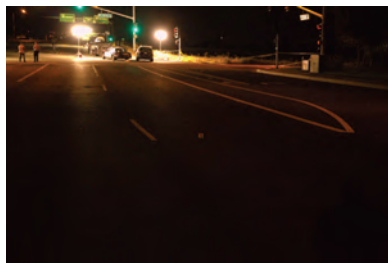
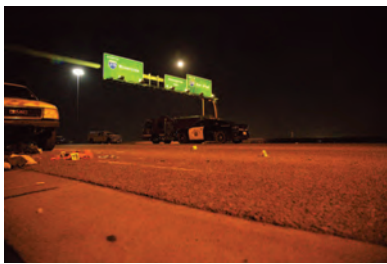

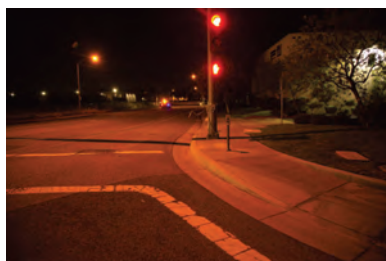
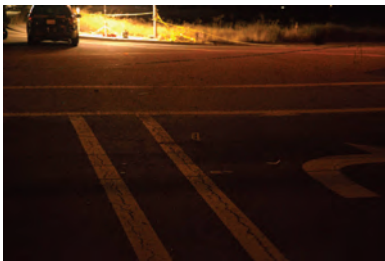

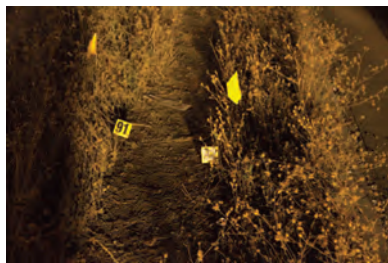
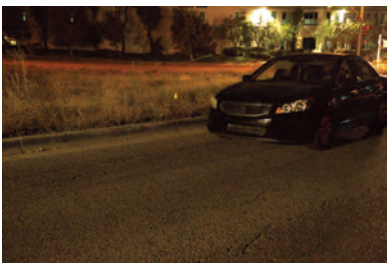
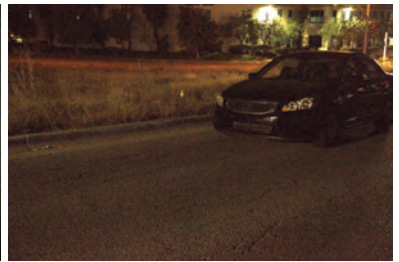

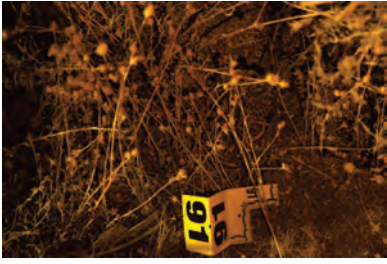



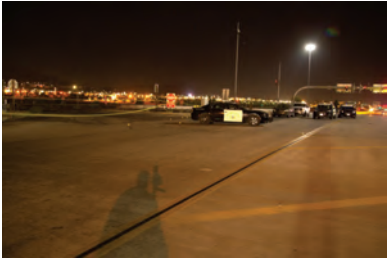
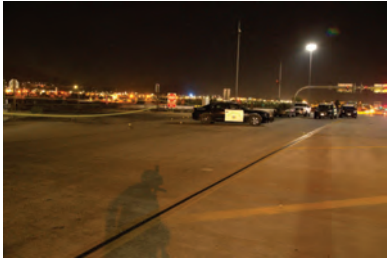



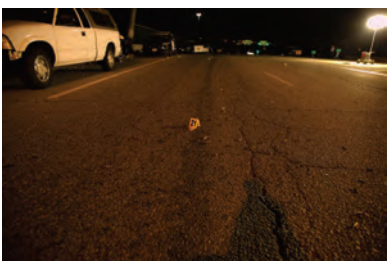





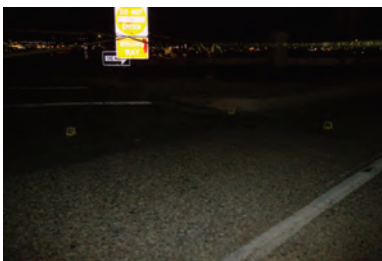

190073/09
8/20/19
OIS/107A RPD
L-VEIN#1723

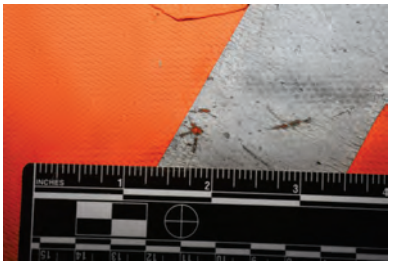
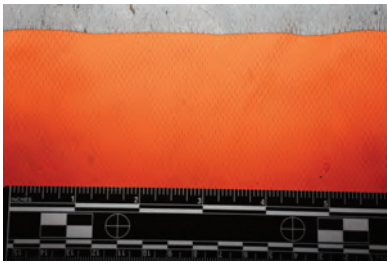
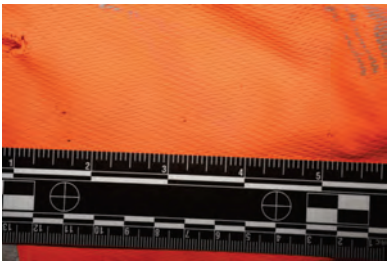
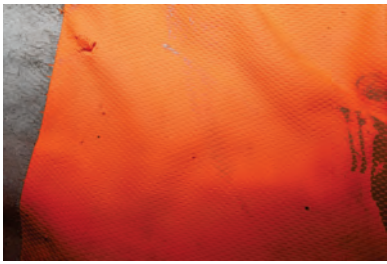
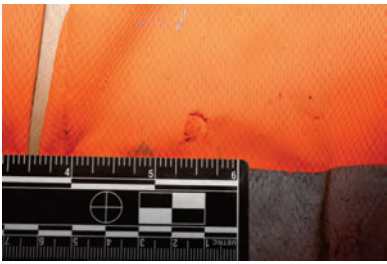

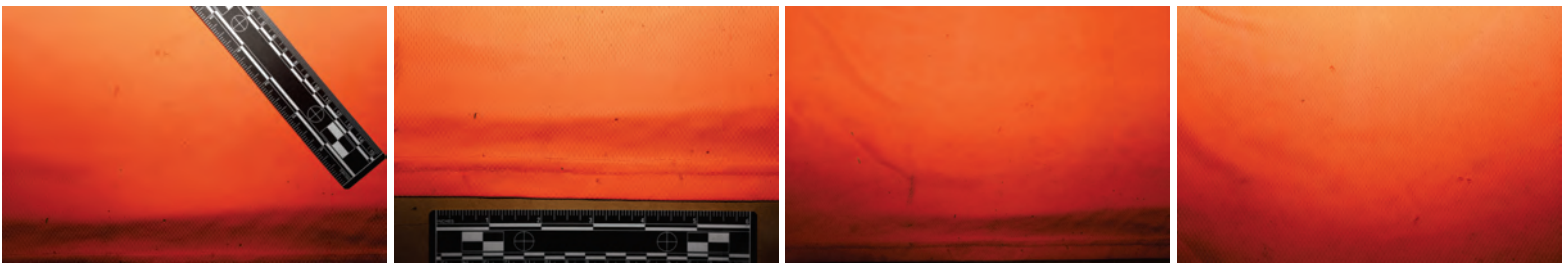
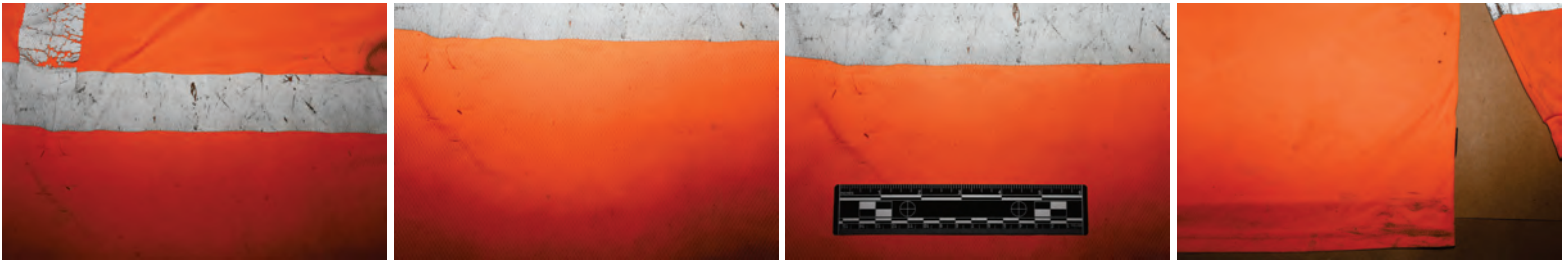

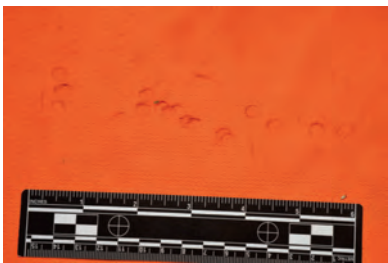
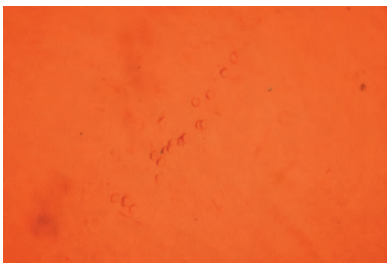
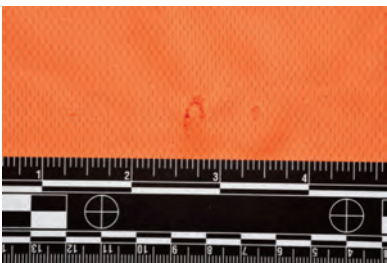
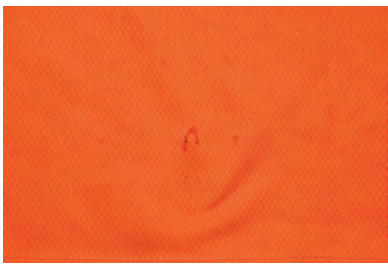
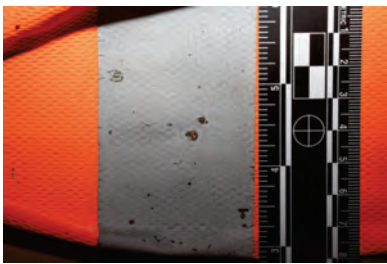
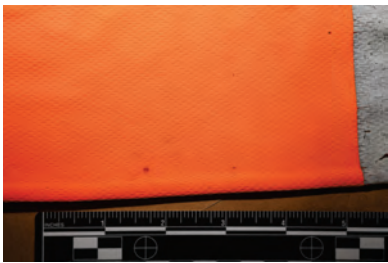
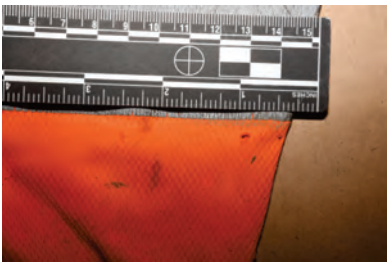

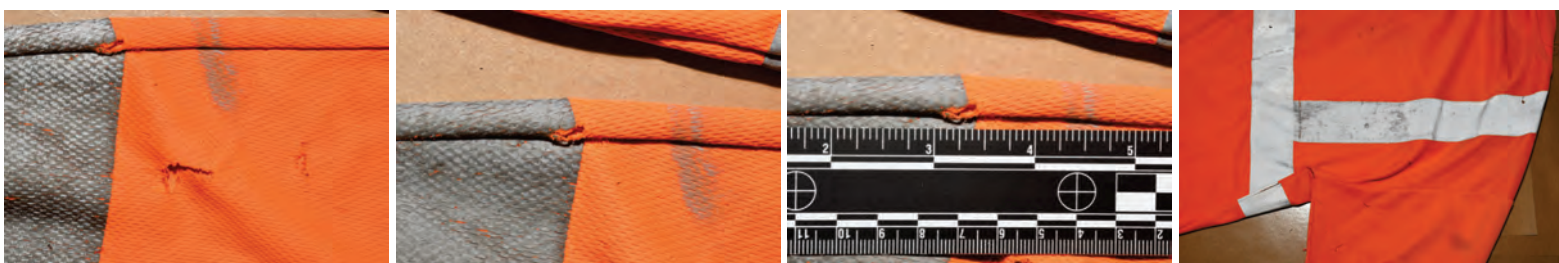
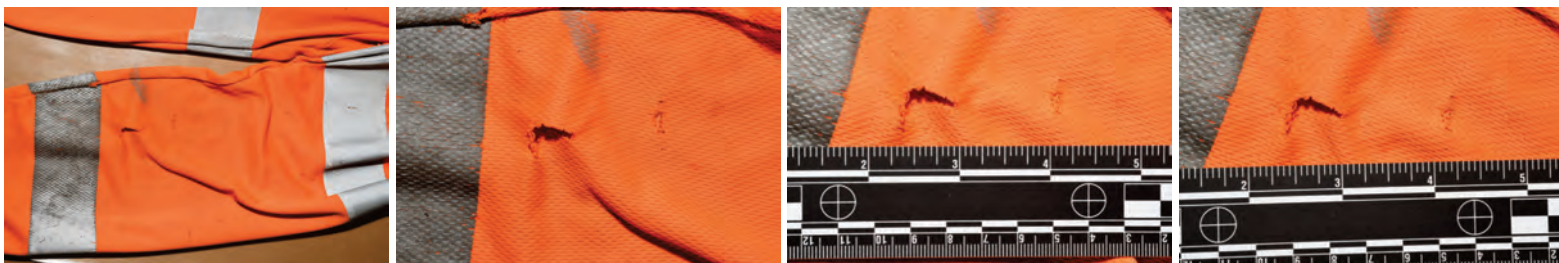

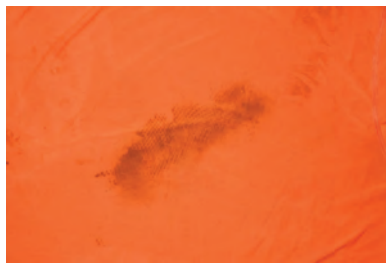
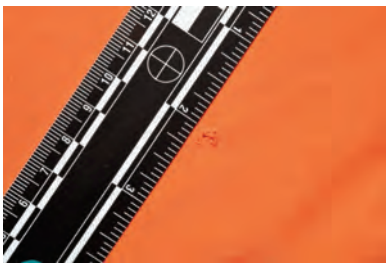
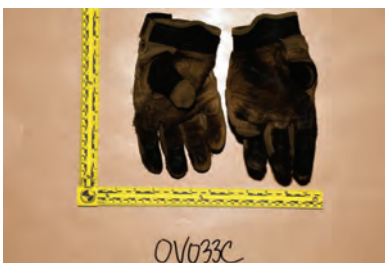

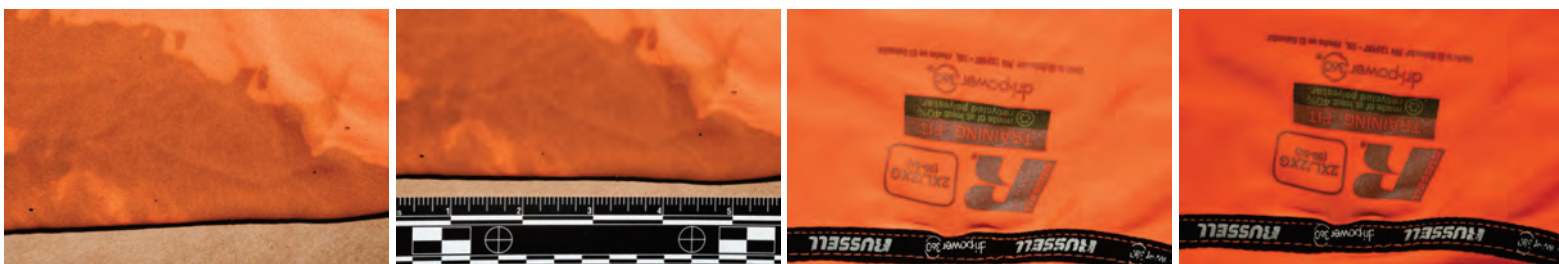
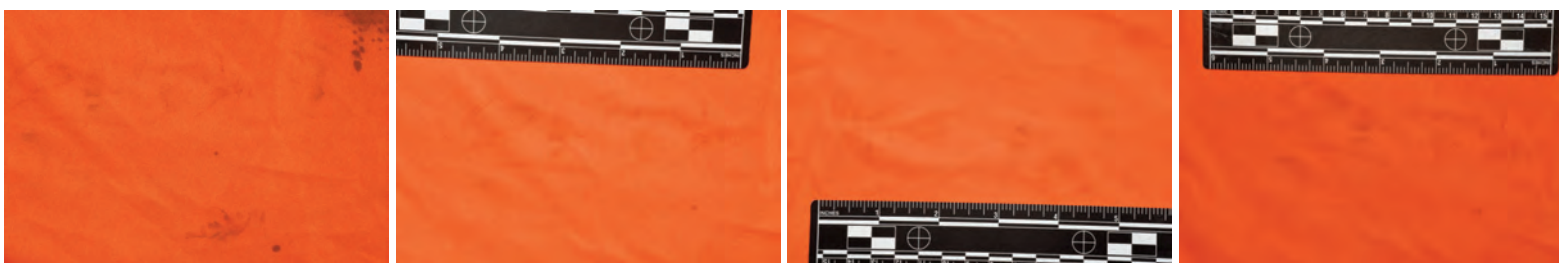

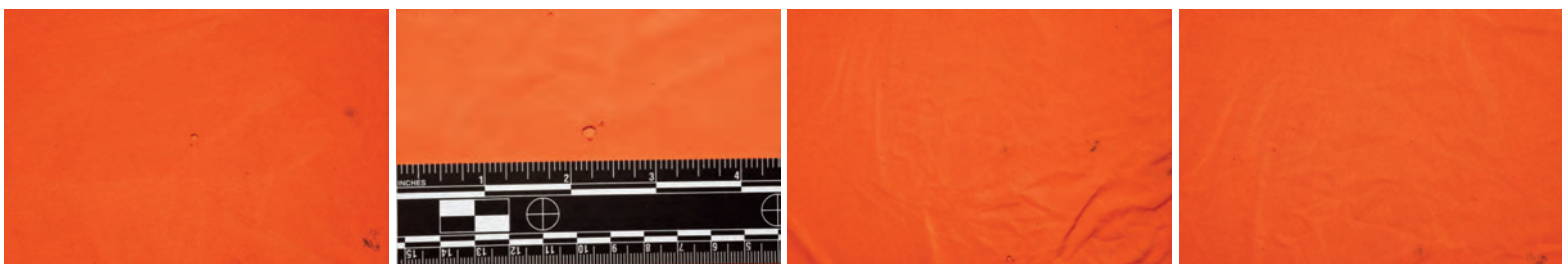
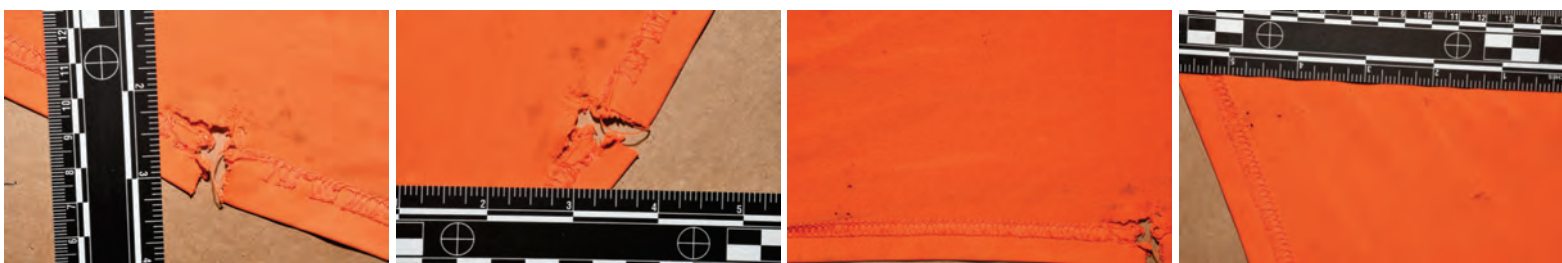

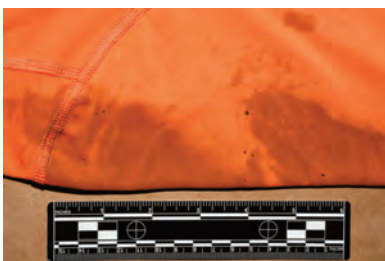
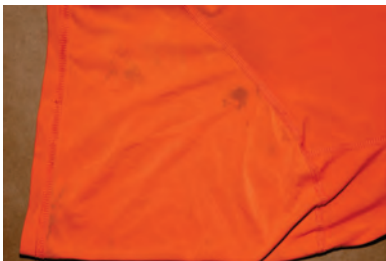

DATE / TIME	08-15-19
AGENCY	R.P.D.
CASE #	1900A3/09
PHOTOGRAPHED BY	D. BOGGS-FATTEN
[Color calibration chart]	





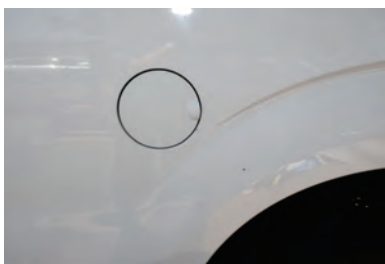
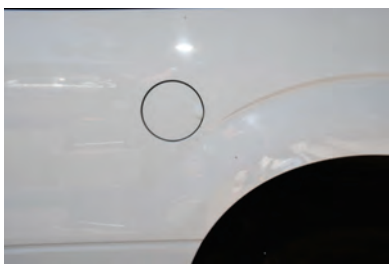

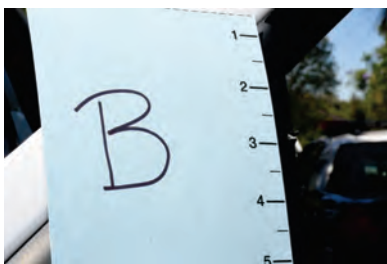
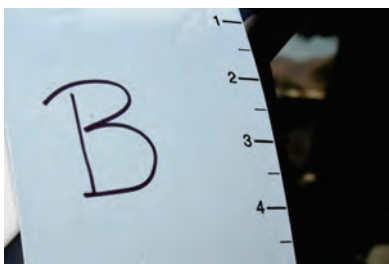
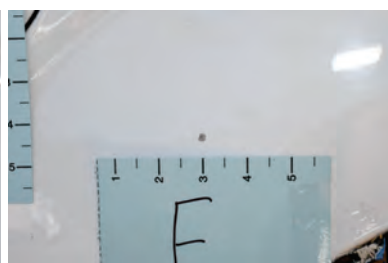
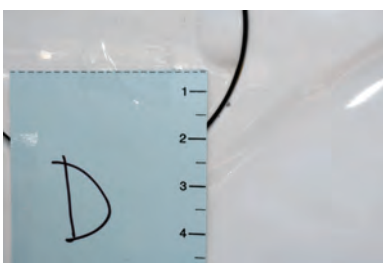
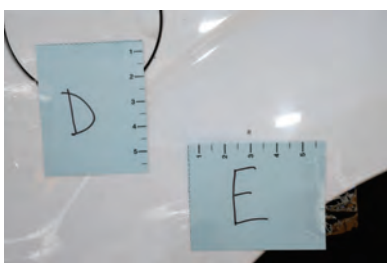
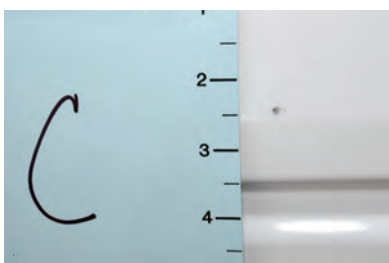
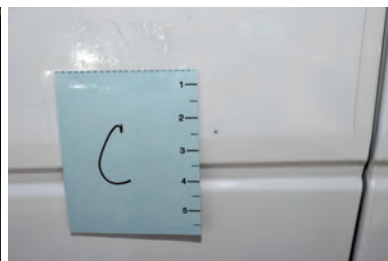
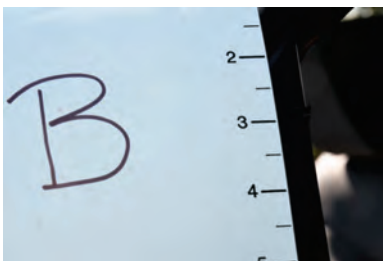
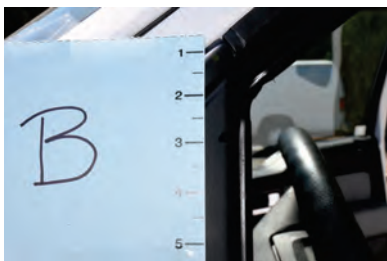

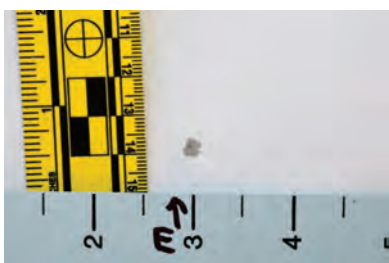
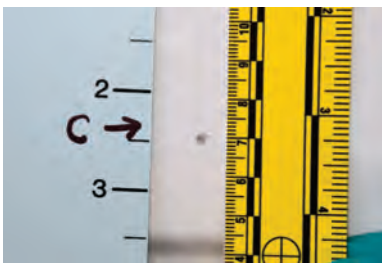

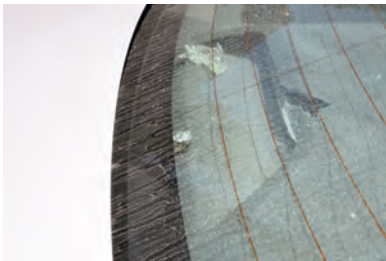
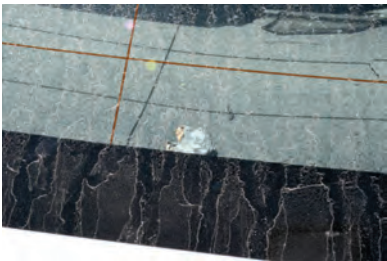
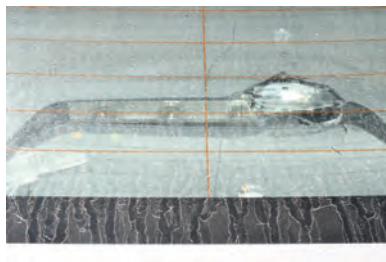
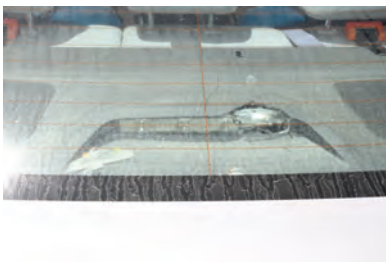





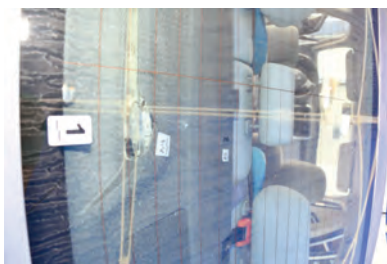

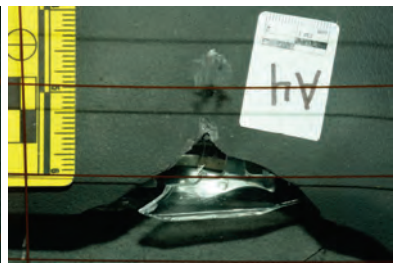
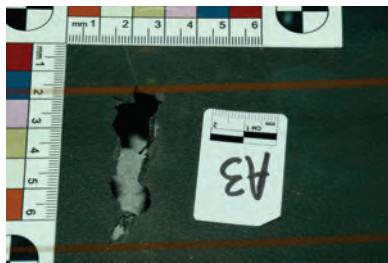
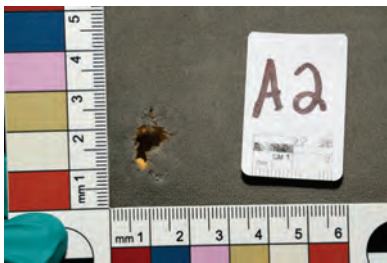
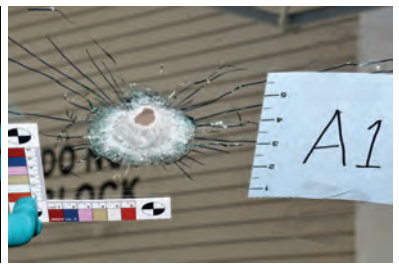
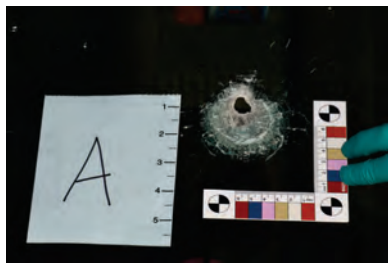
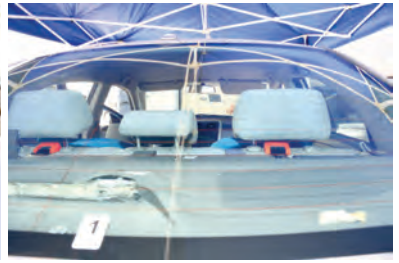
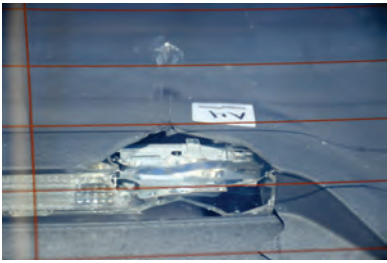

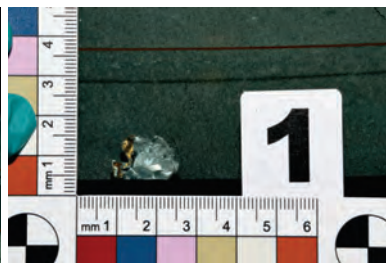
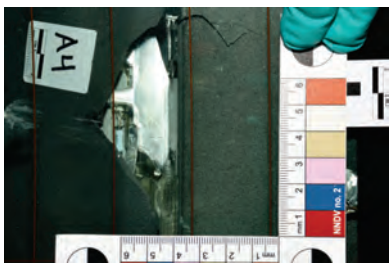

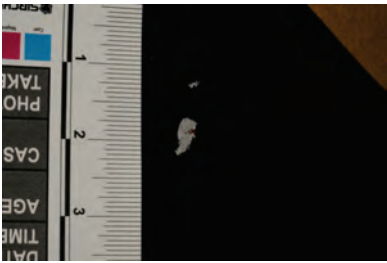
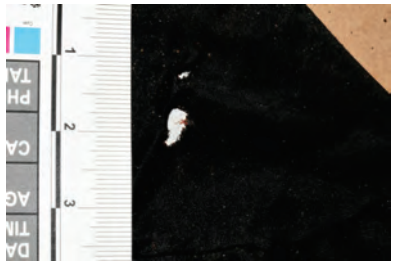
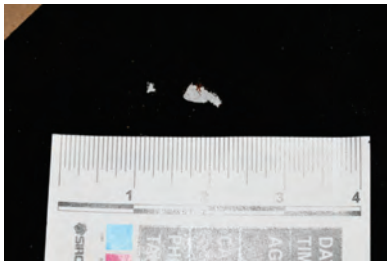
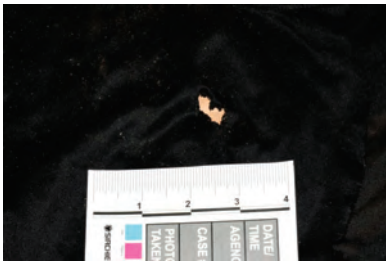
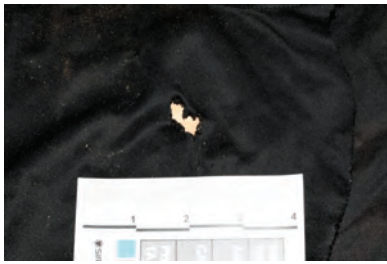

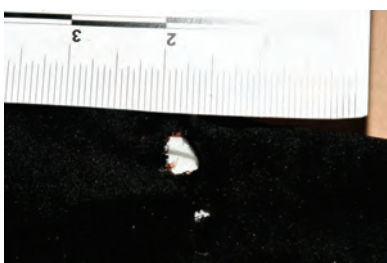
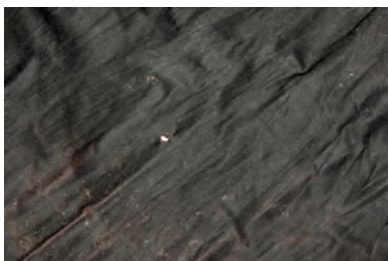

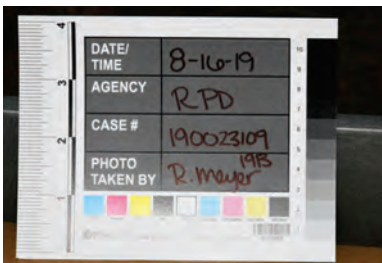



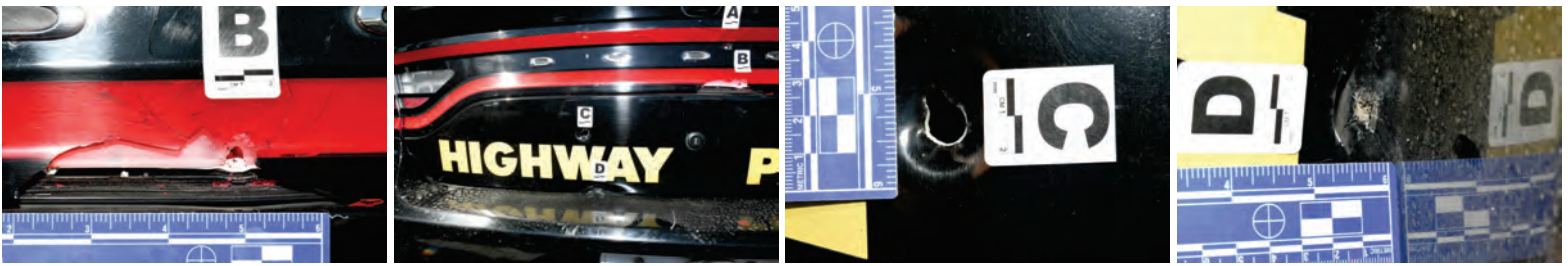

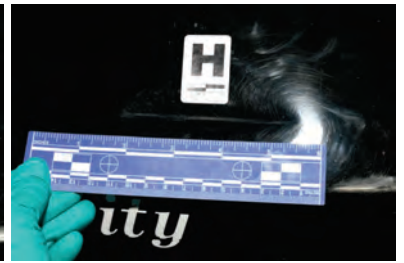
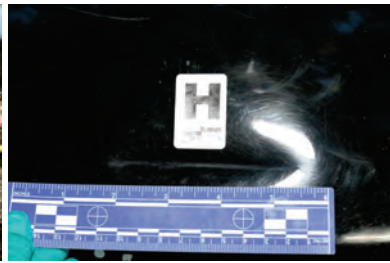
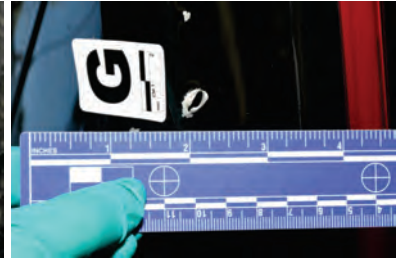
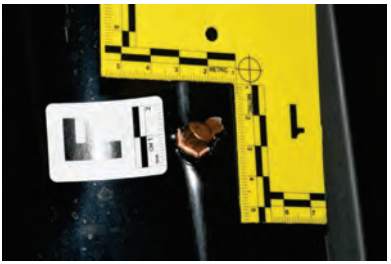
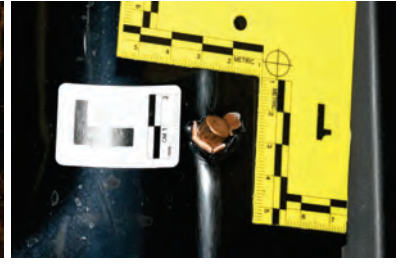
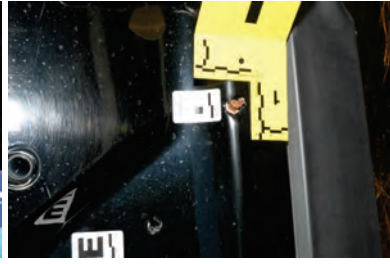
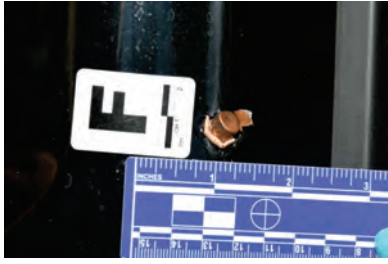
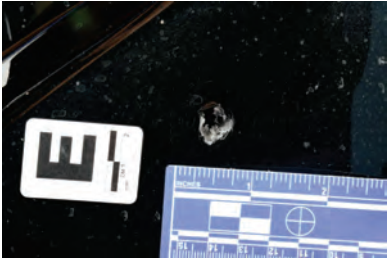

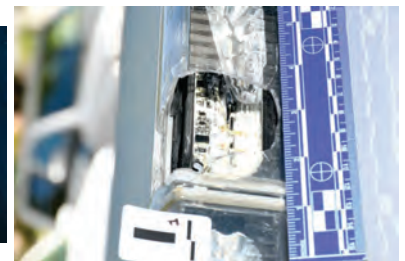
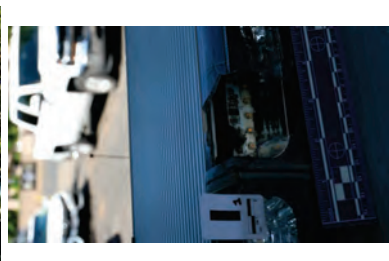
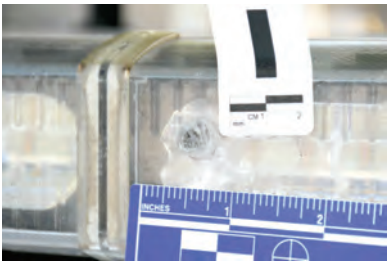
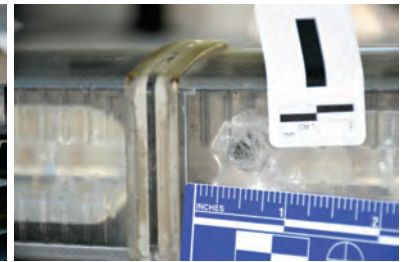

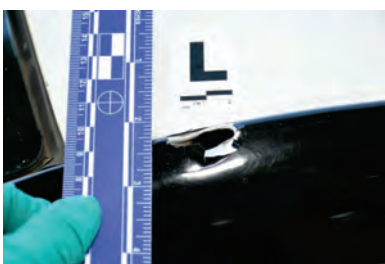
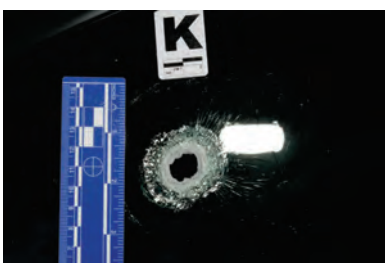
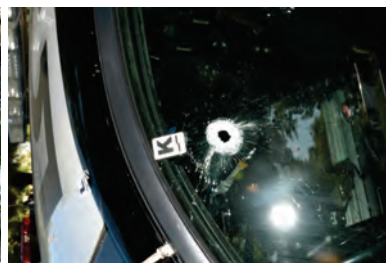
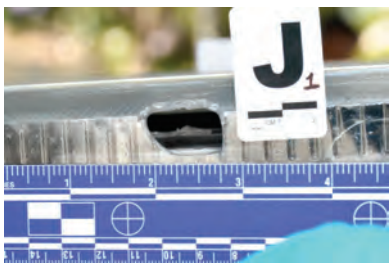

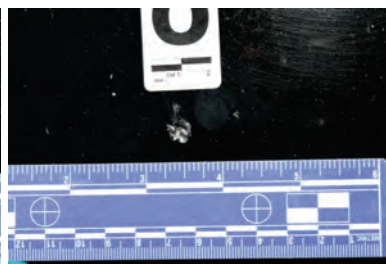
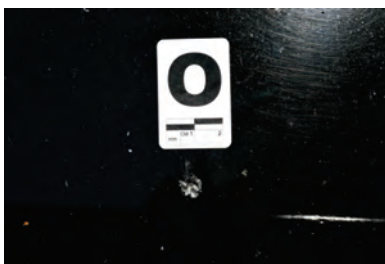

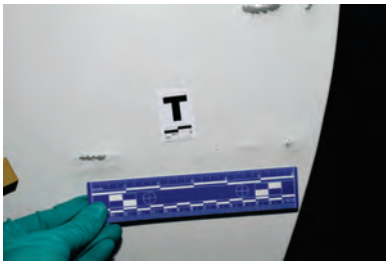
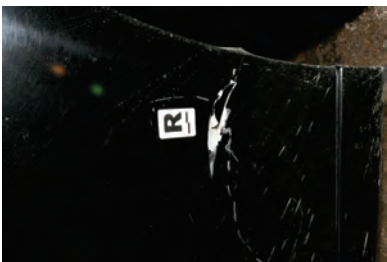

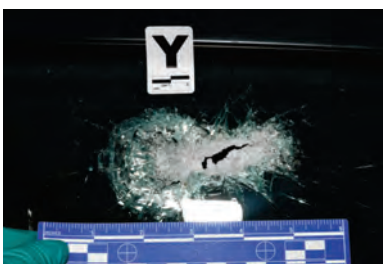
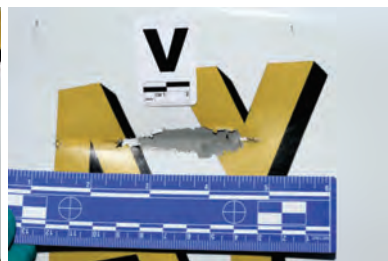

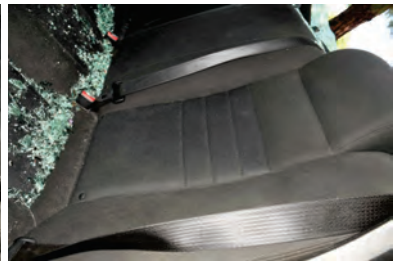



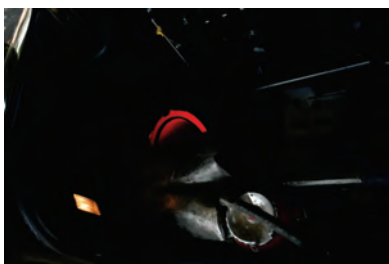



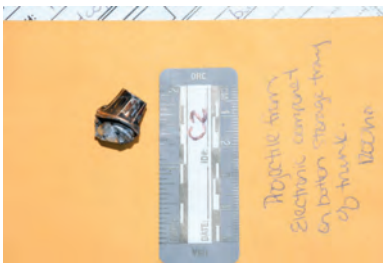
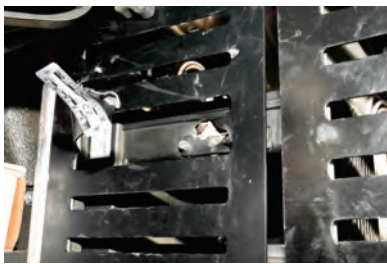
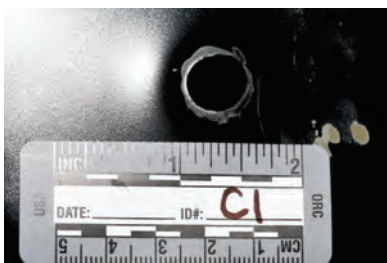
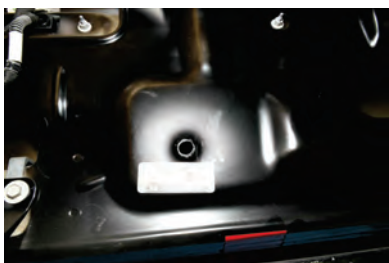
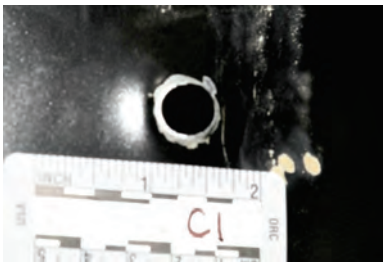

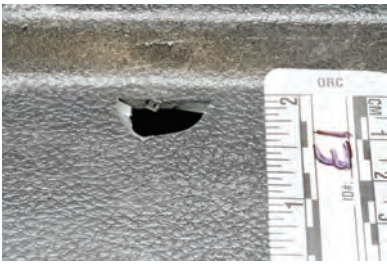
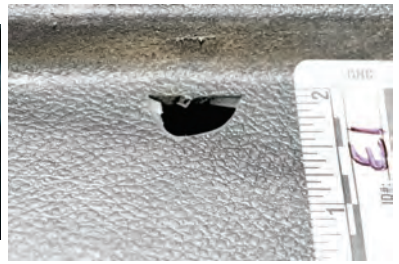
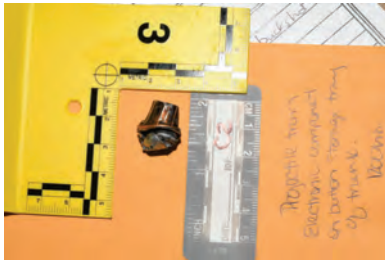

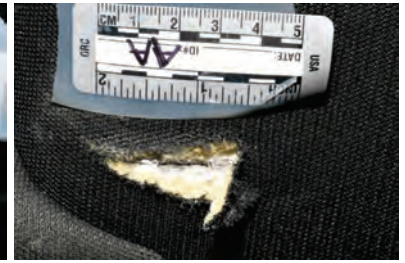
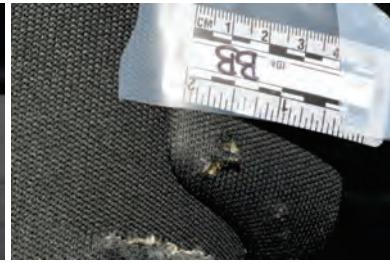
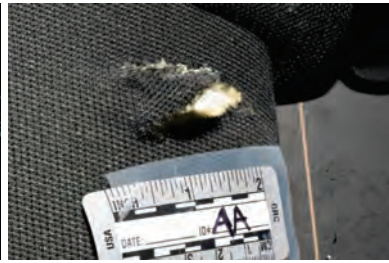

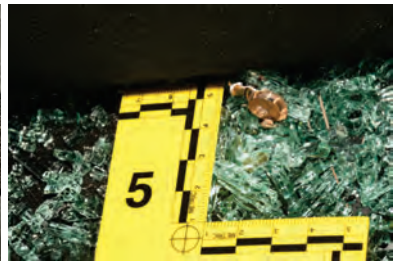
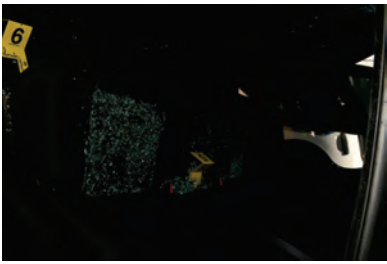
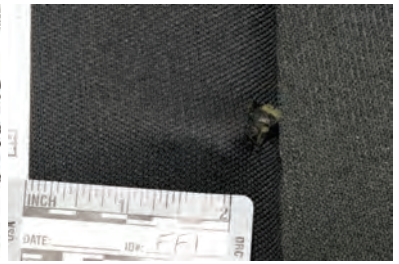
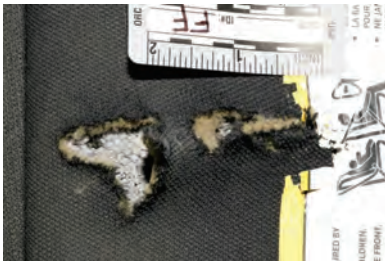

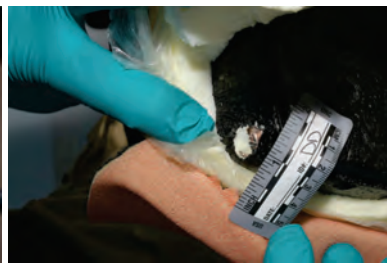
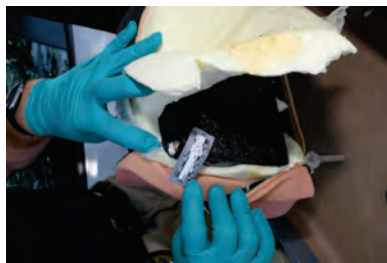
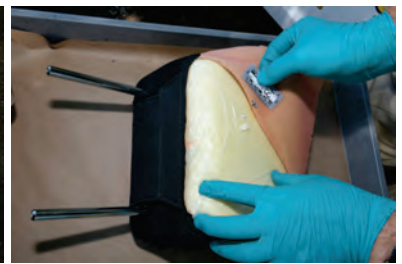
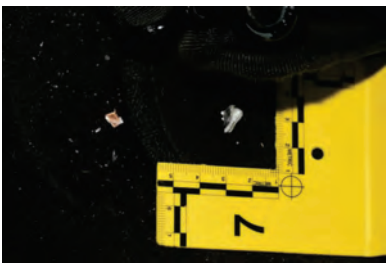

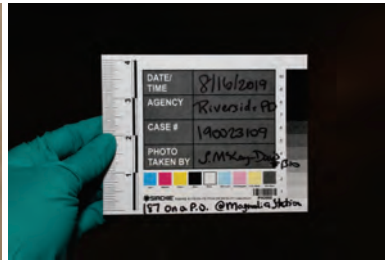



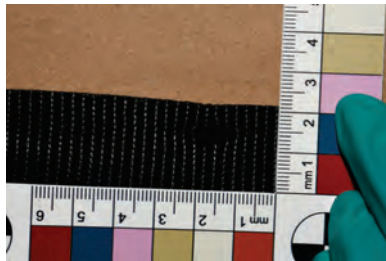
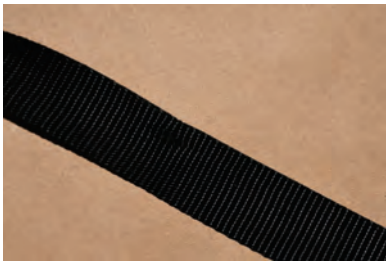
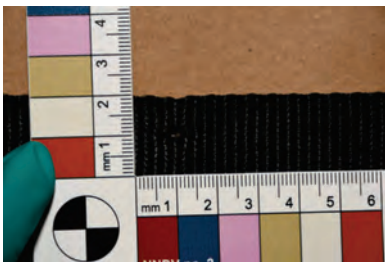
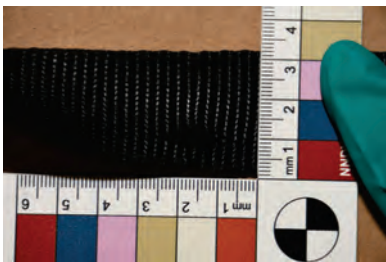

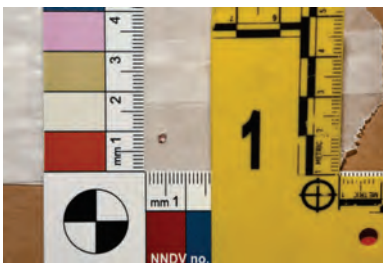
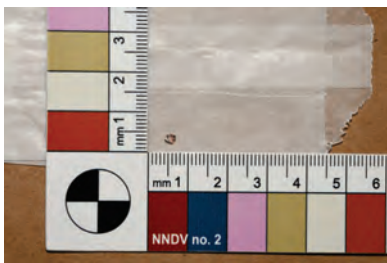
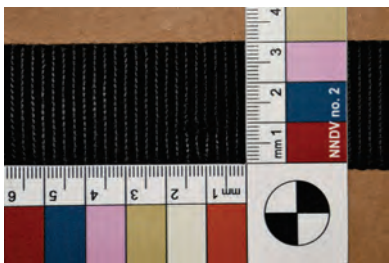



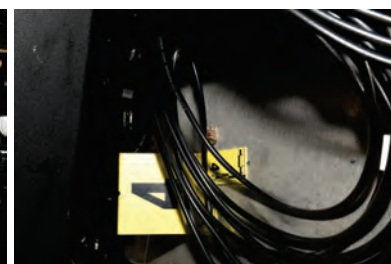
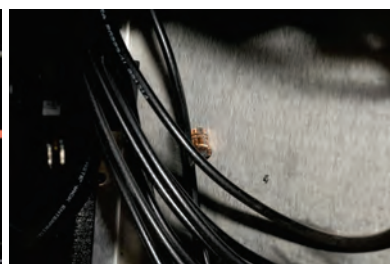

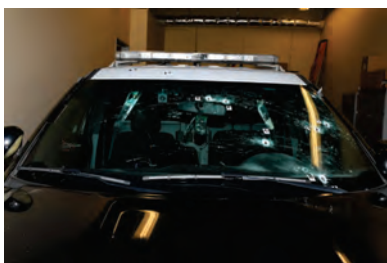
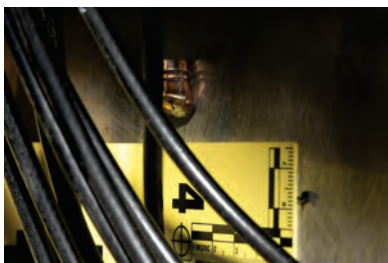

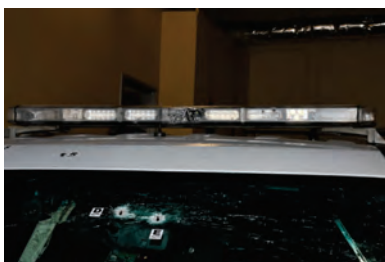
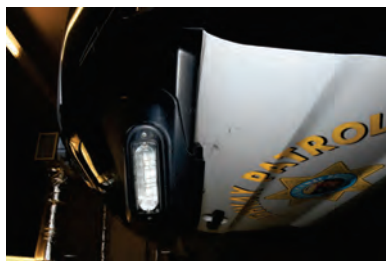

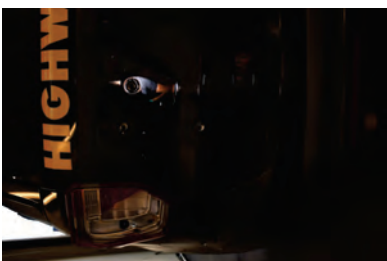

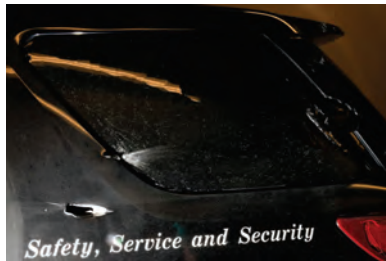
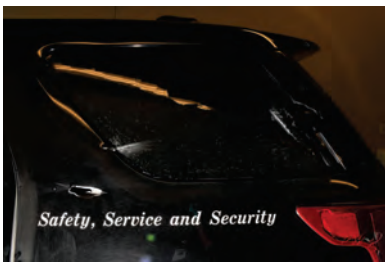
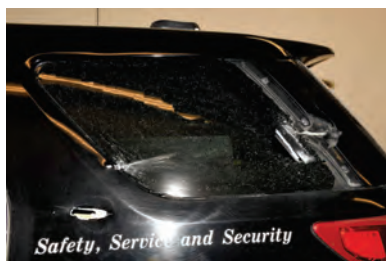
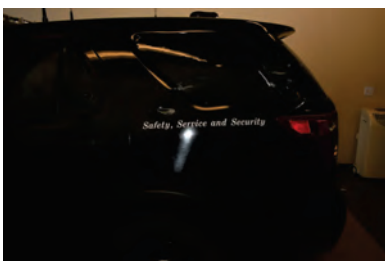

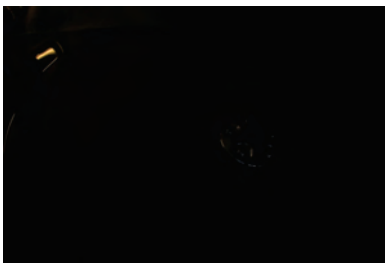
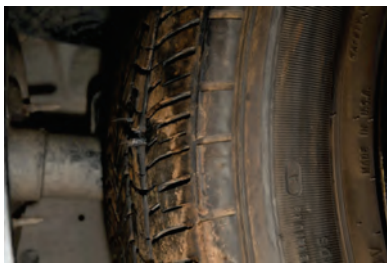
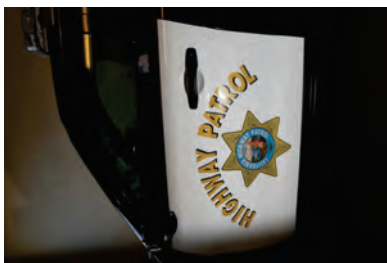

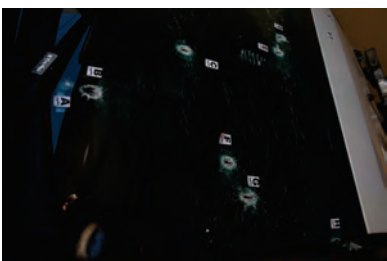
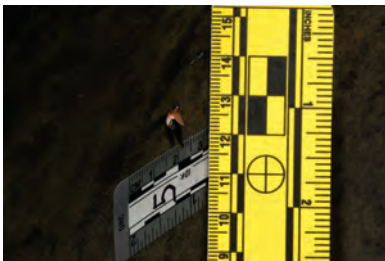

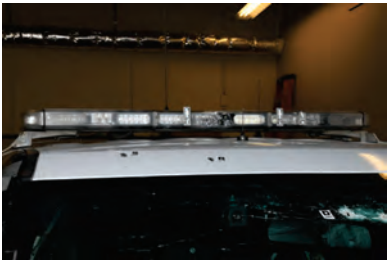

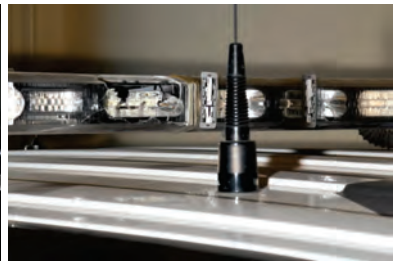
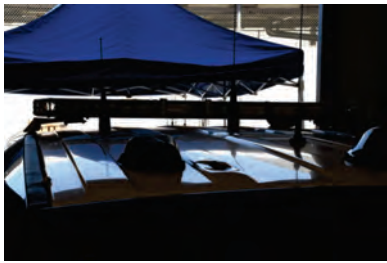

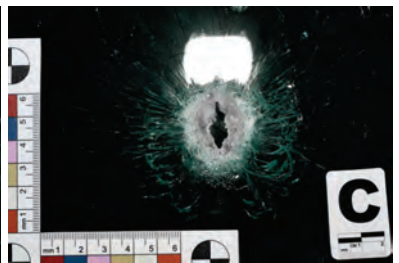
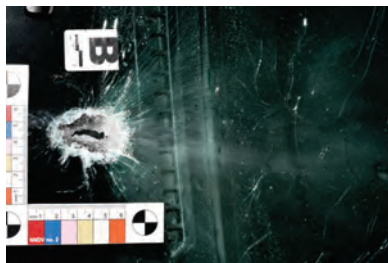
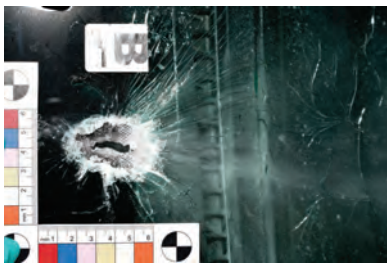
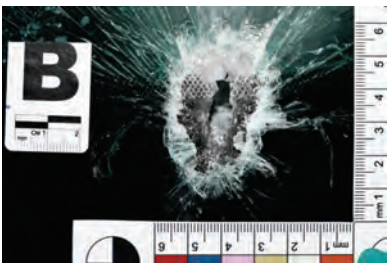
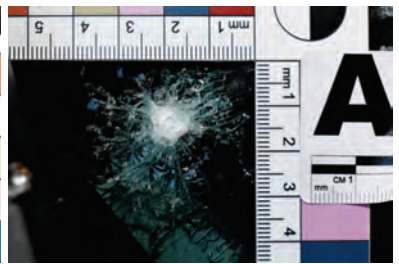
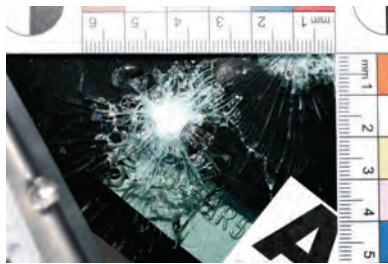
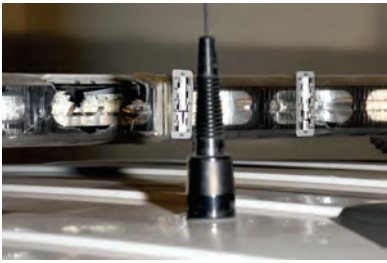

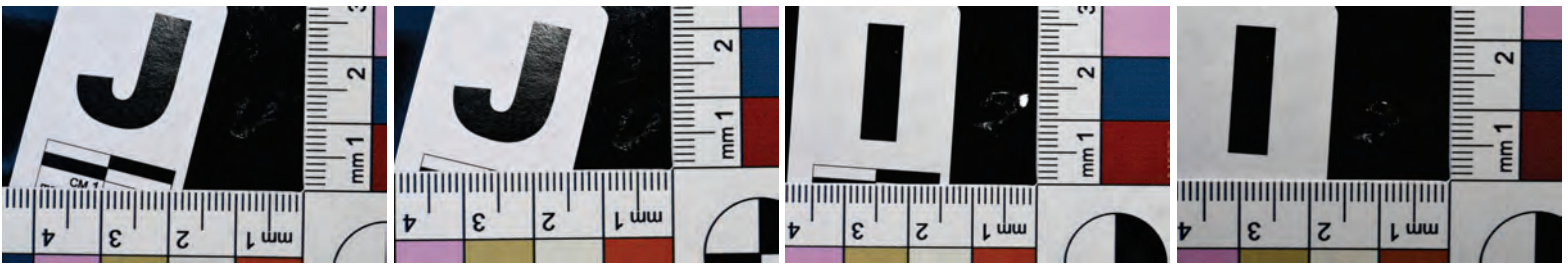
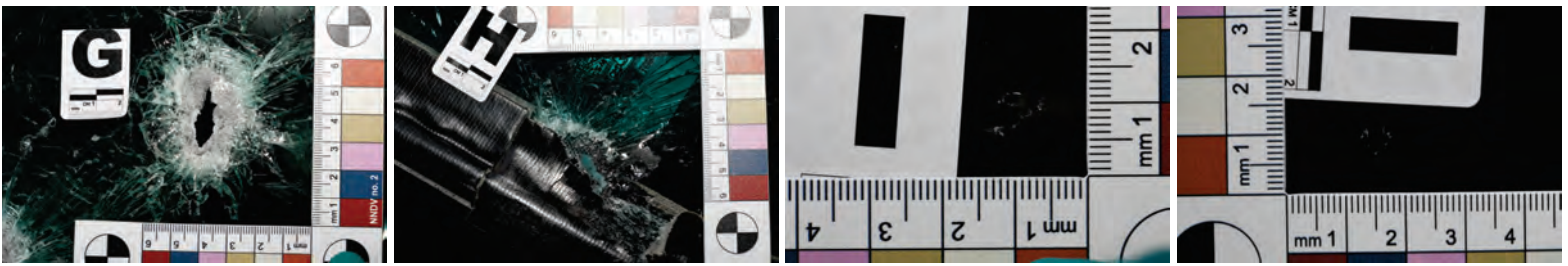
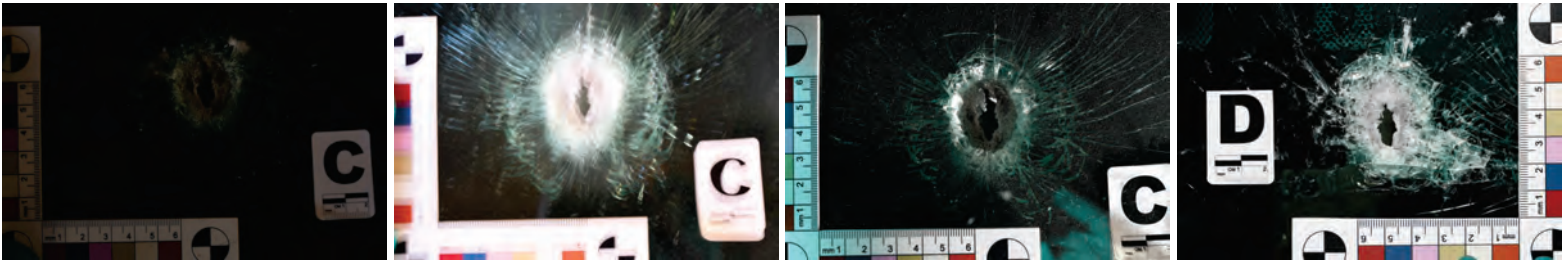

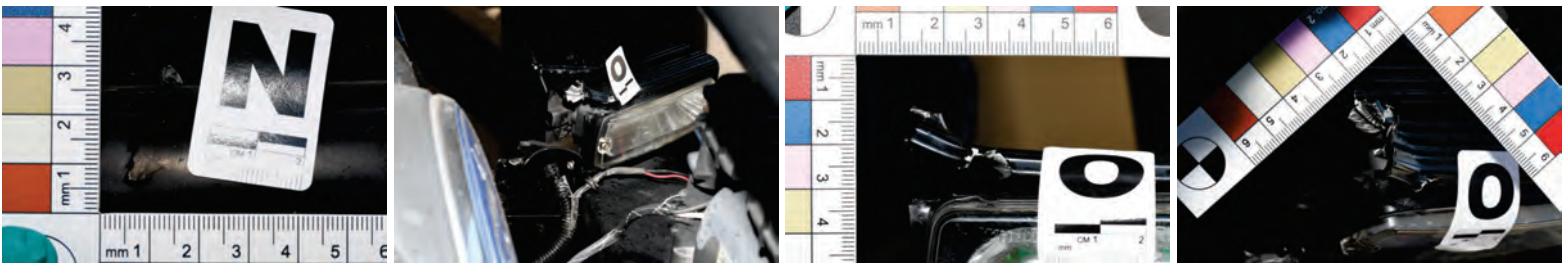
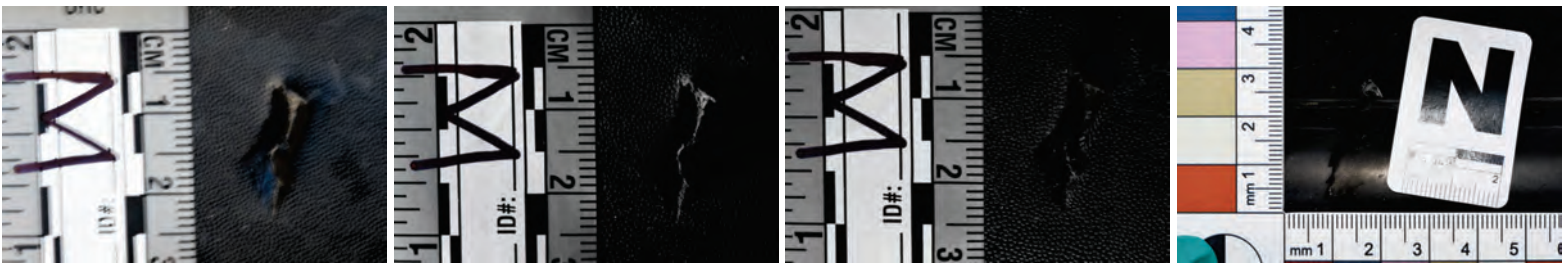
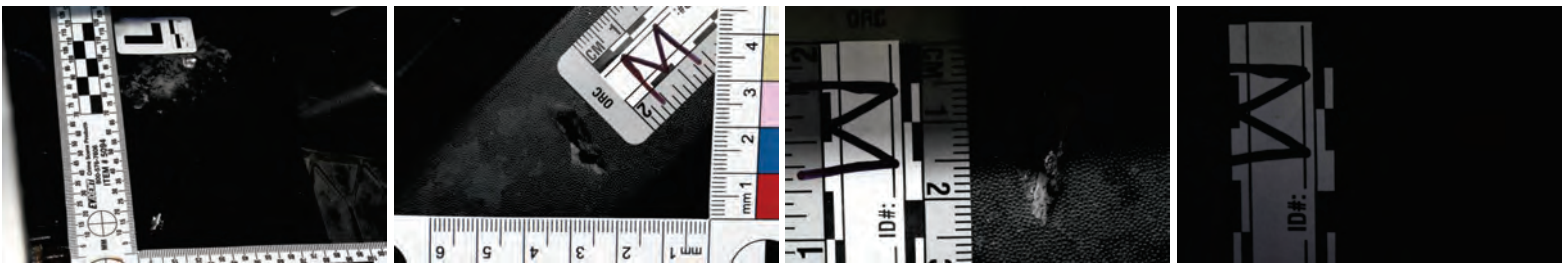
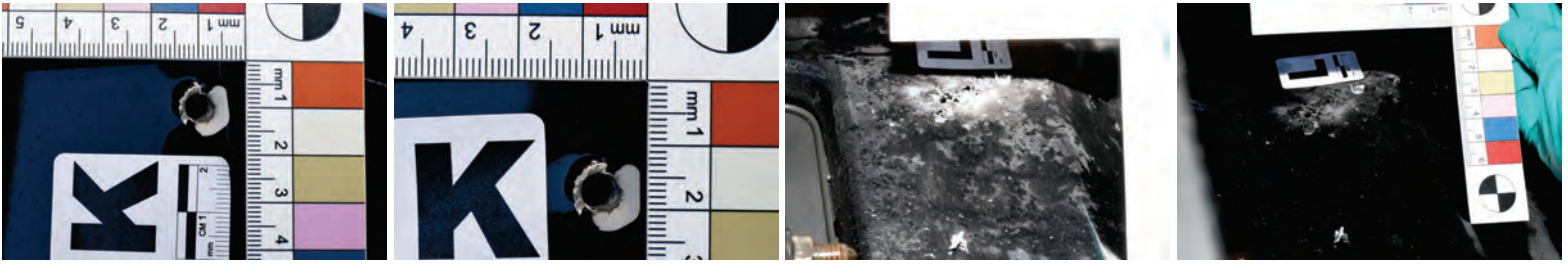



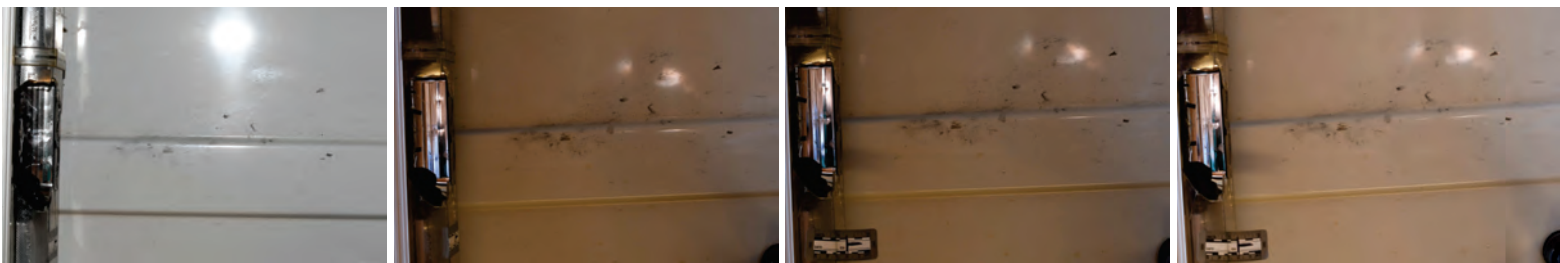

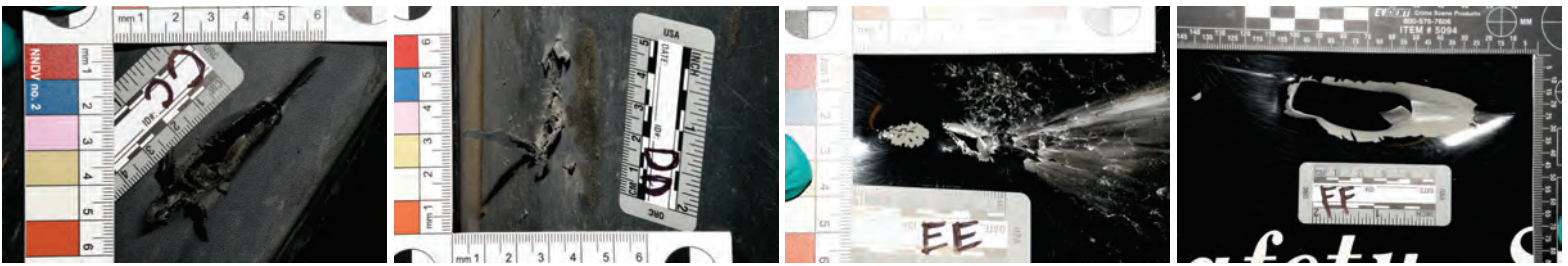
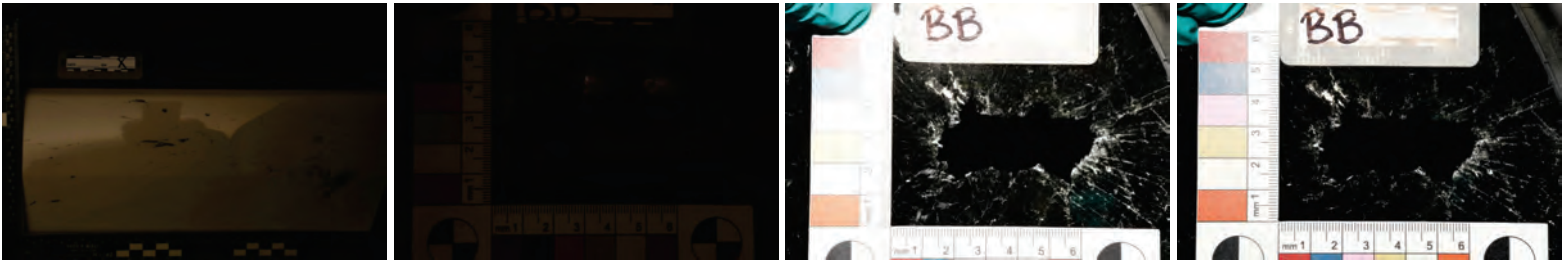

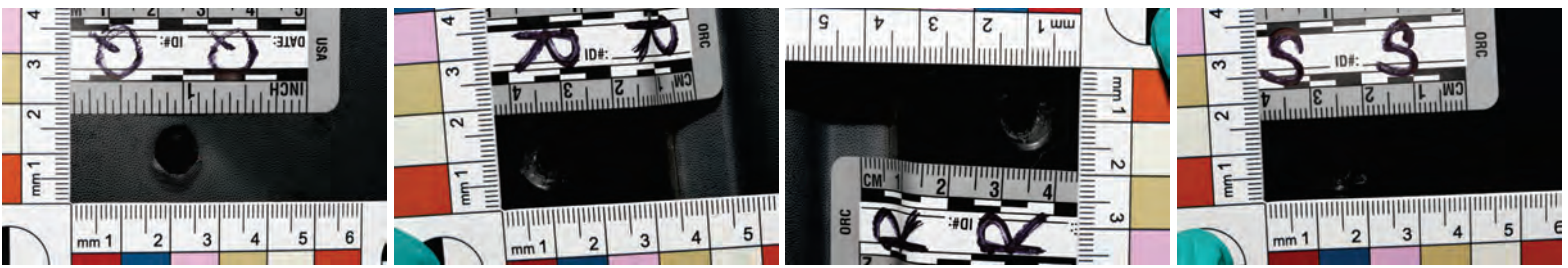
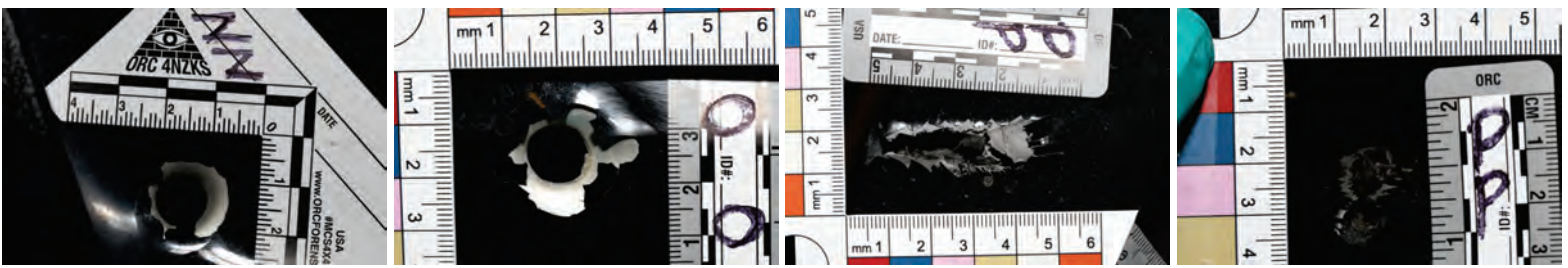
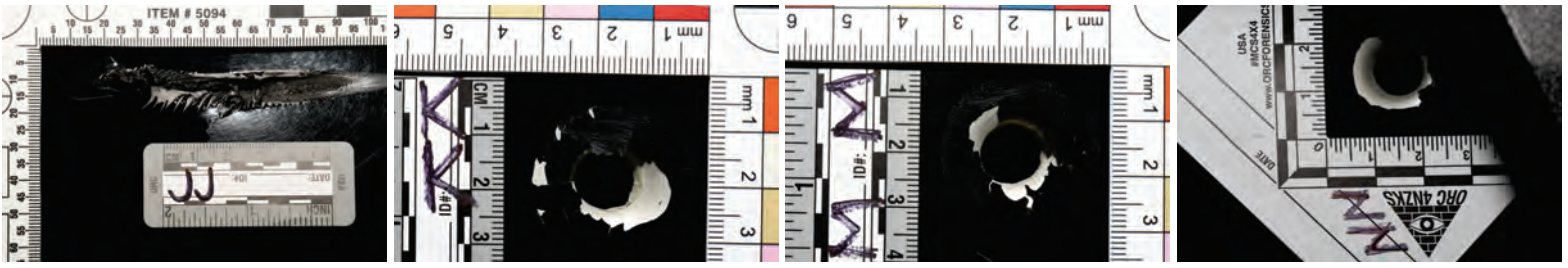

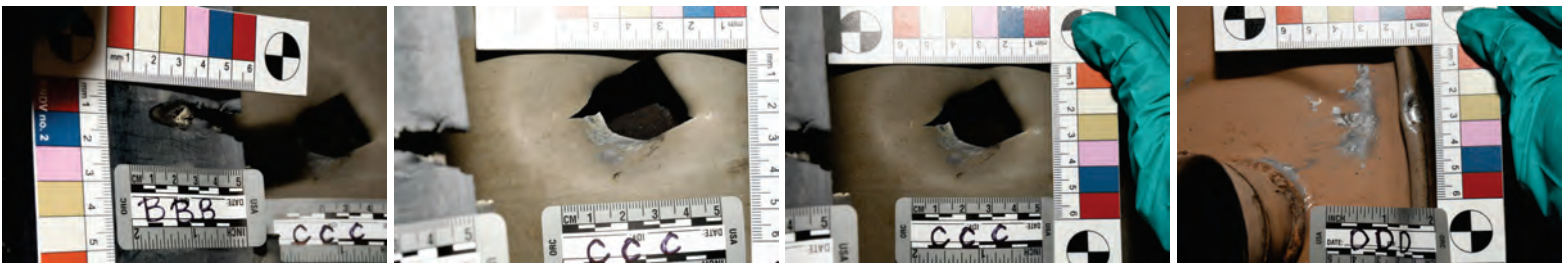
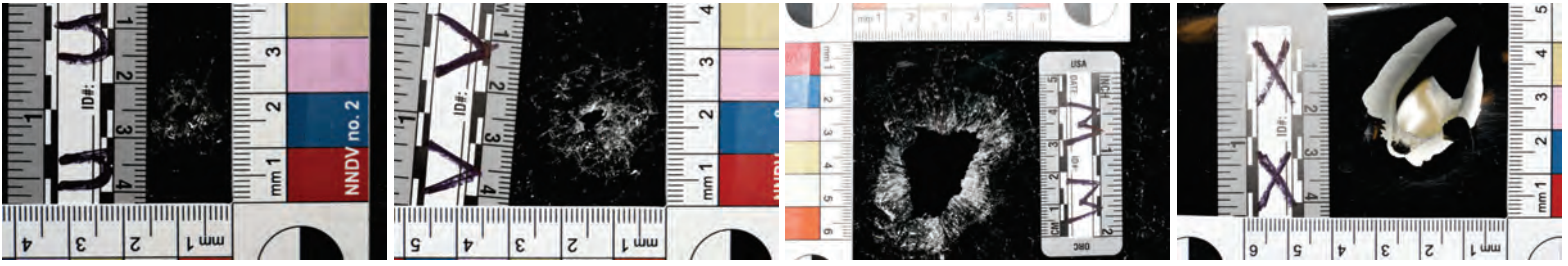

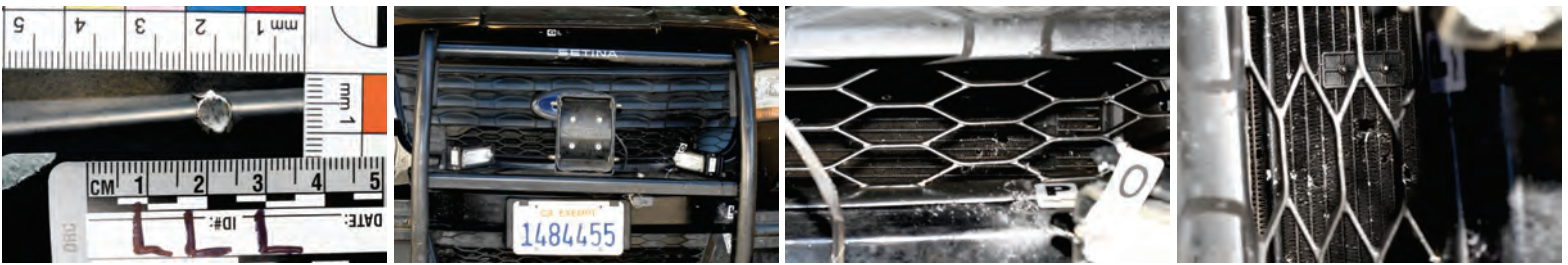
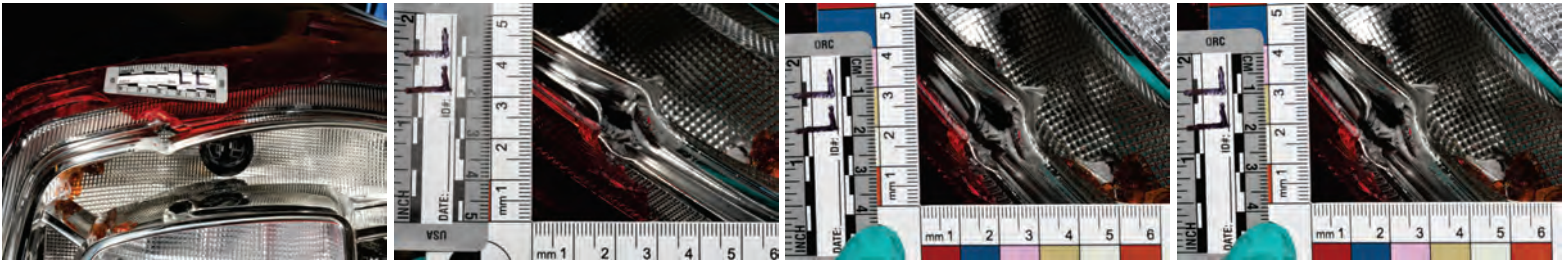

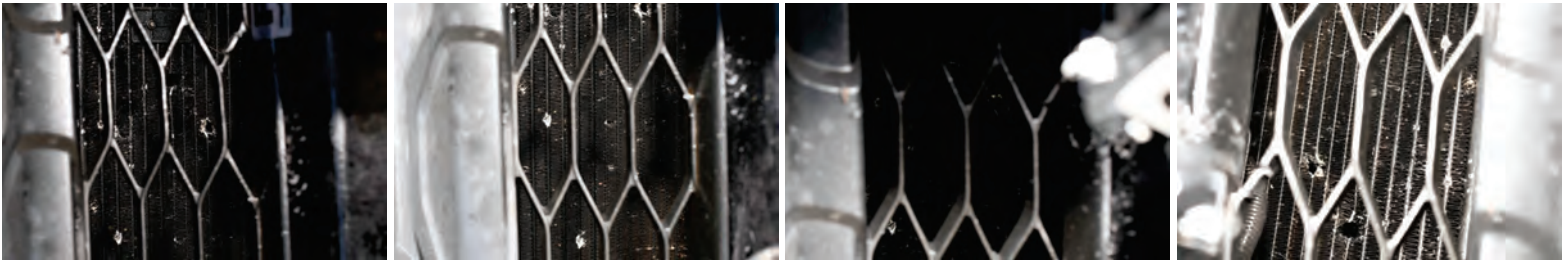



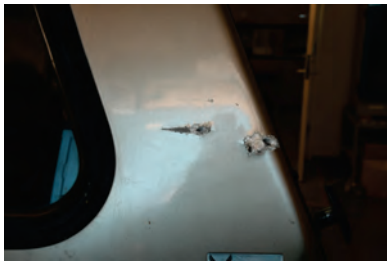



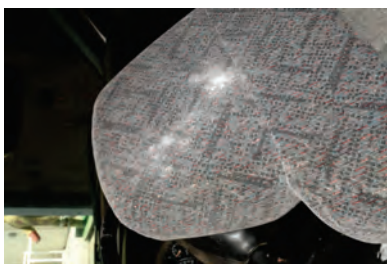
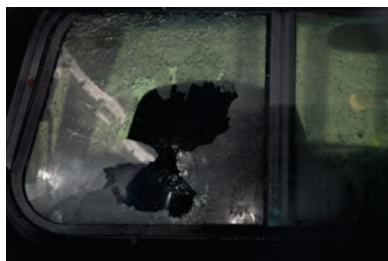
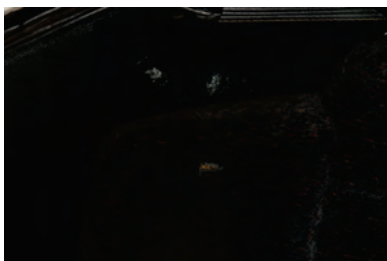
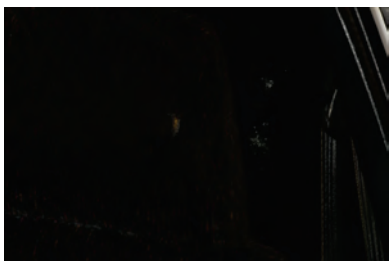

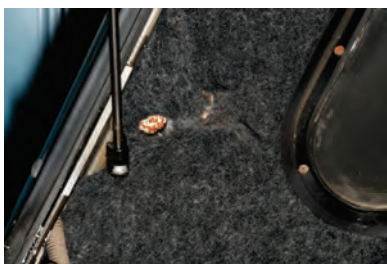

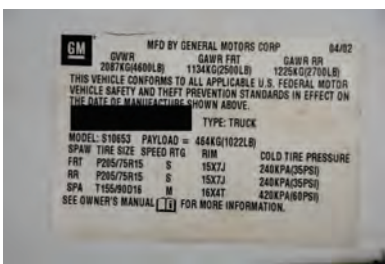





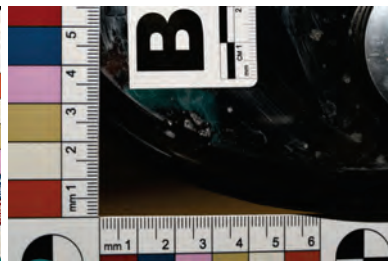
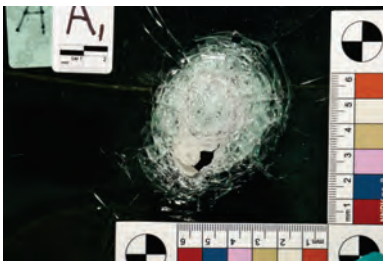
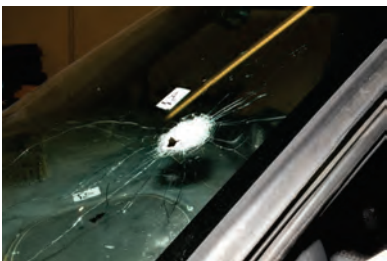
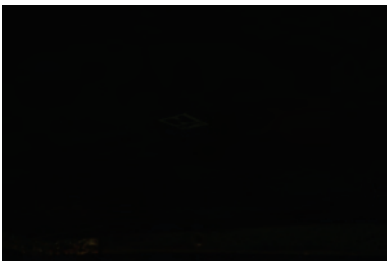

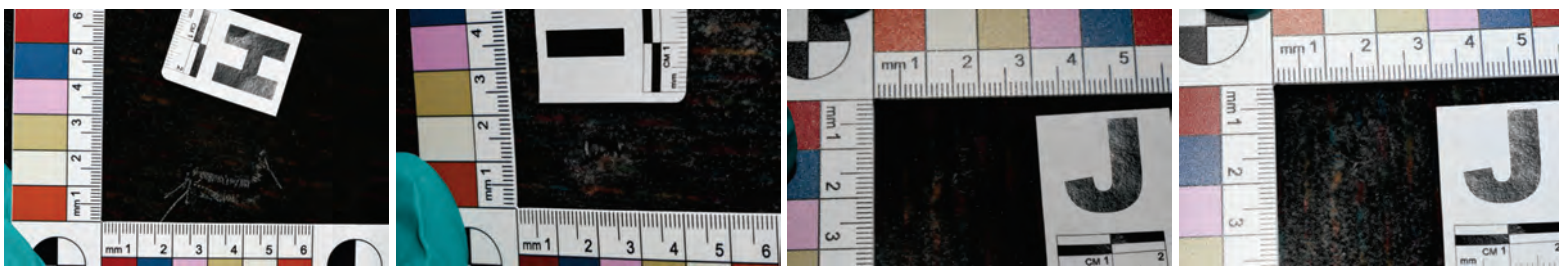
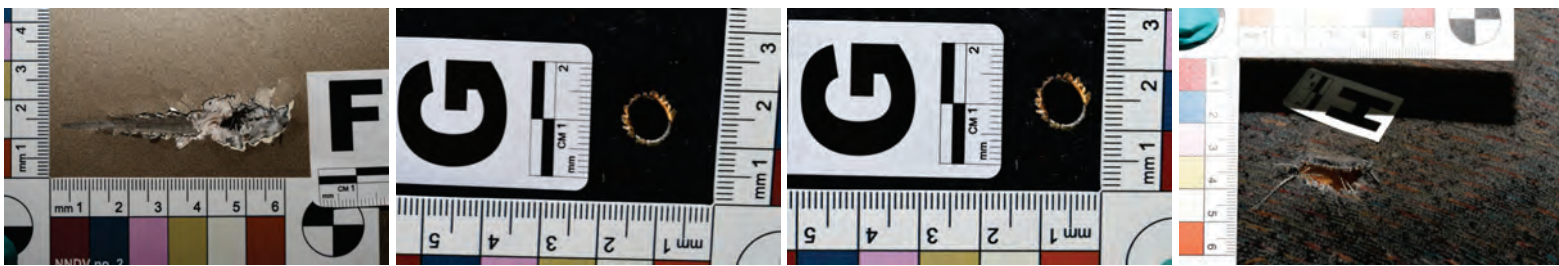

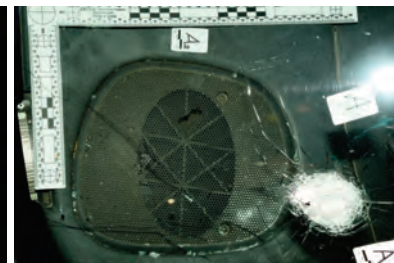
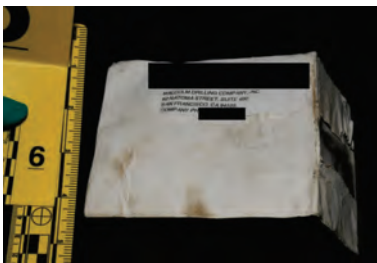
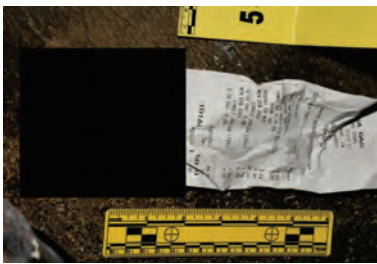
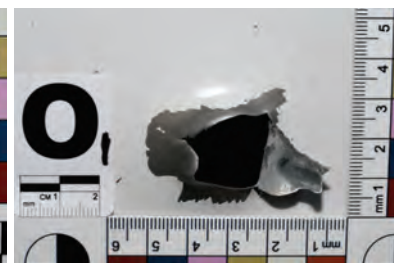
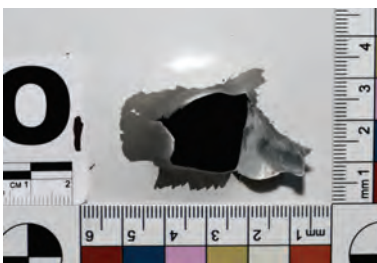
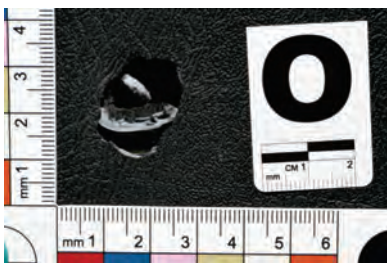
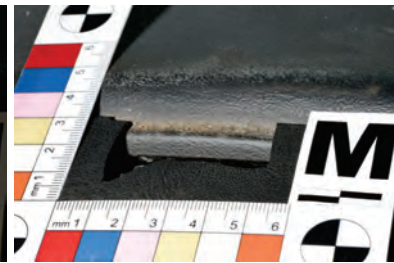
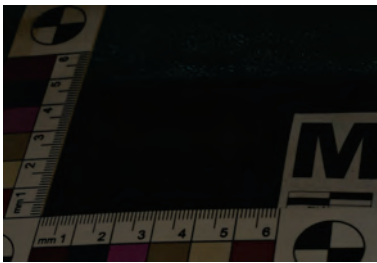
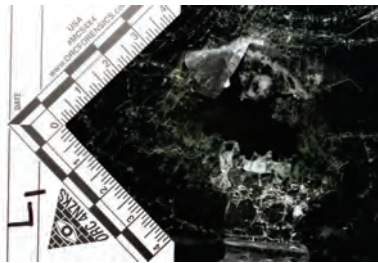
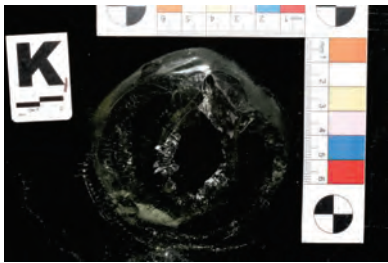

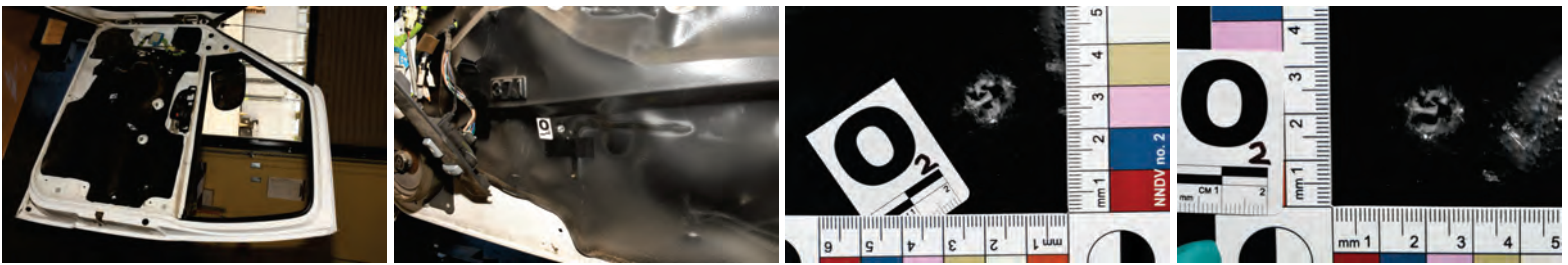
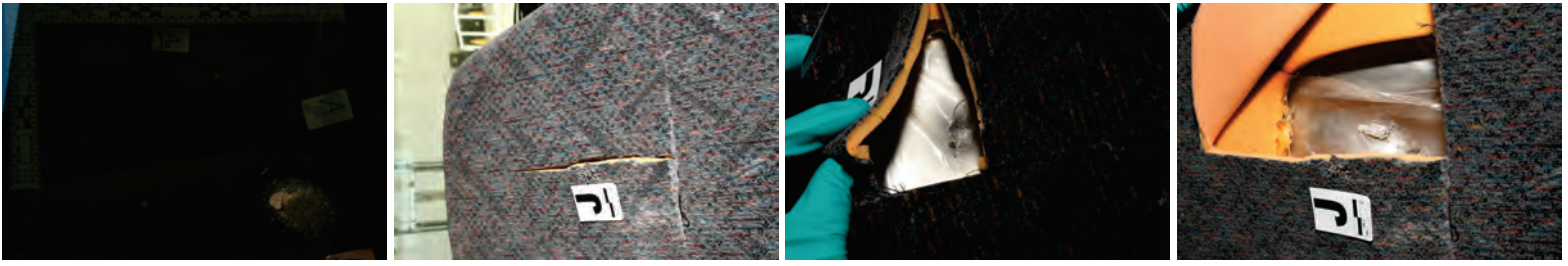

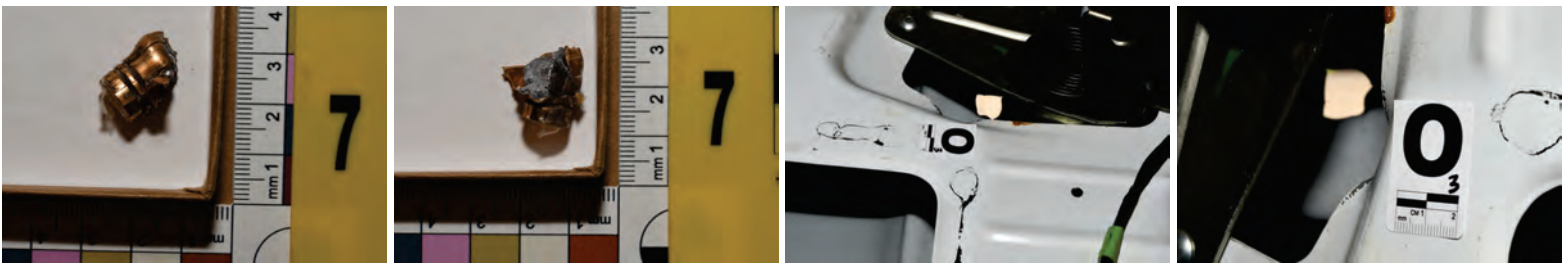
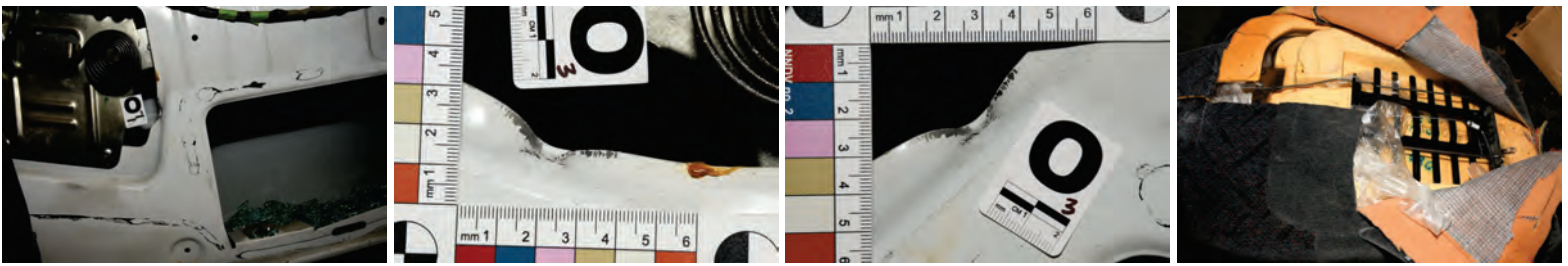

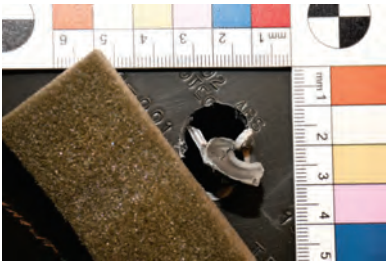
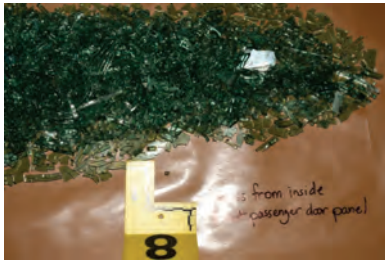

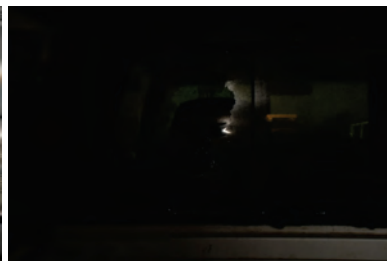
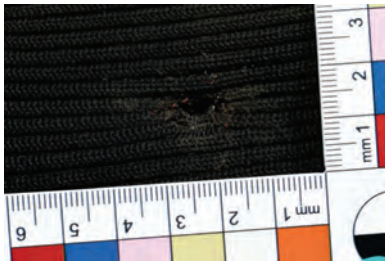
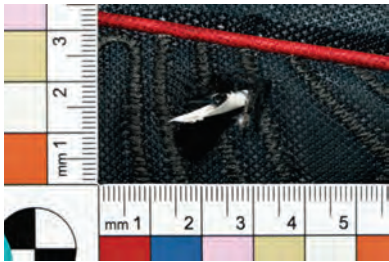

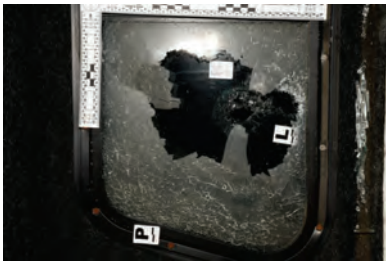
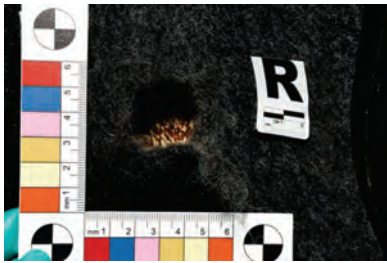
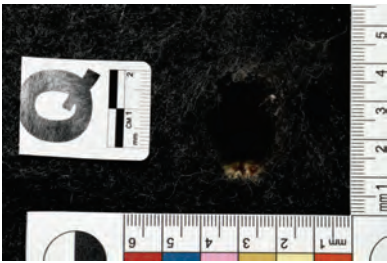
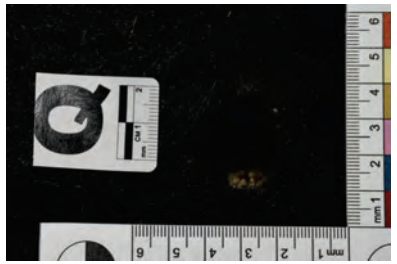
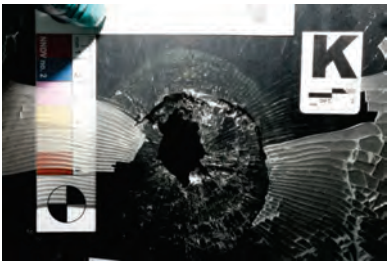

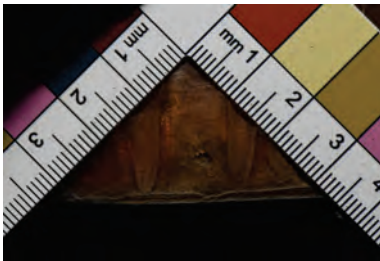
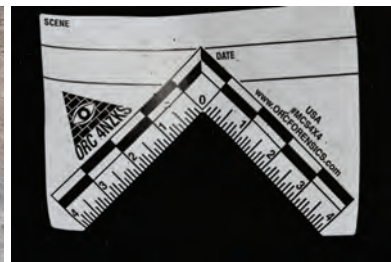
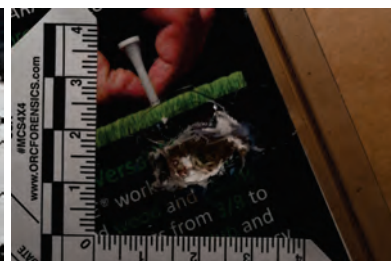

DATE	8/20/19
AGENCY	Riverside PD
DATE #	190023109
PHOTO TAKEN BY	S.M. Kay-Davis
SCENE	137 PC on P.O. Eastridge / 117 feyn



190023104
8/21/19
OFS-1812 RPD
L-KUN #1723





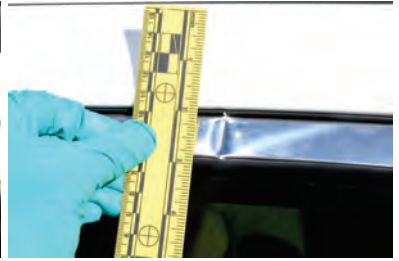
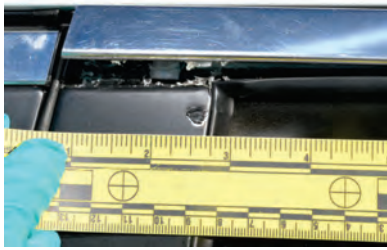
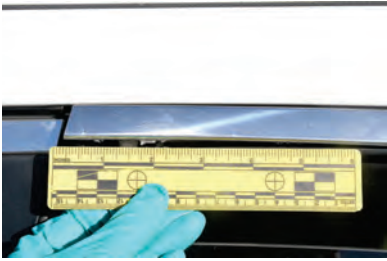

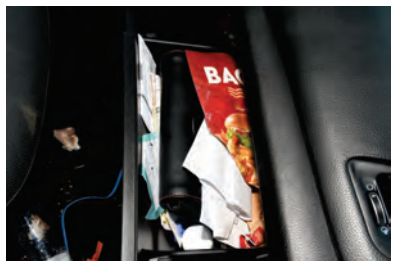
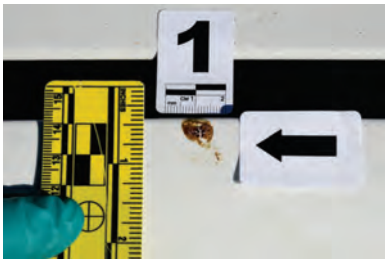
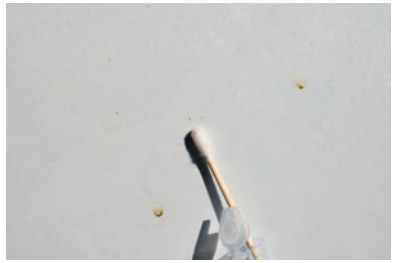



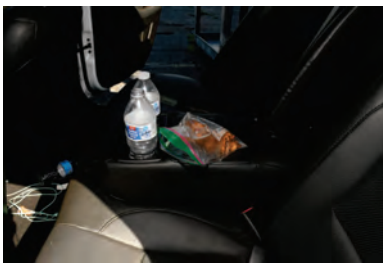
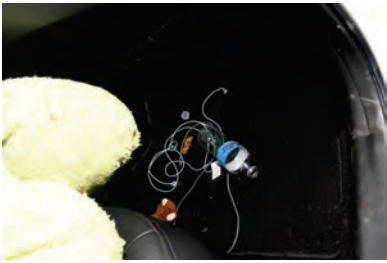



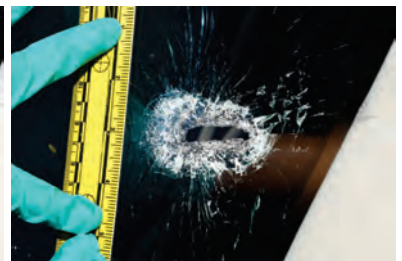
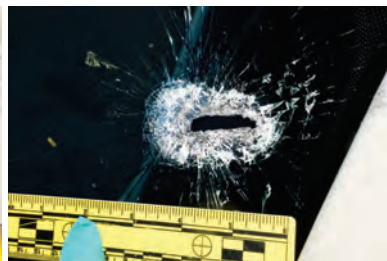
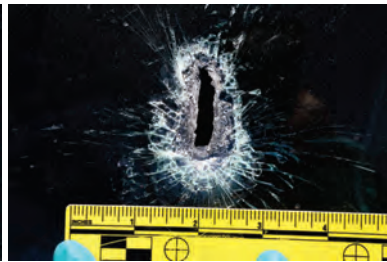
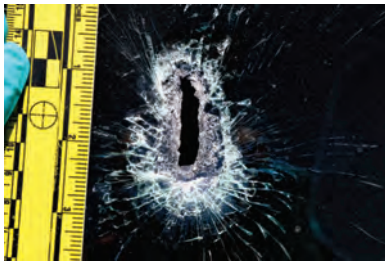

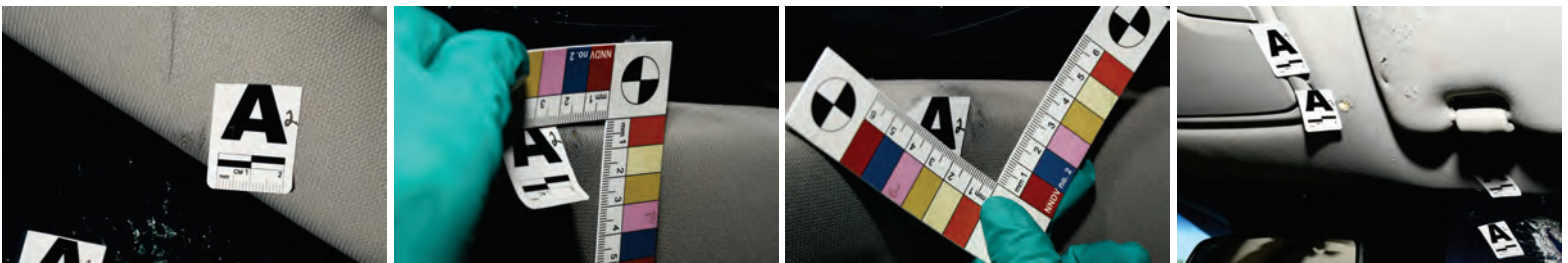
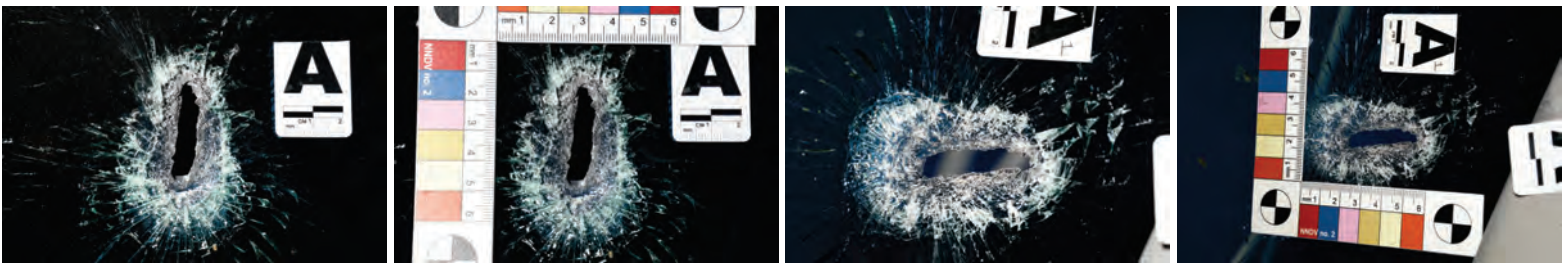
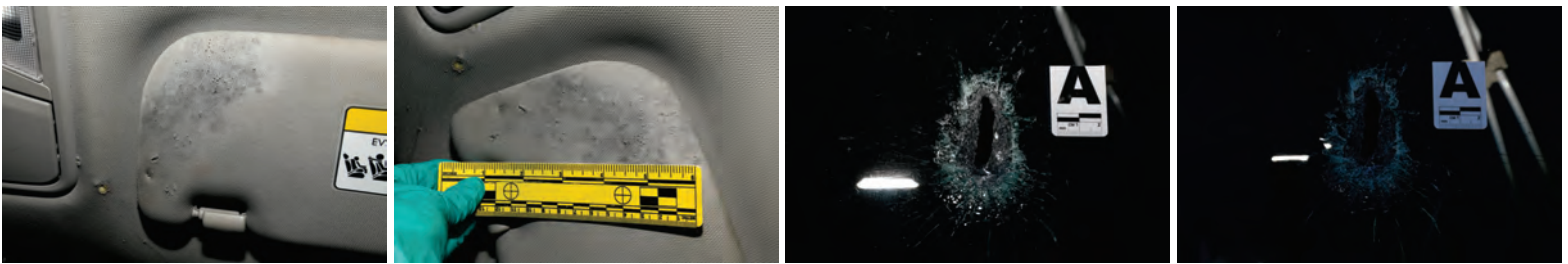

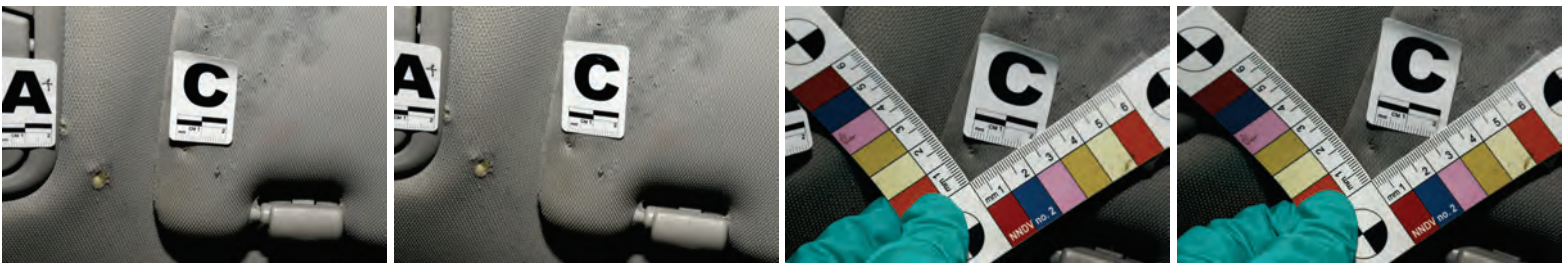
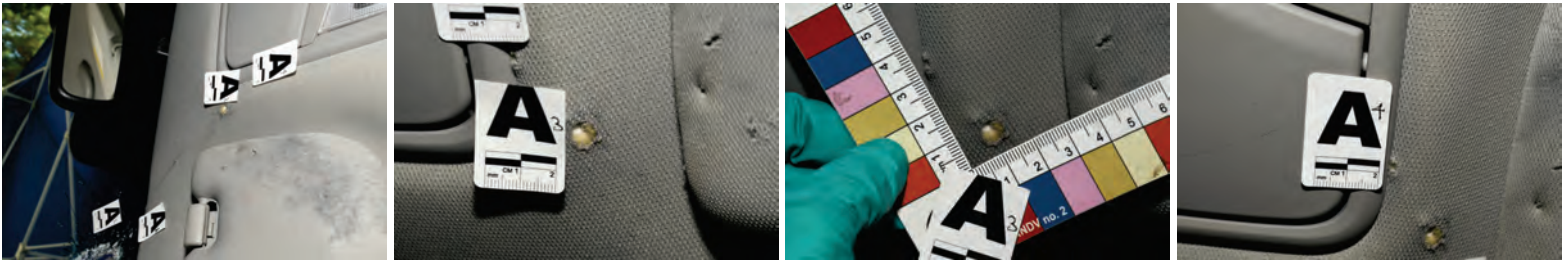

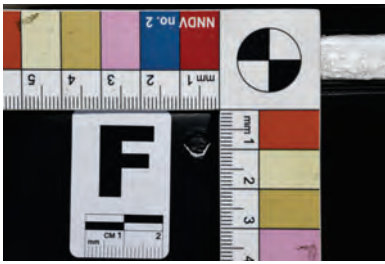
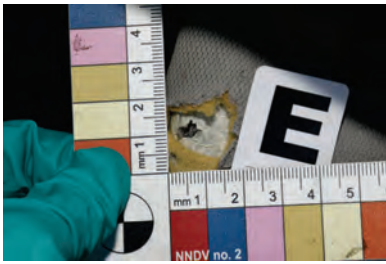

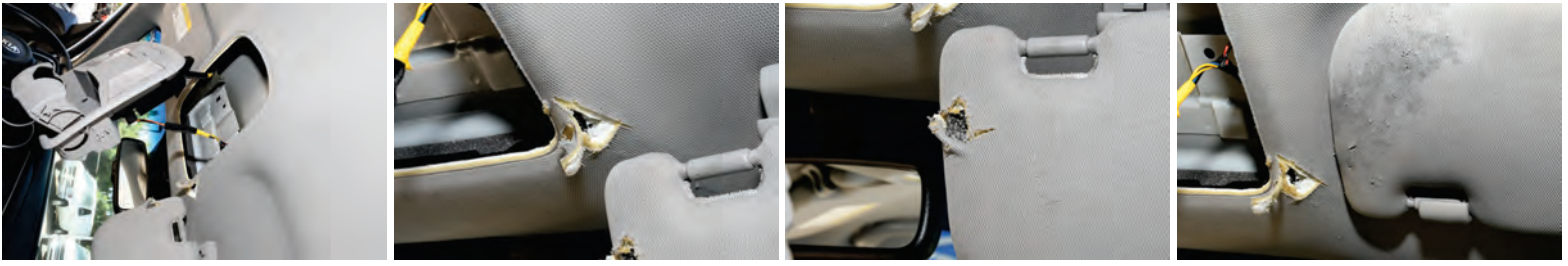

191023109
8/21/19
OFS / 101pc 200
L-VELIN #1123



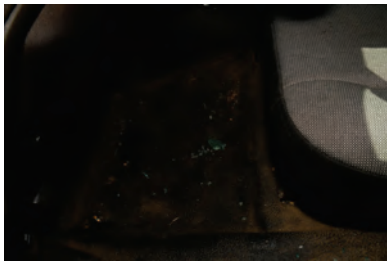





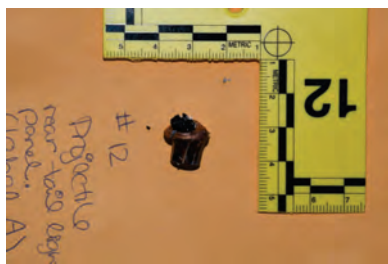
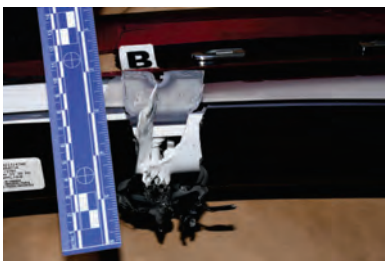

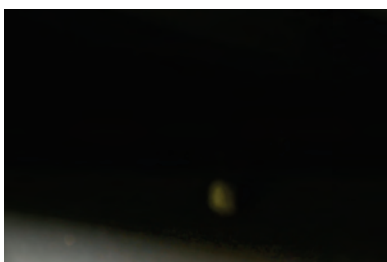
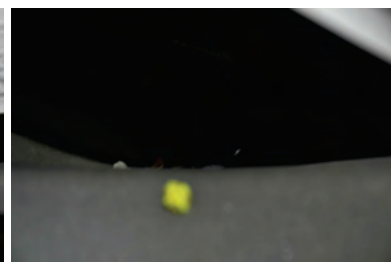

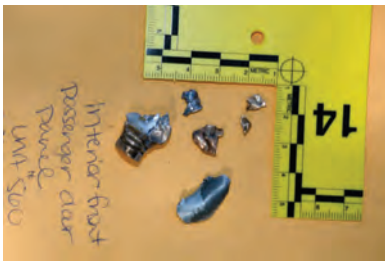

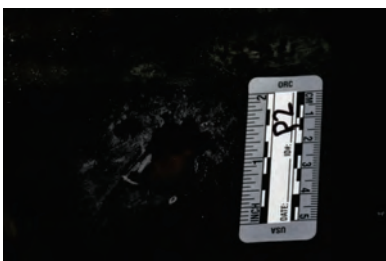
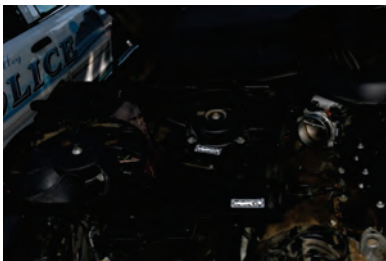

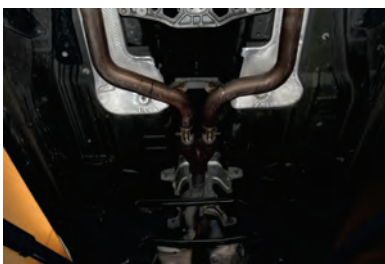
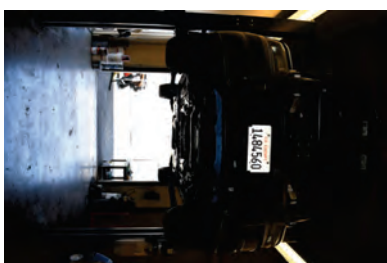

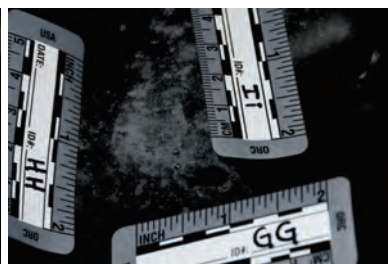
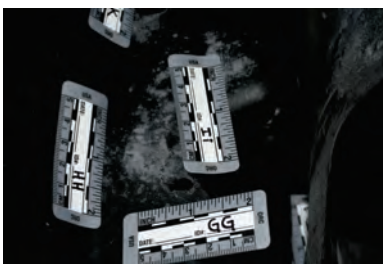
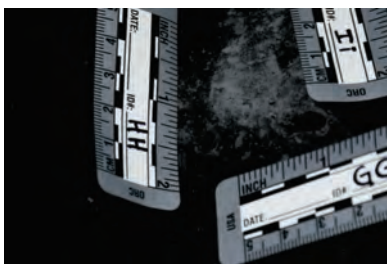
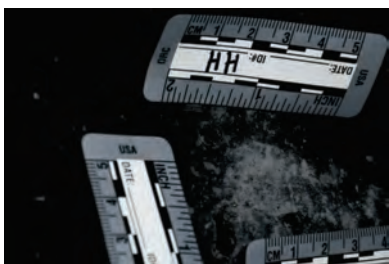
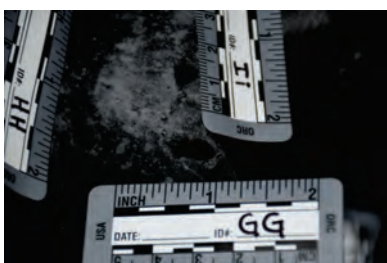
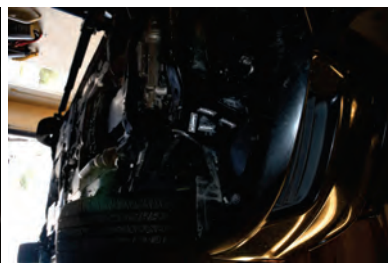

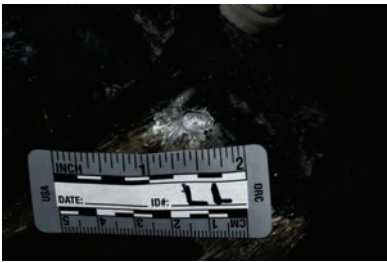
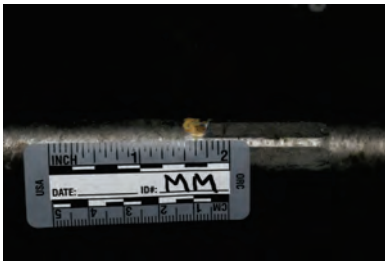

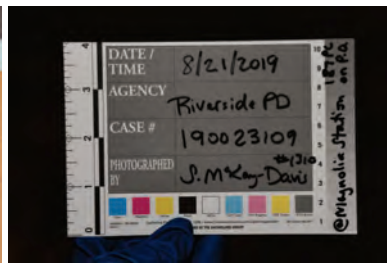
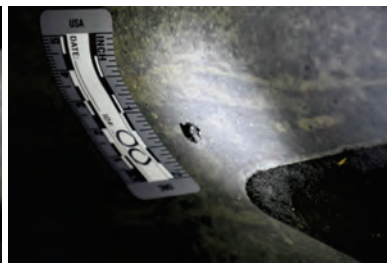
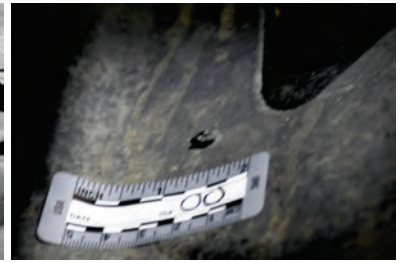
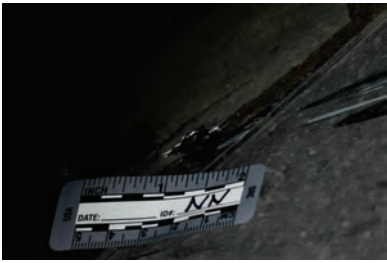

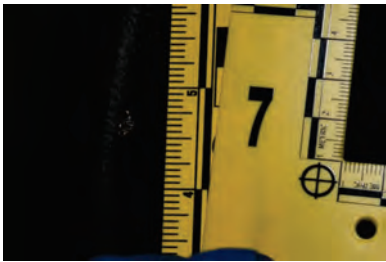



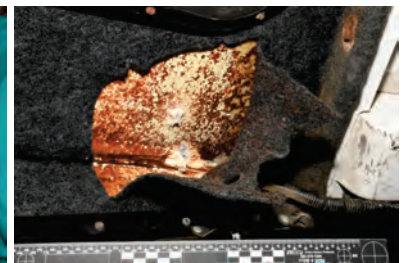
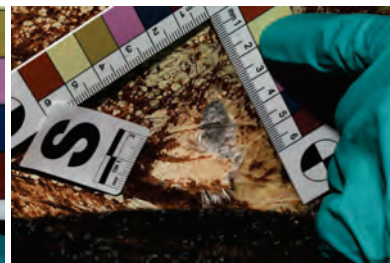
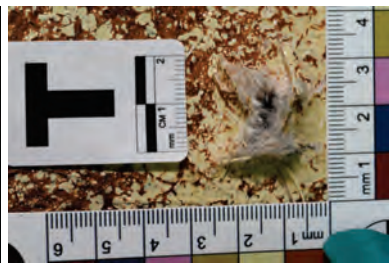
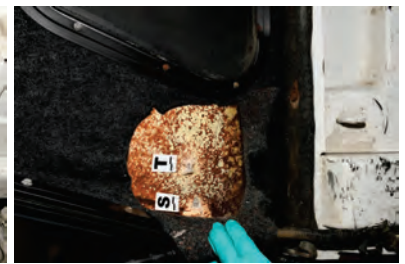
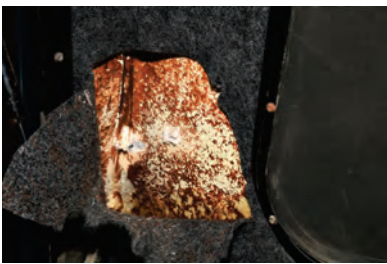
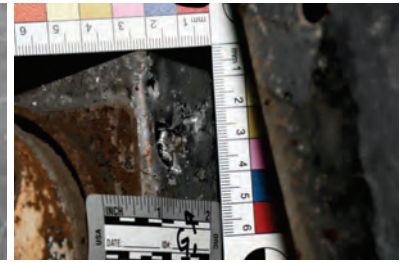

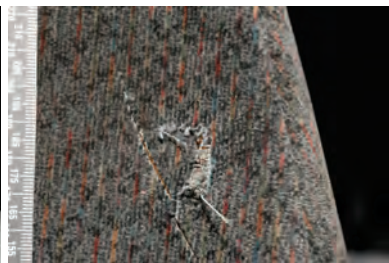
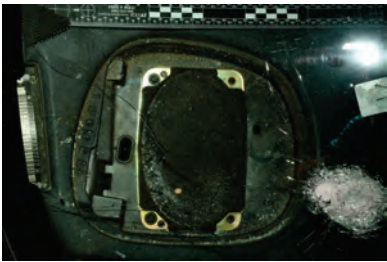
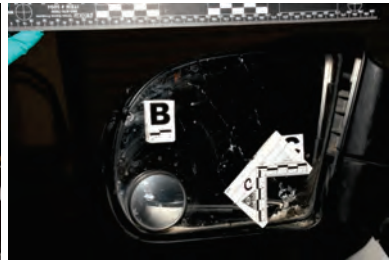
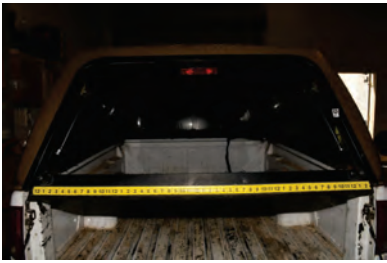

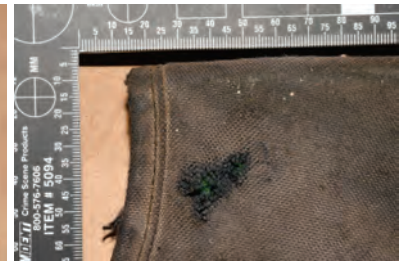
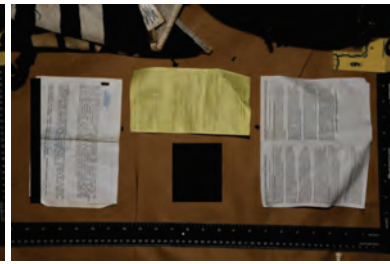
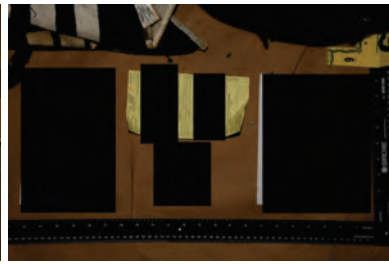
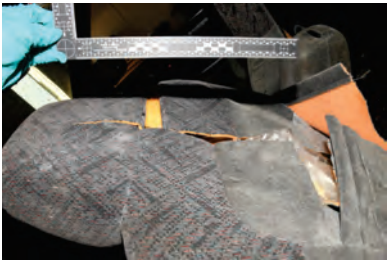



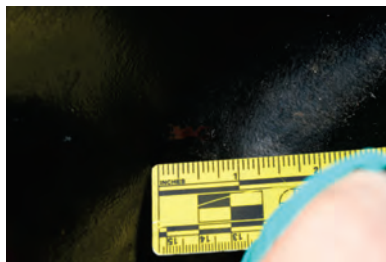

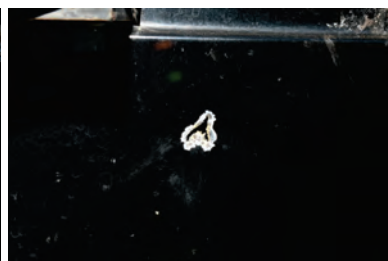
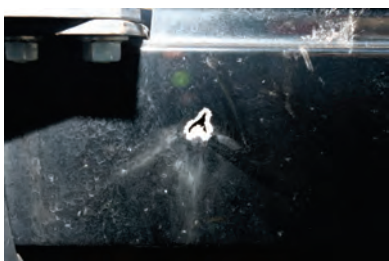

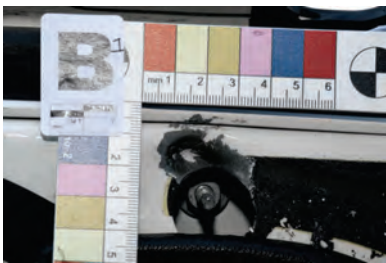
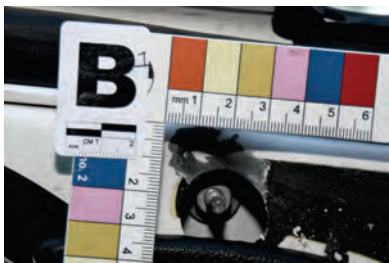



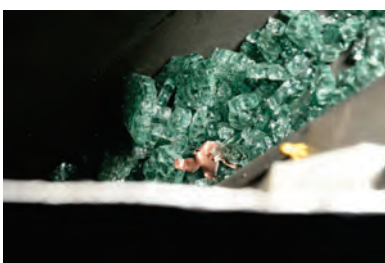
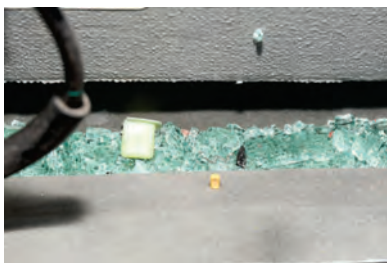

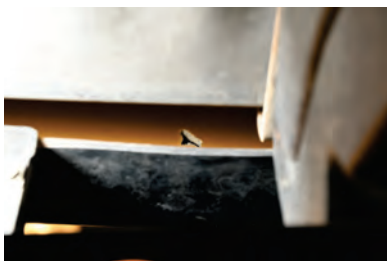
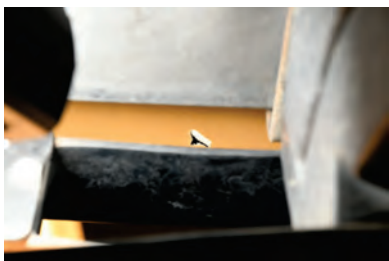

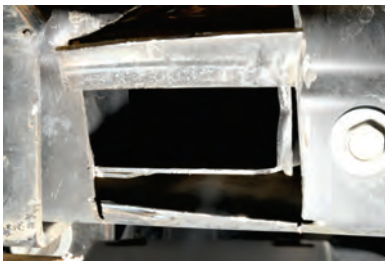

190023109
OIS-187 APD
8/22/19
L-VEUW#1723



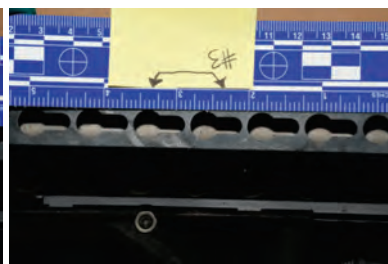
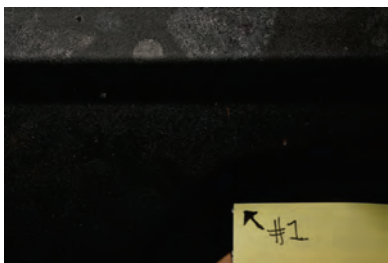

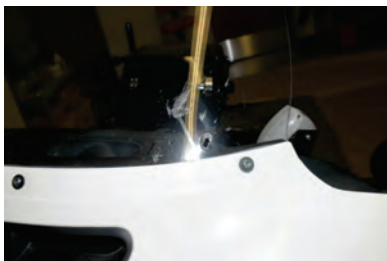
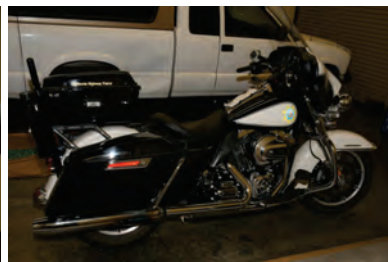
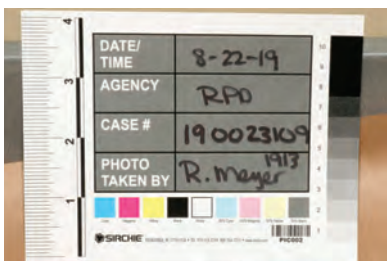

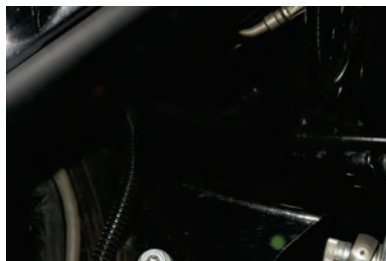
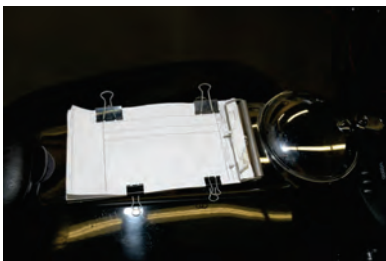
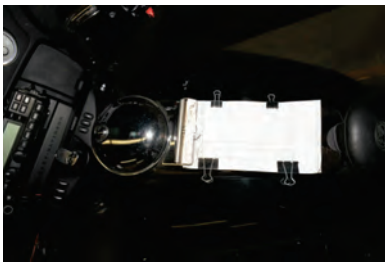

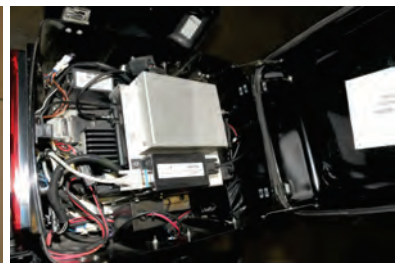
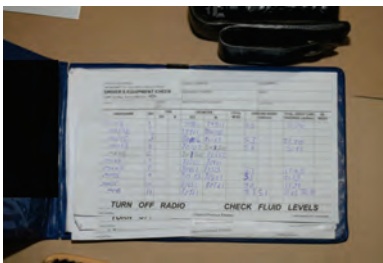
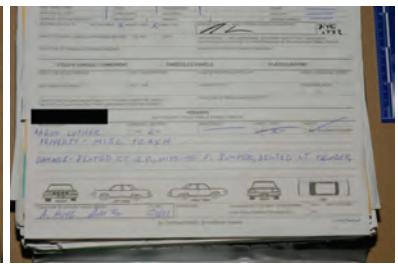
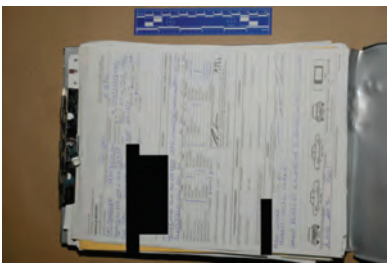
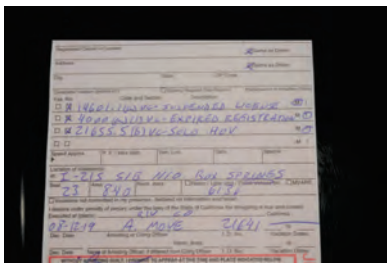
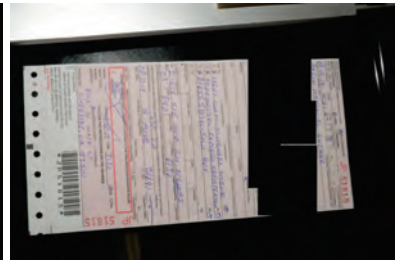
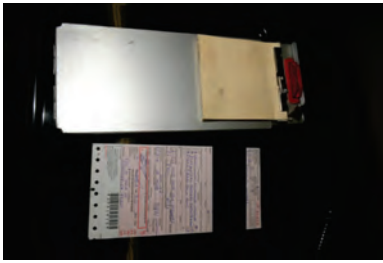

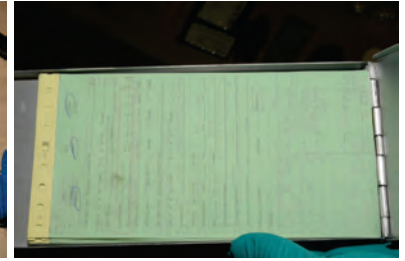





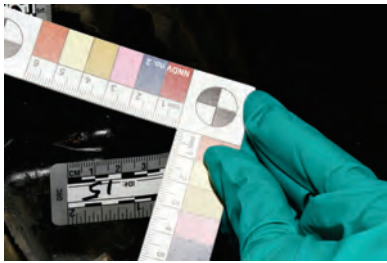
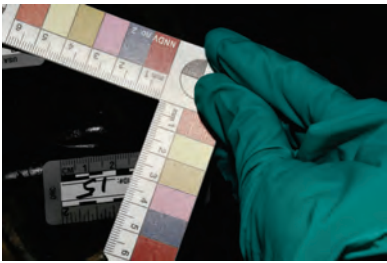
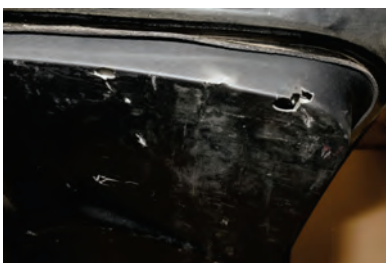
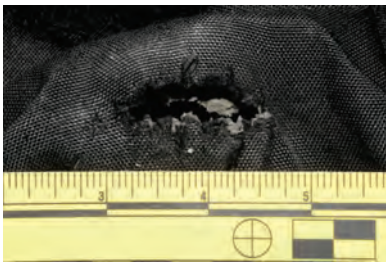

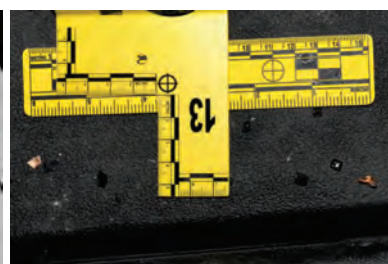
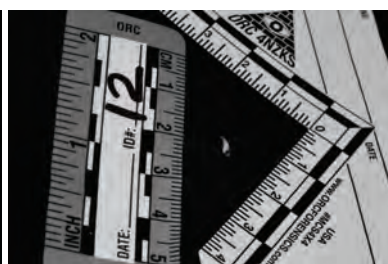
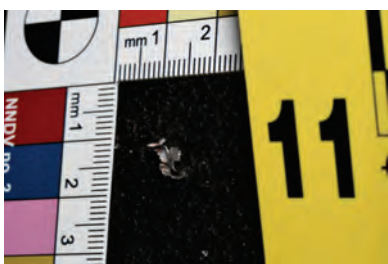
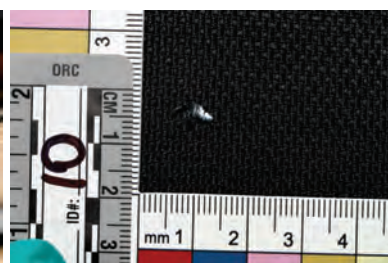
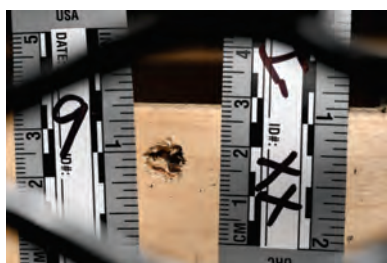
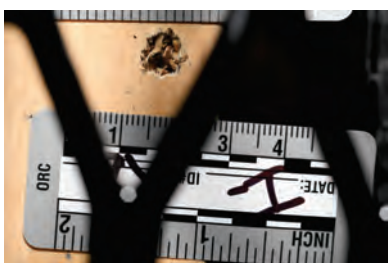

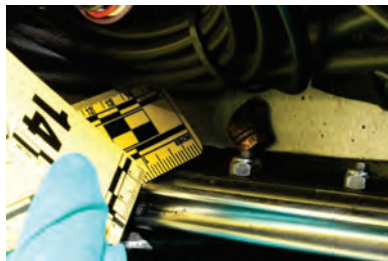

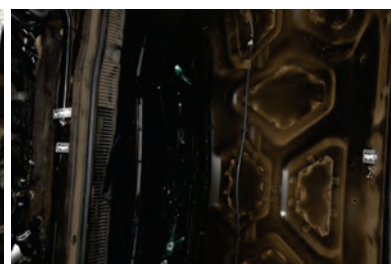
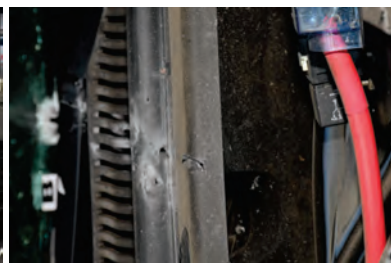





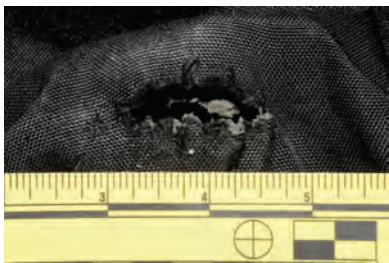

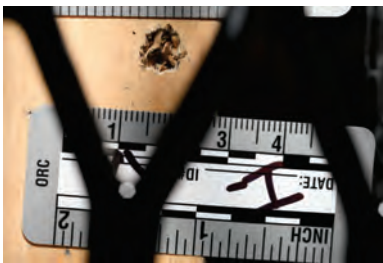
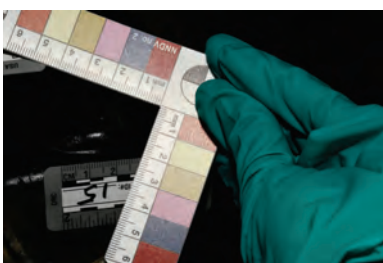

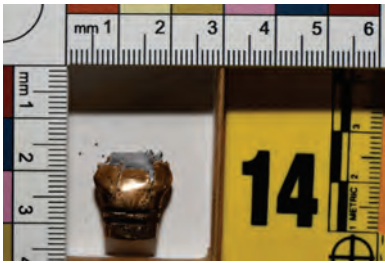
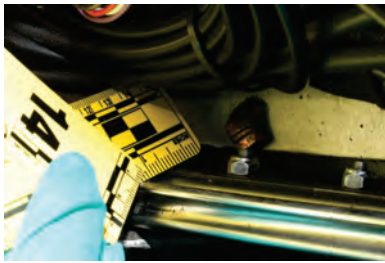
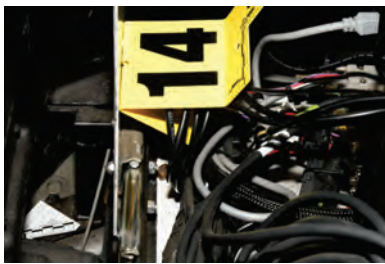
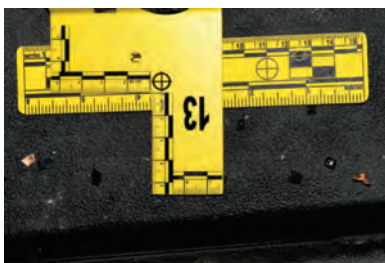
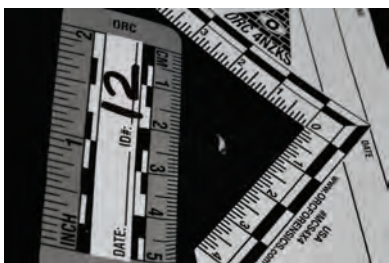
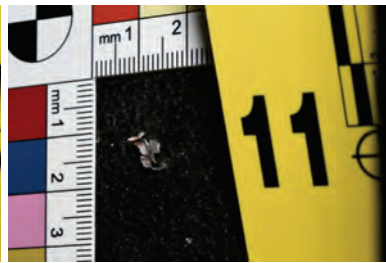
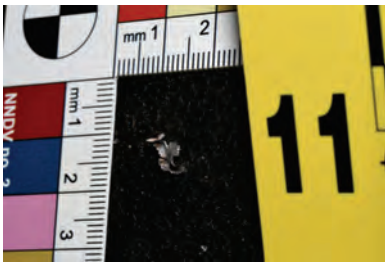
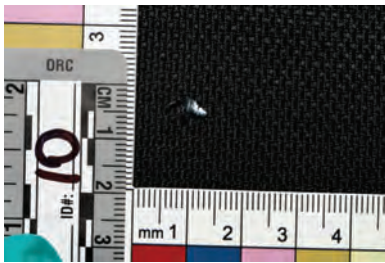



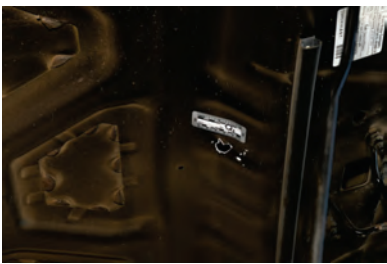

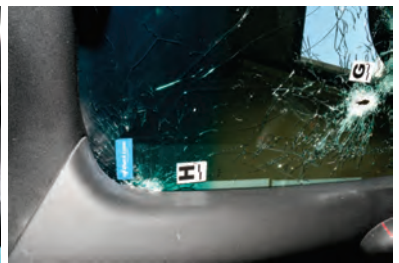
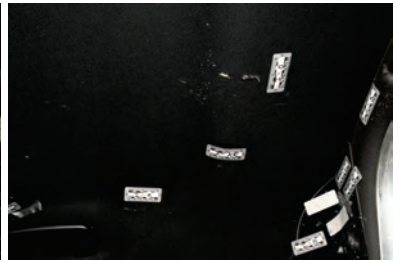

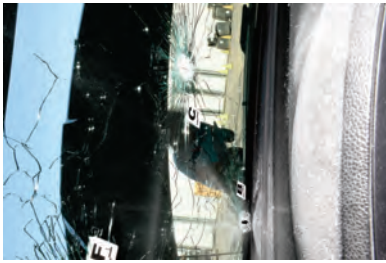
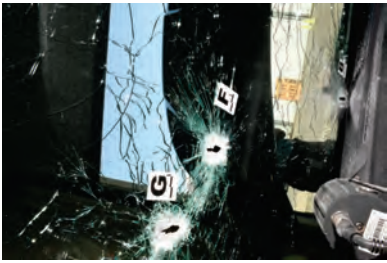

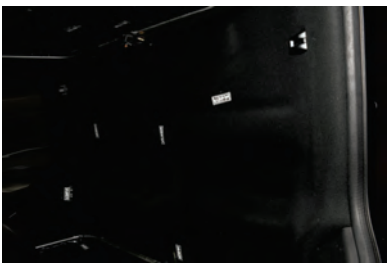
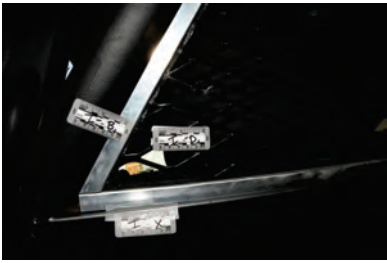



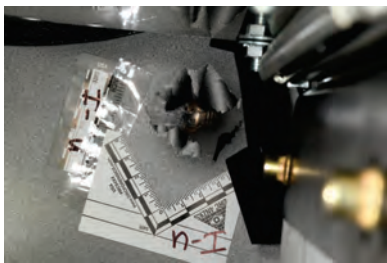
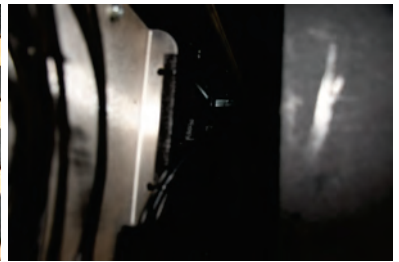
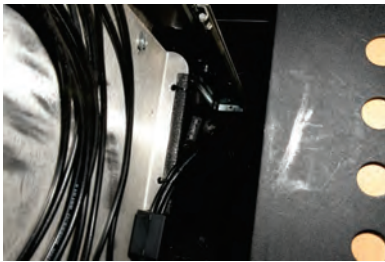
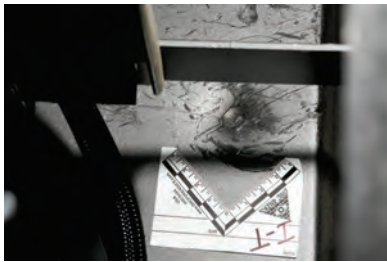
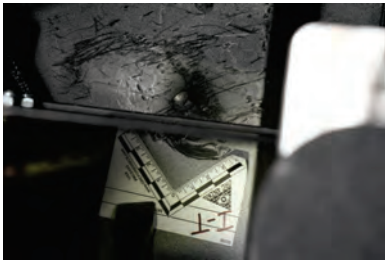

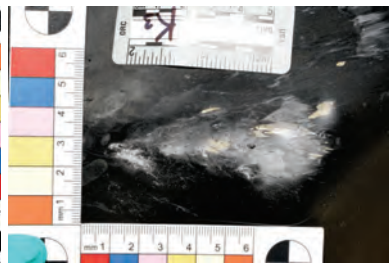
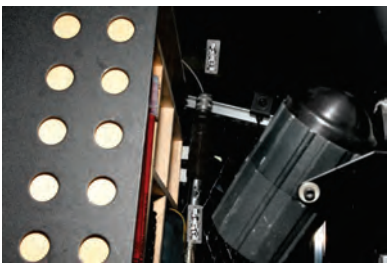

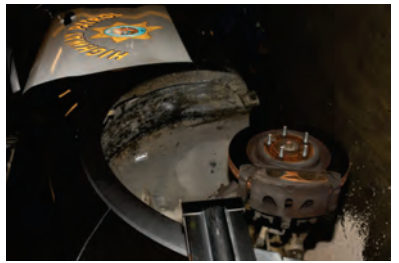
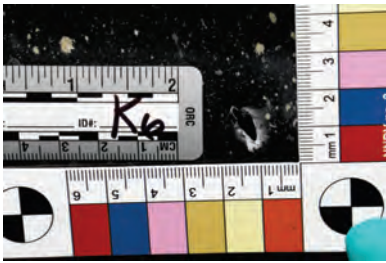
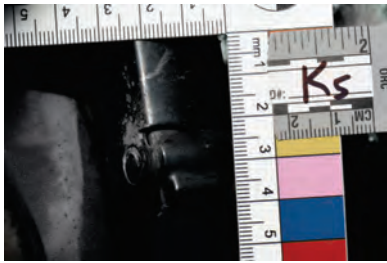
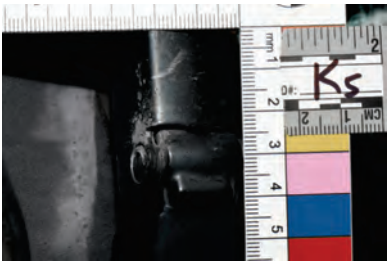
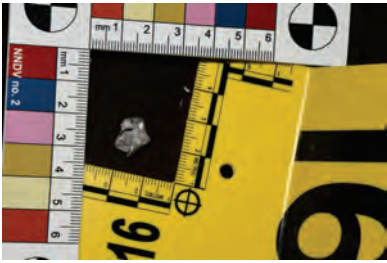

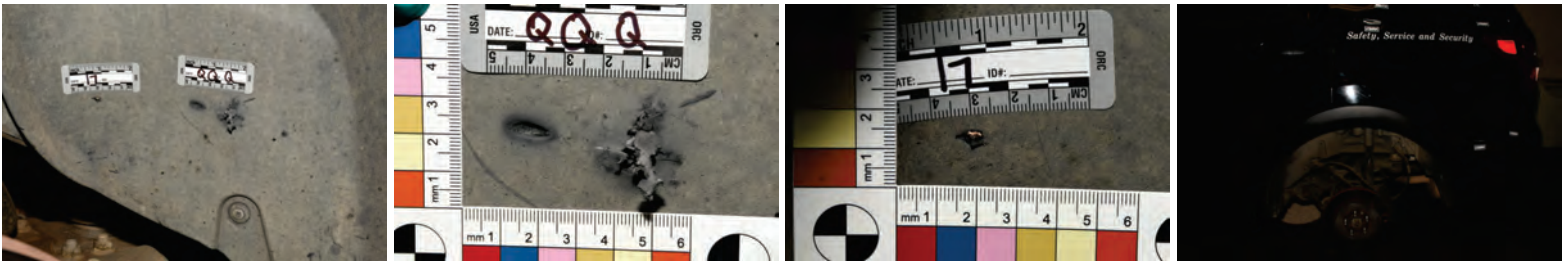
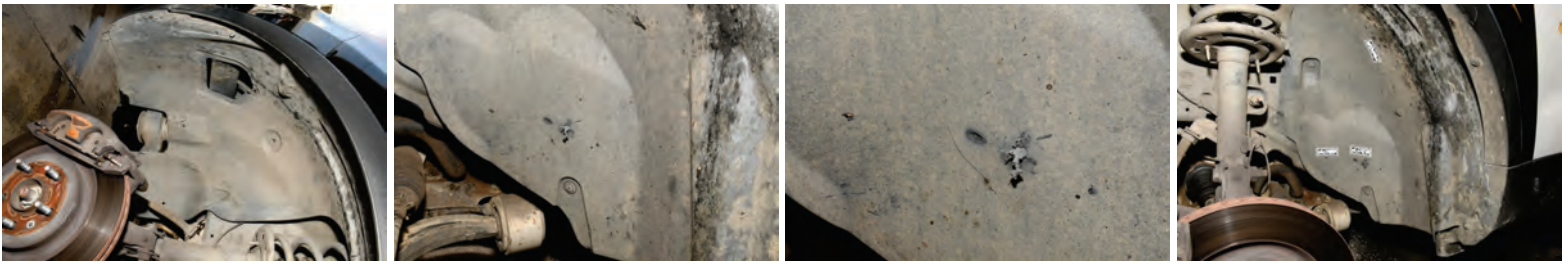



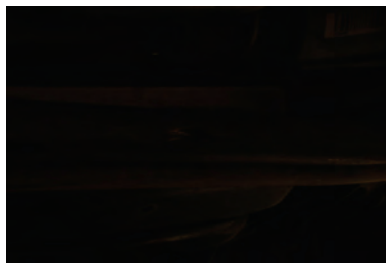
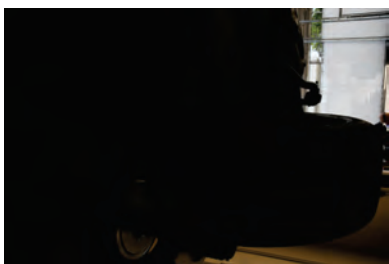







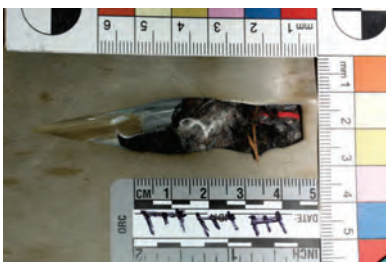
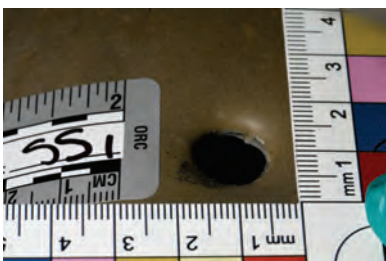
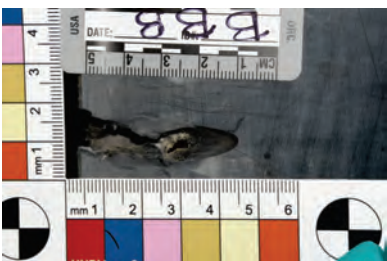
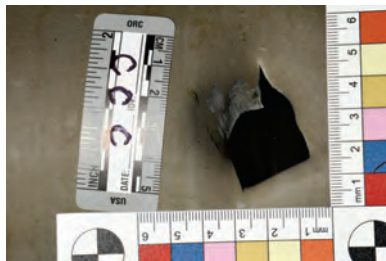
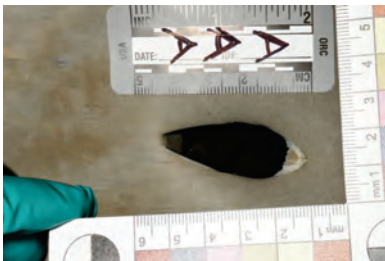

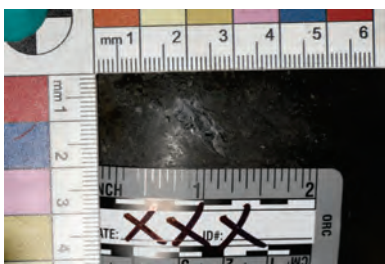
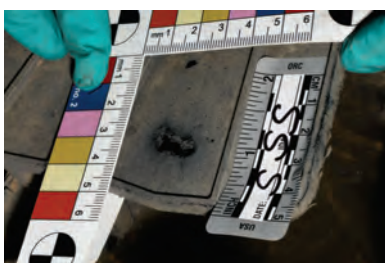
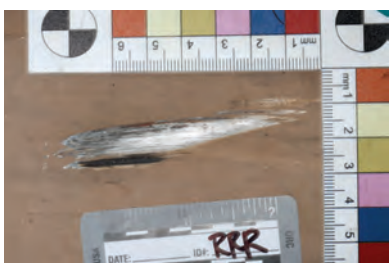
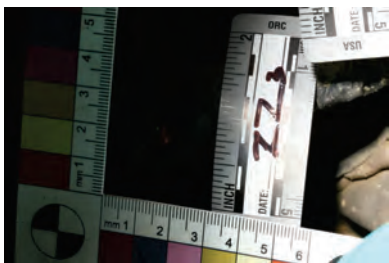

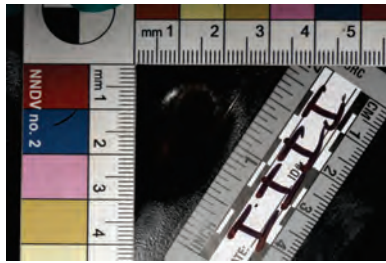
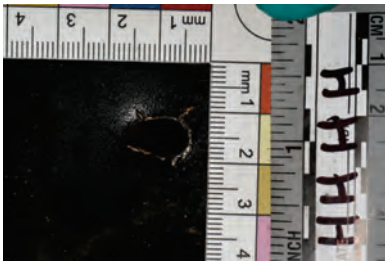
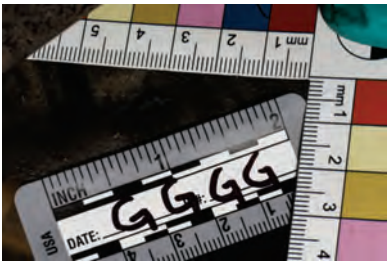
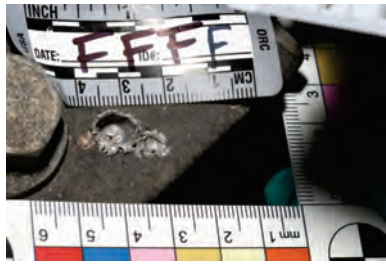
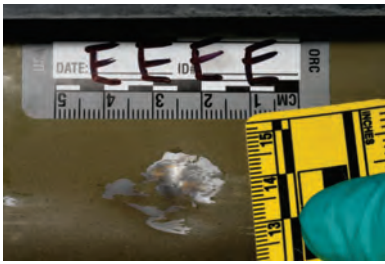
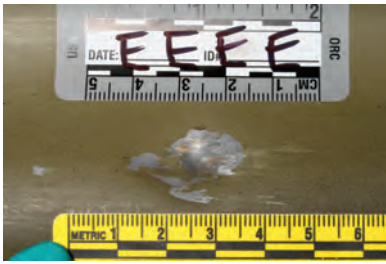
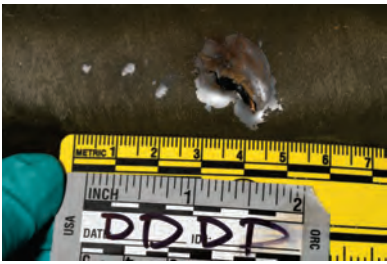
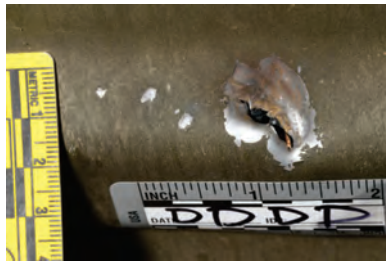
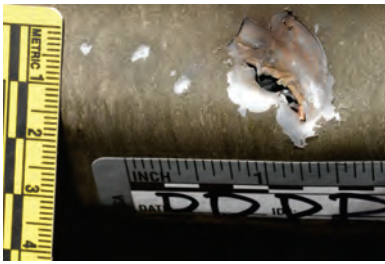
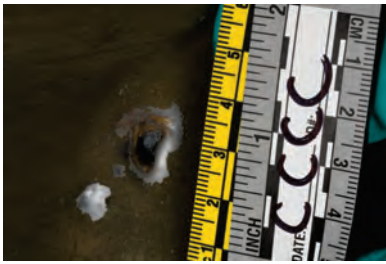
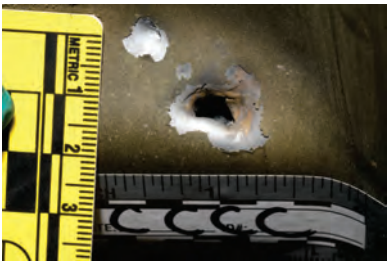
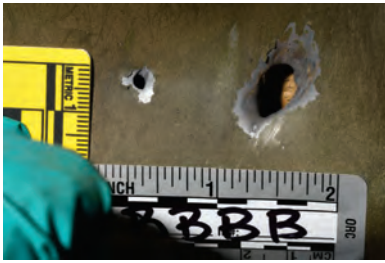
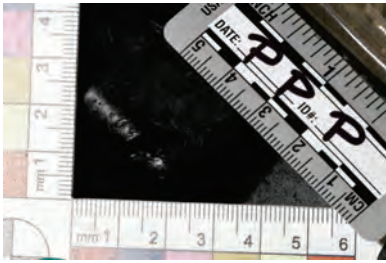

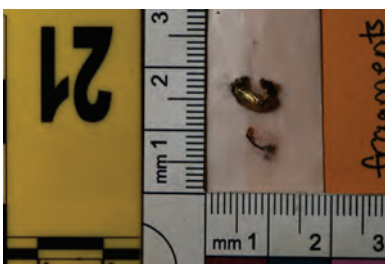
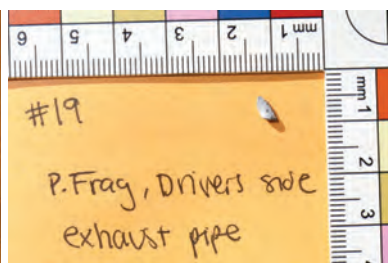
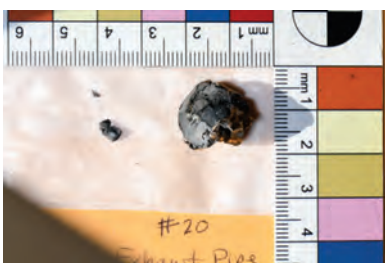
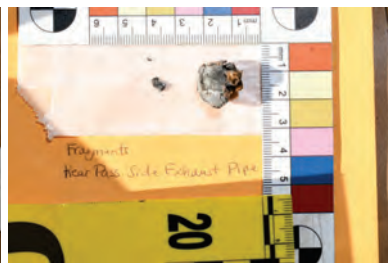
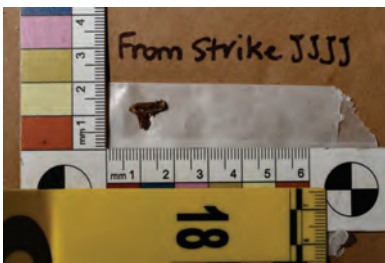
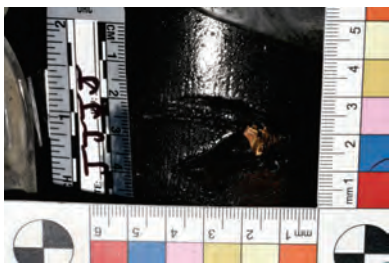



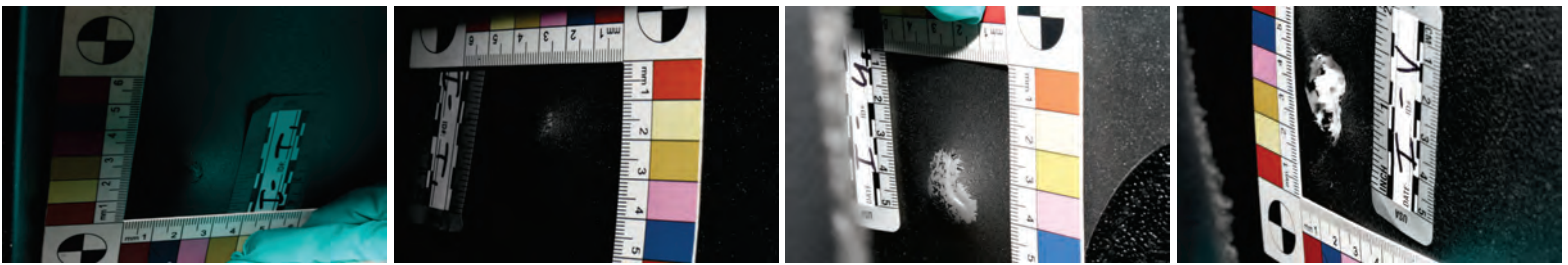
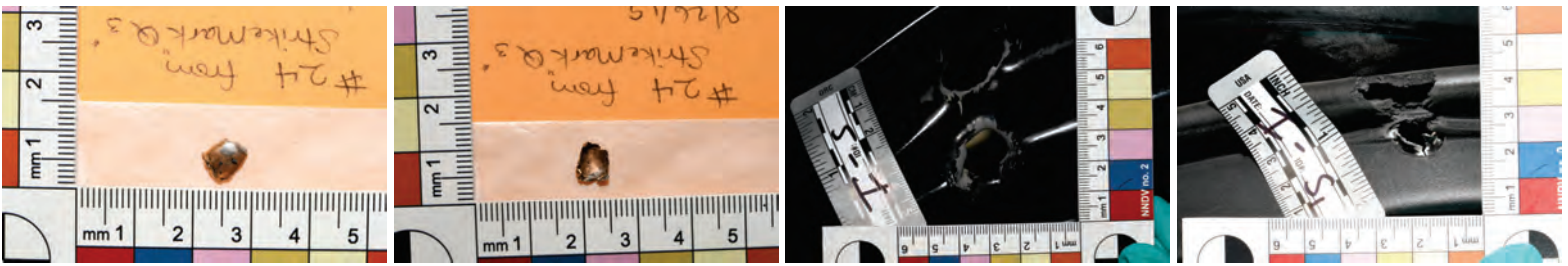
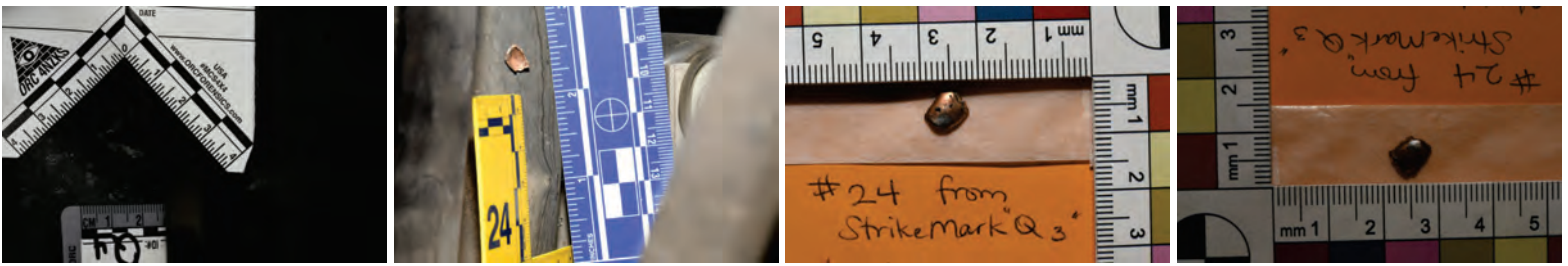

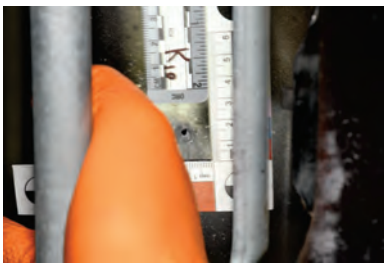
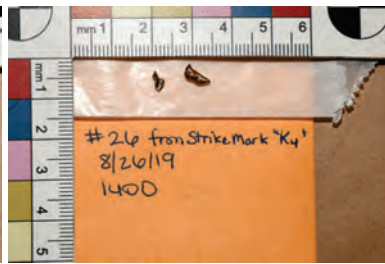
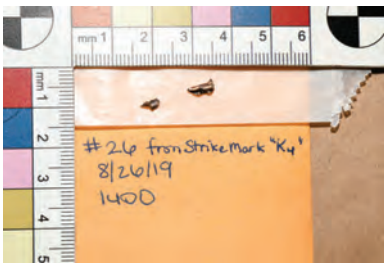
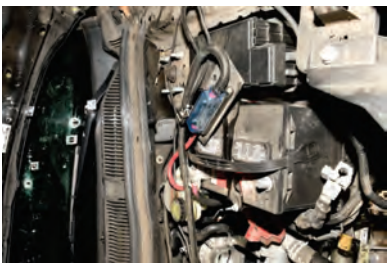
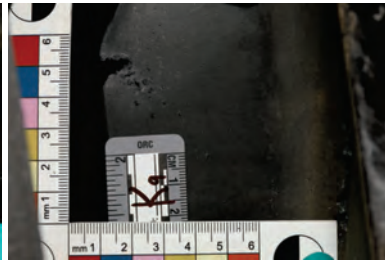
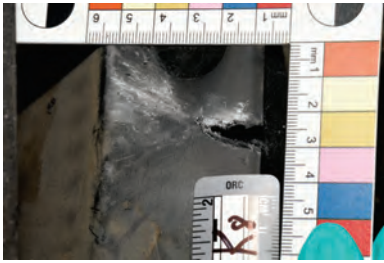

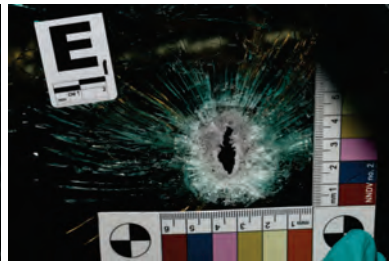
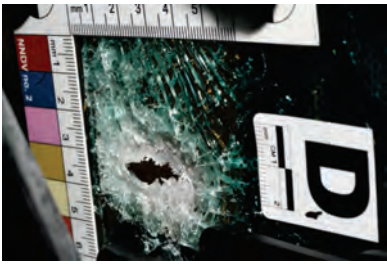
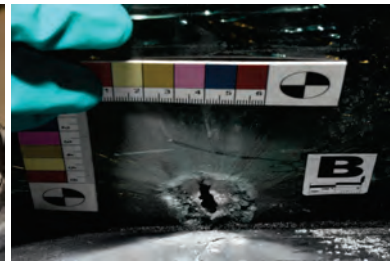

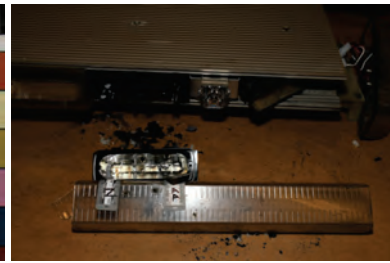
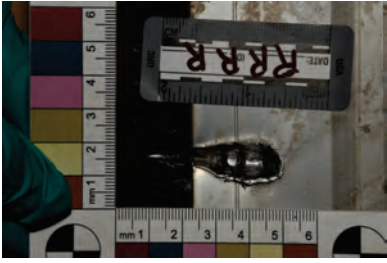
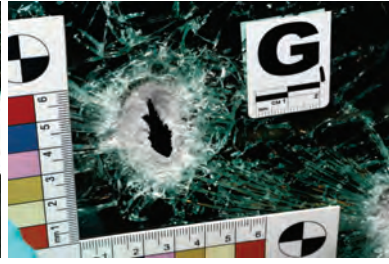
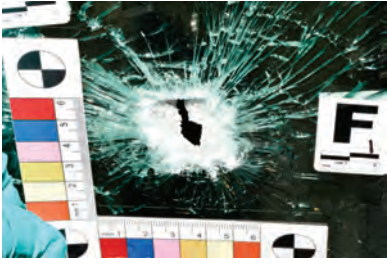

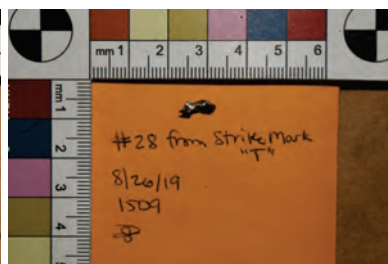
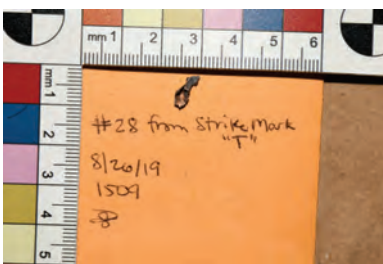
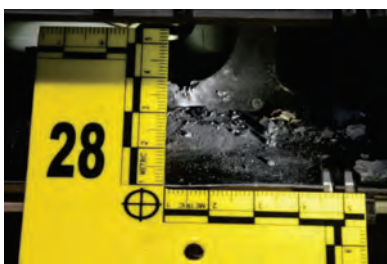
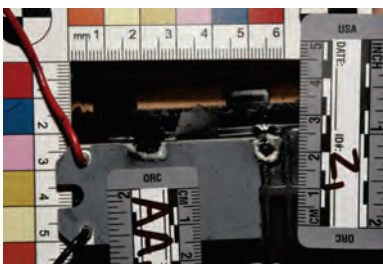
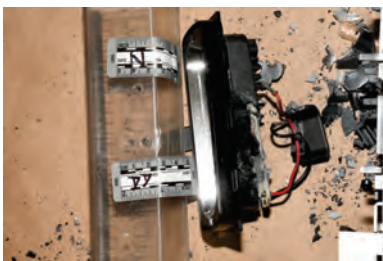

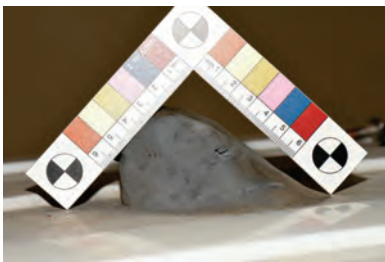
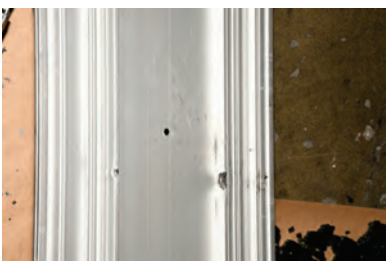

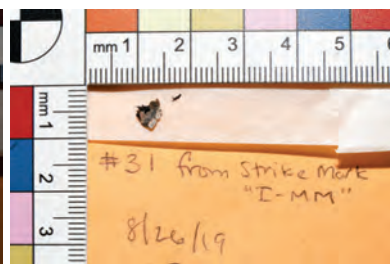
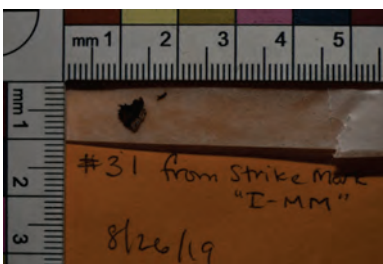
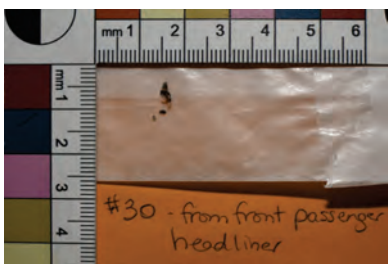
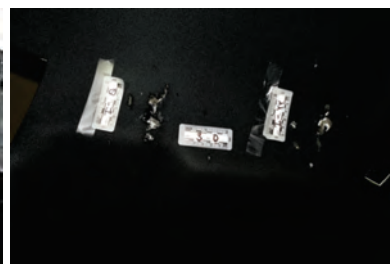
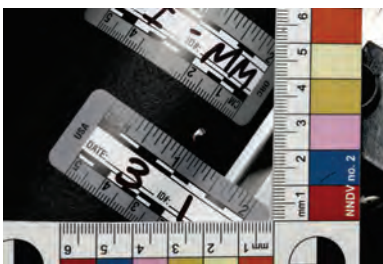
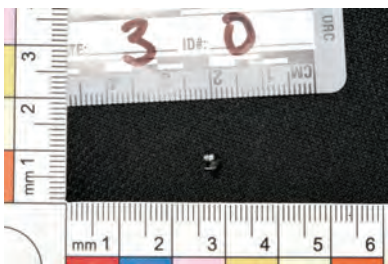
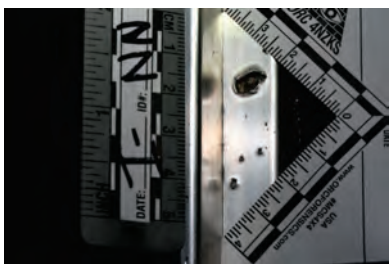
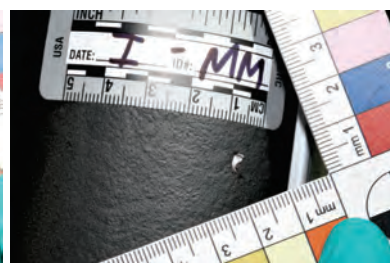
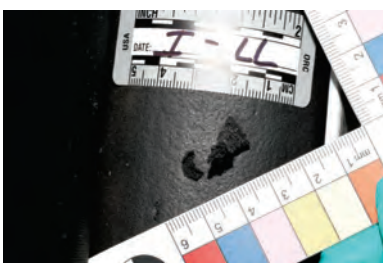
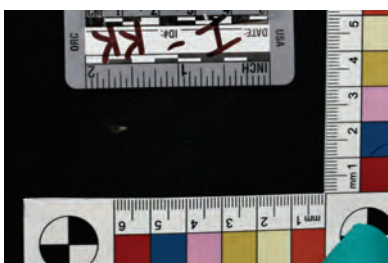

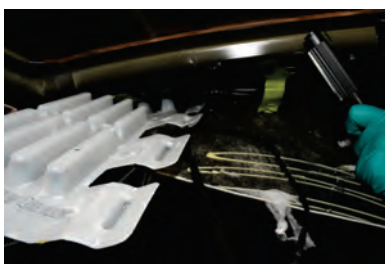
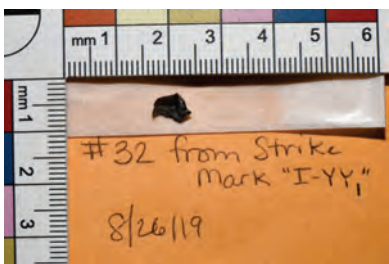
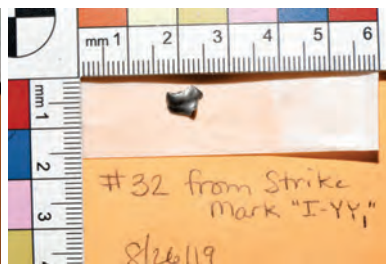
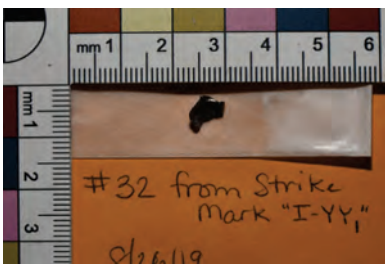
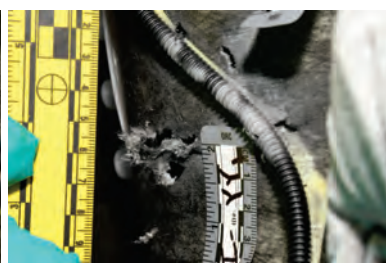
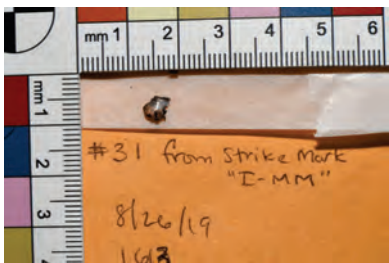

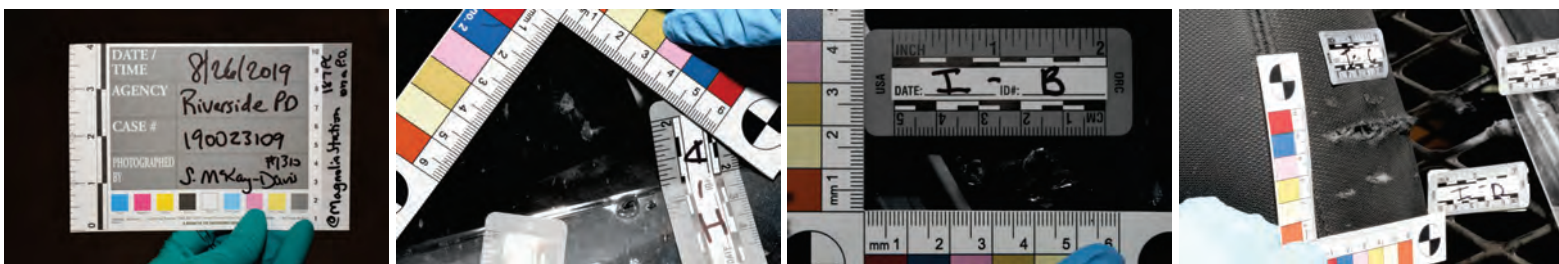
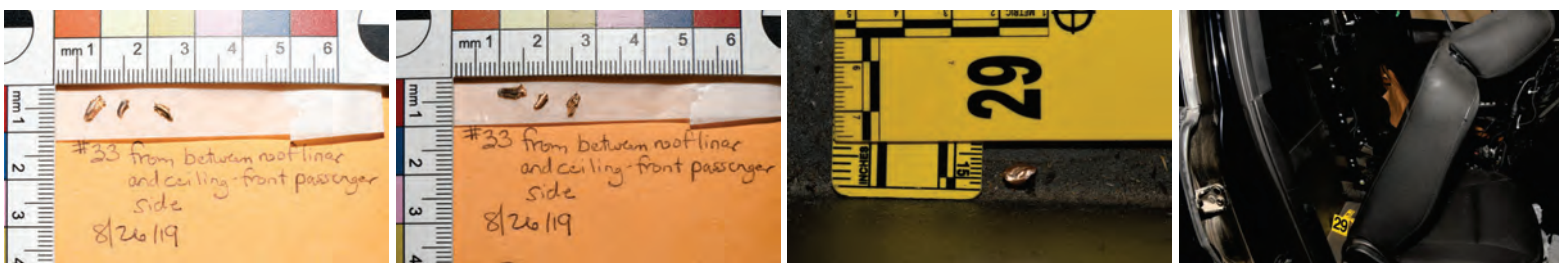
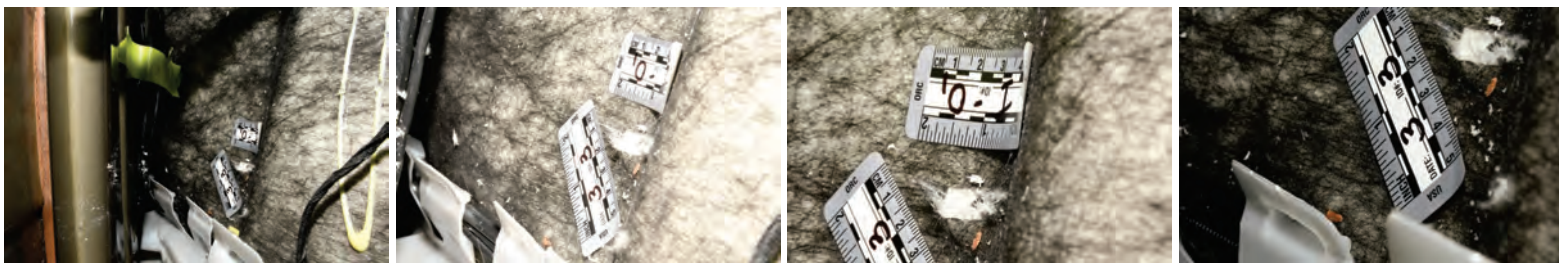

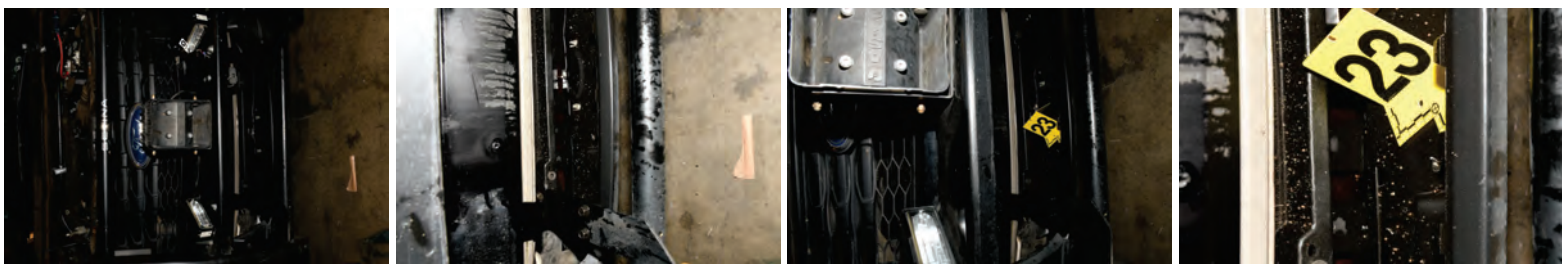
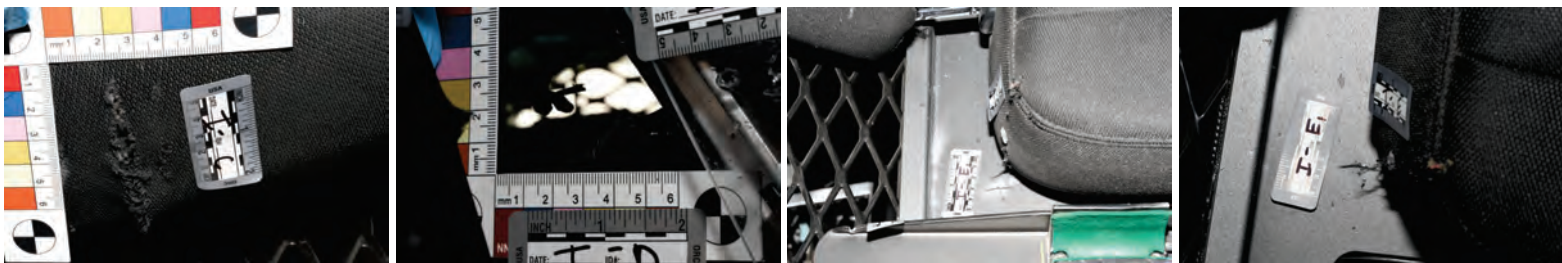

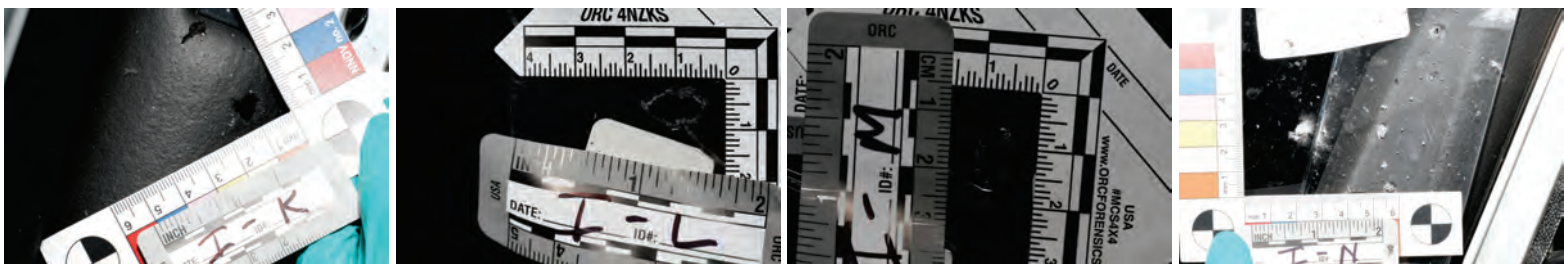

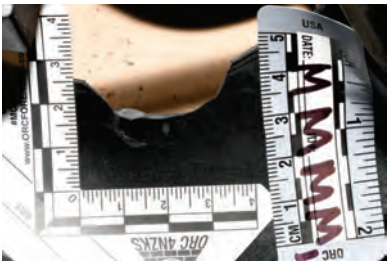
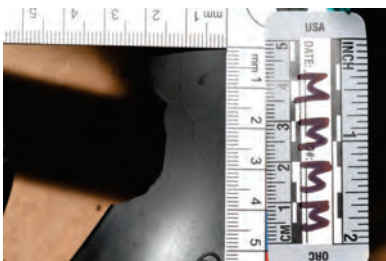
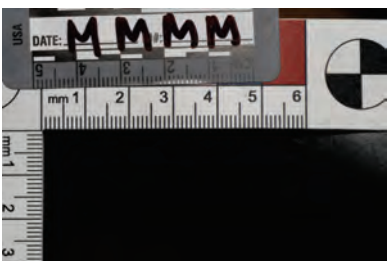
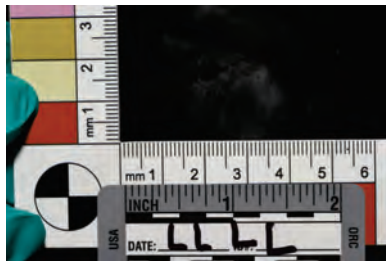

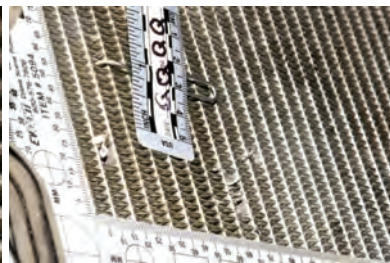
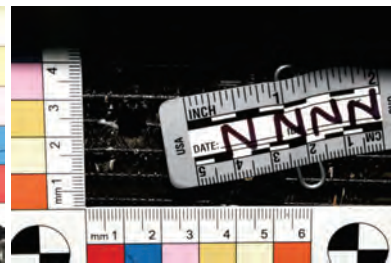
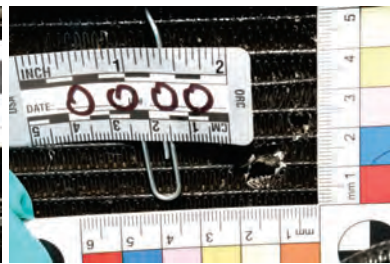

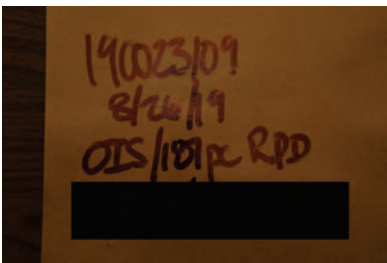
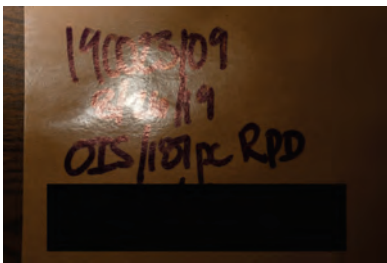
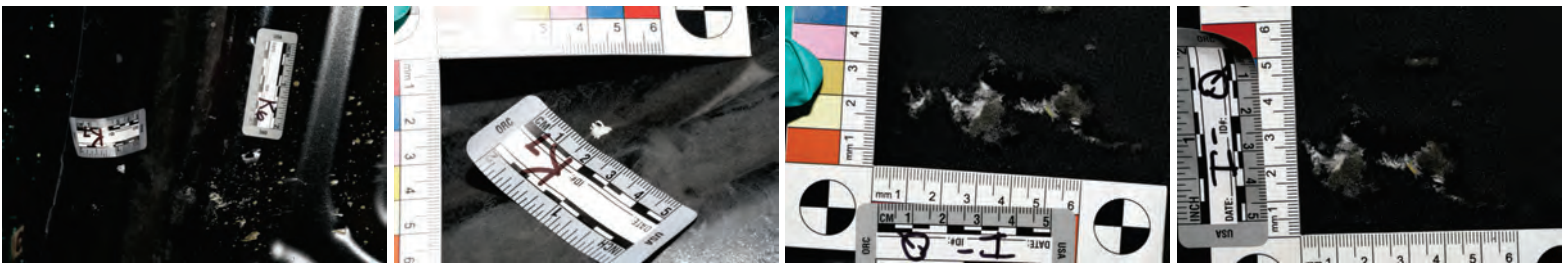
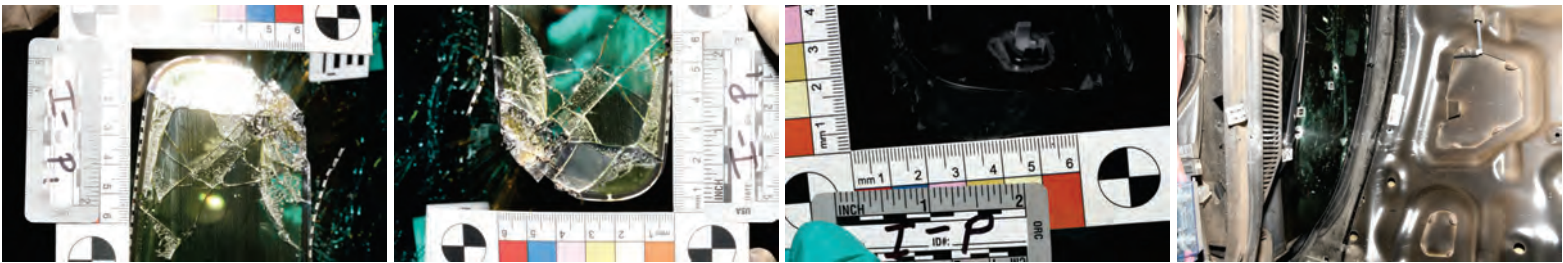

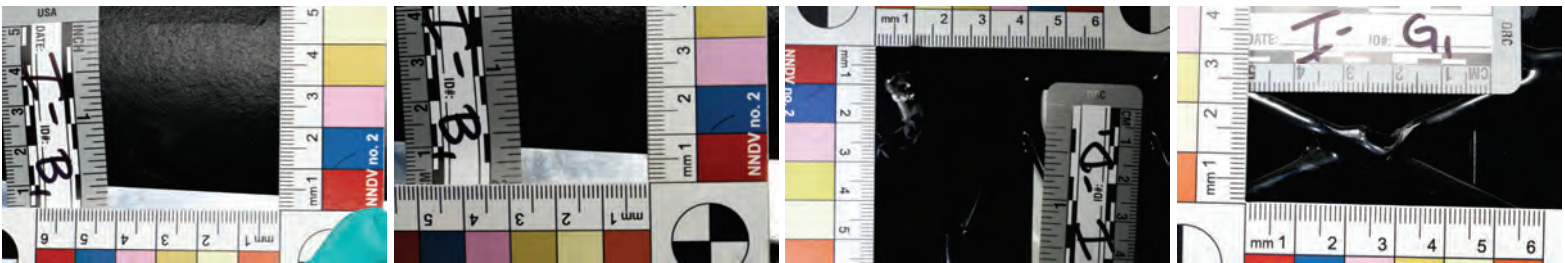
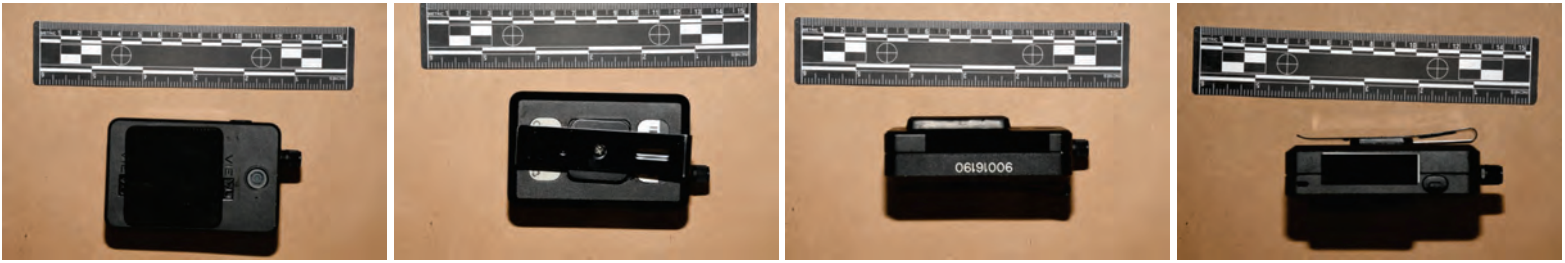

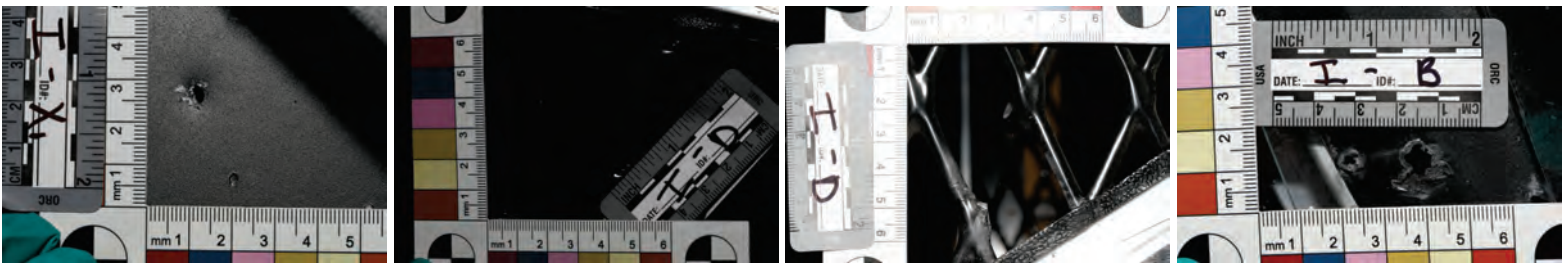
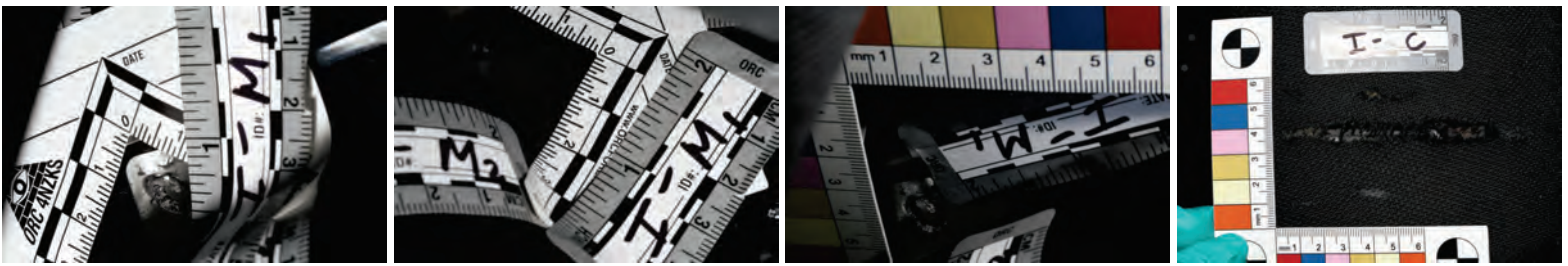
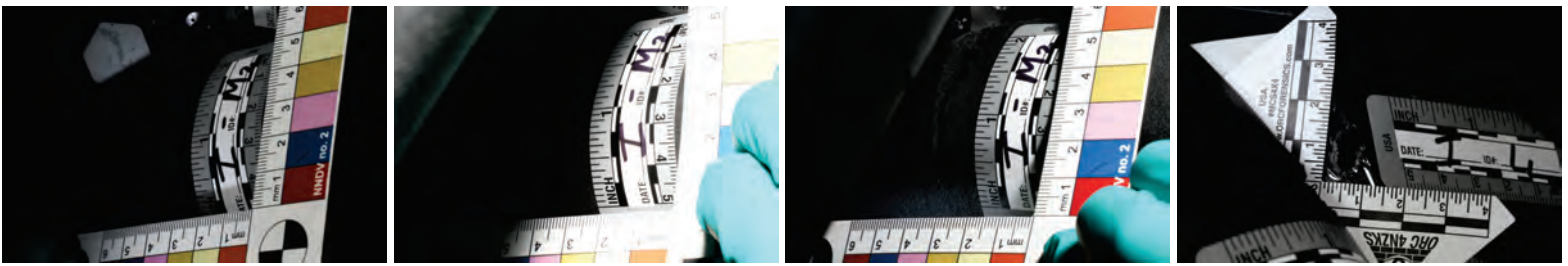
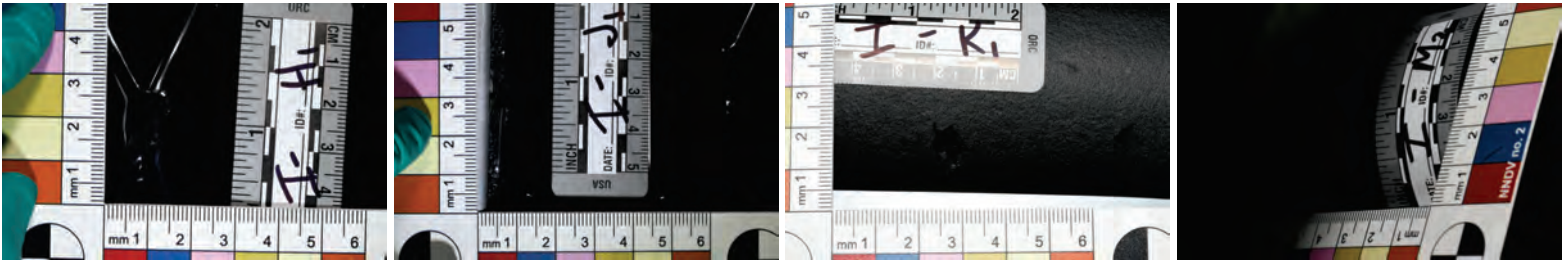

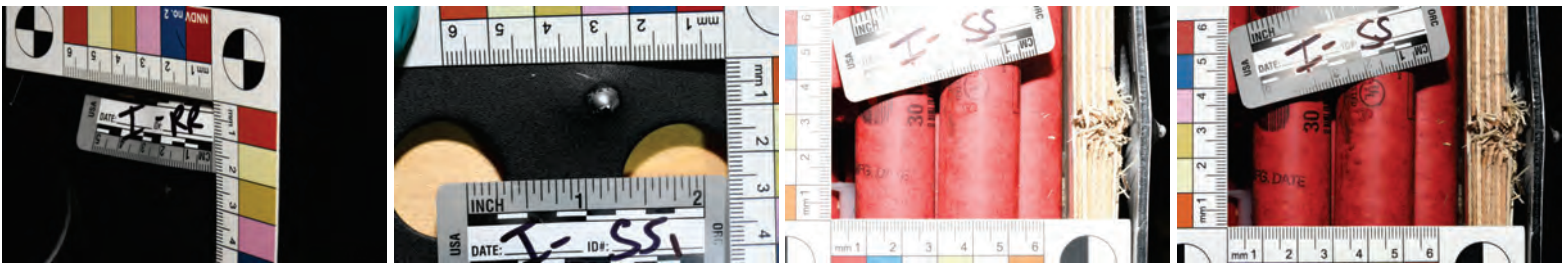

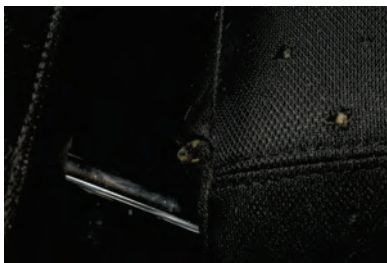
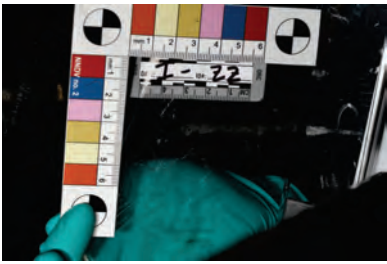
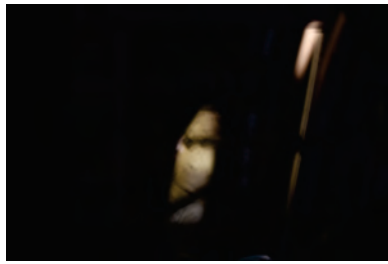
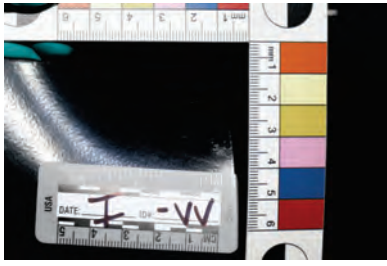
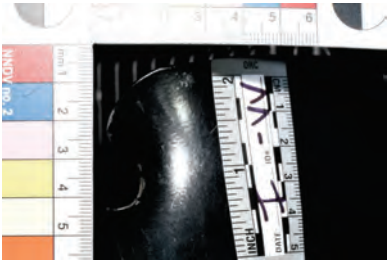

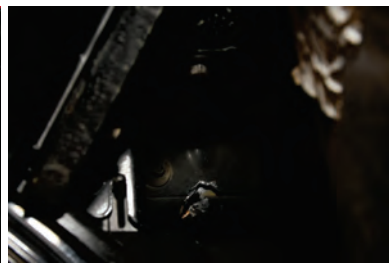
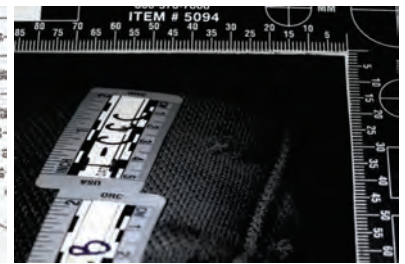
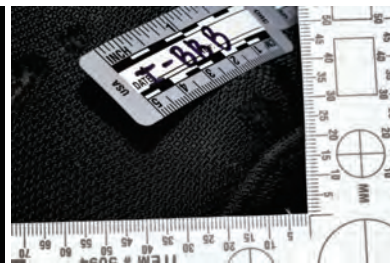



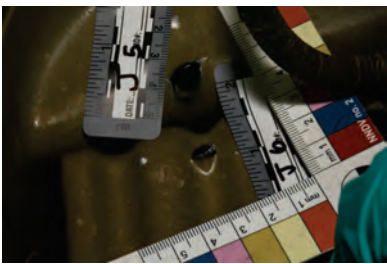
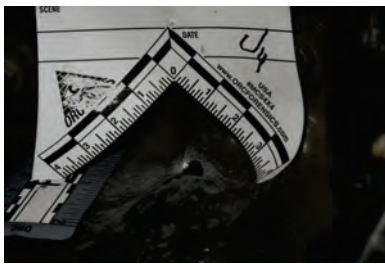

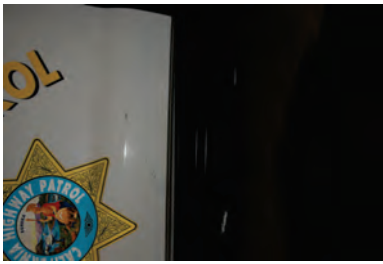
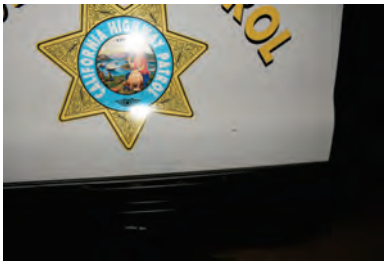
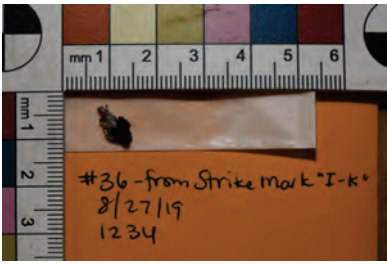
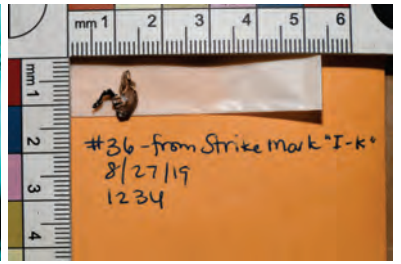
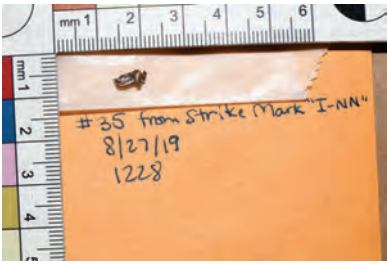
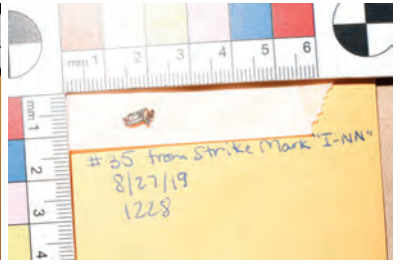
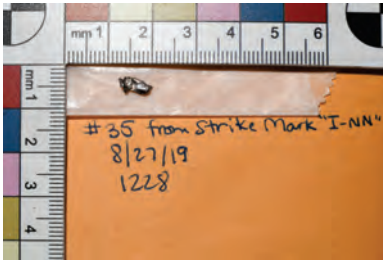
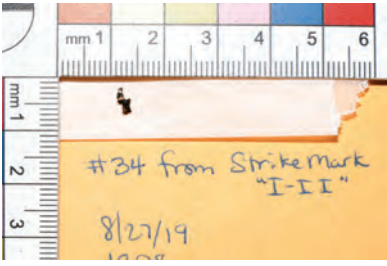

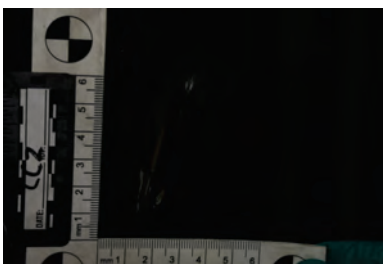
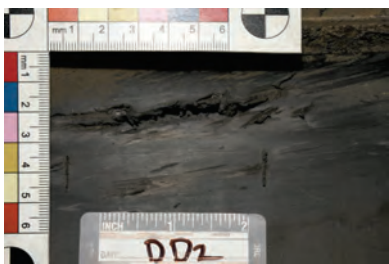
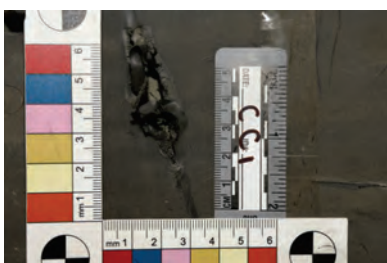

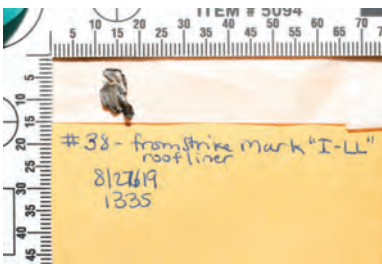
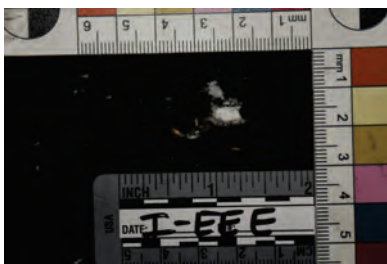
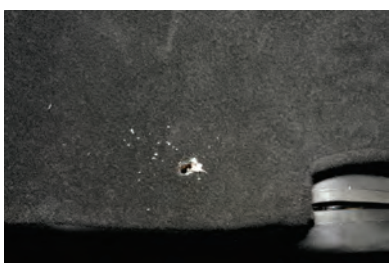
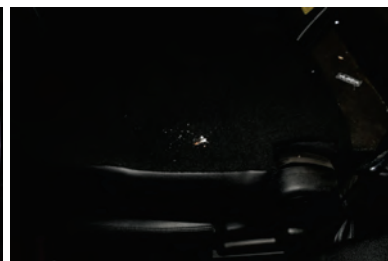
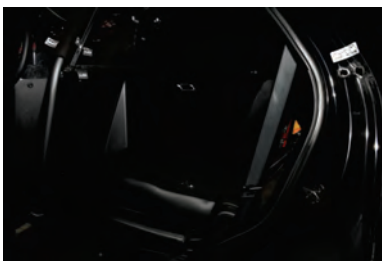
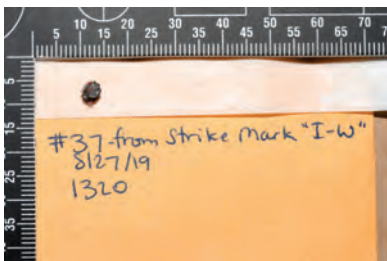
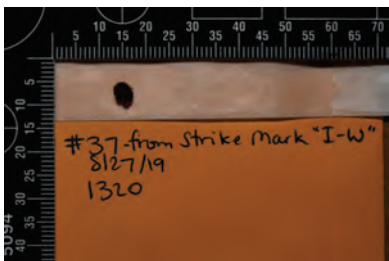

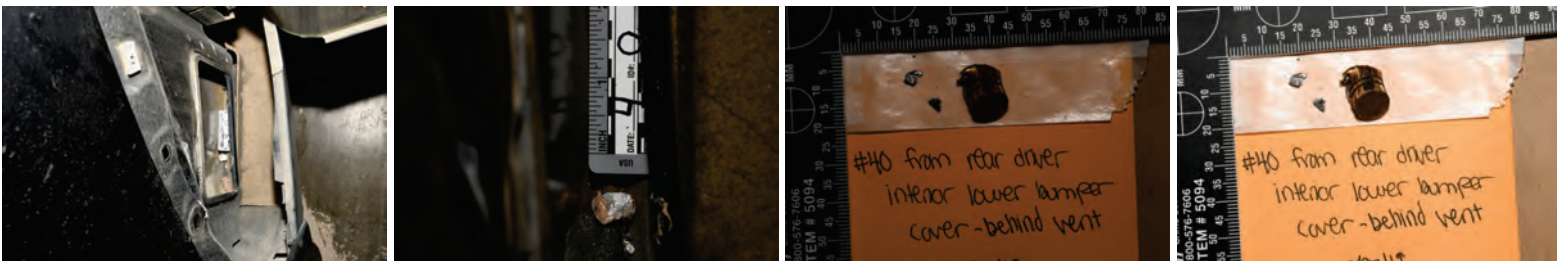
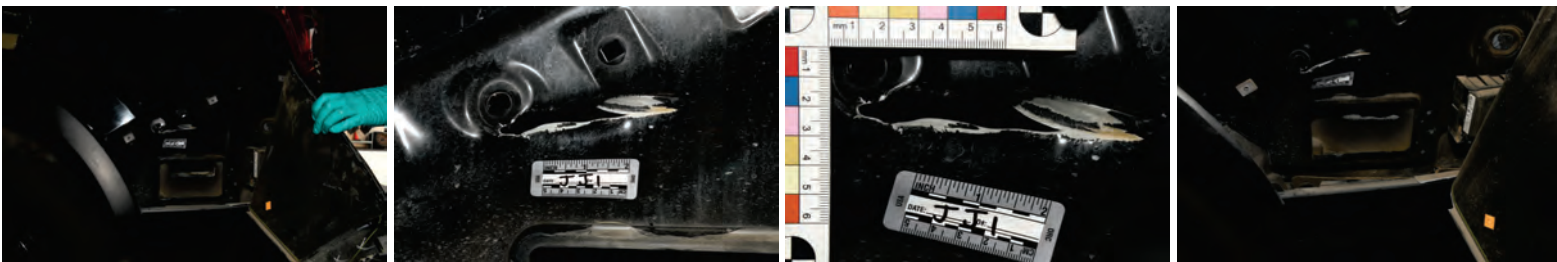
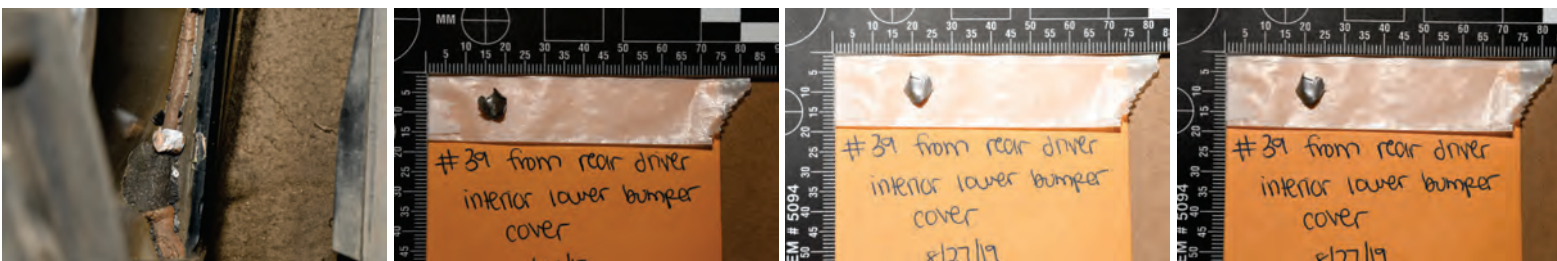
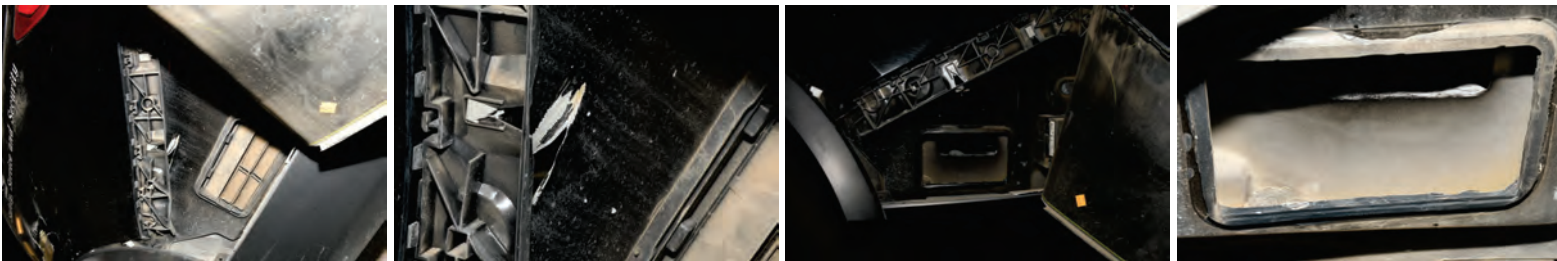

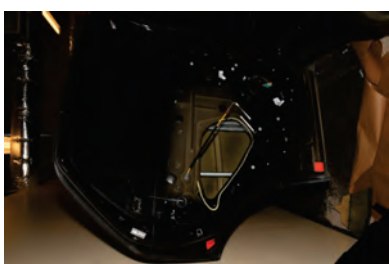
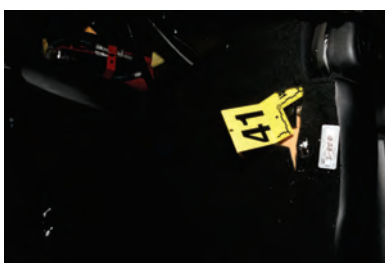
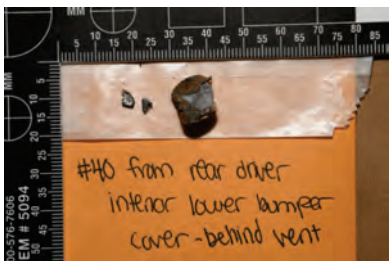

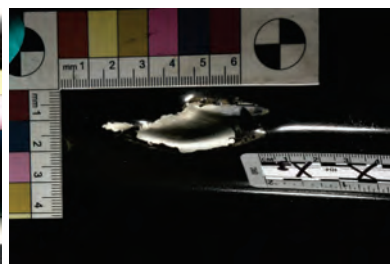
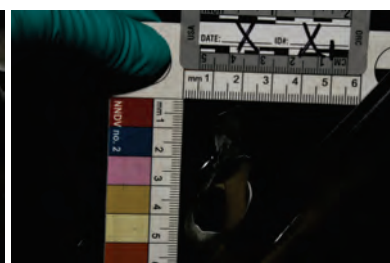
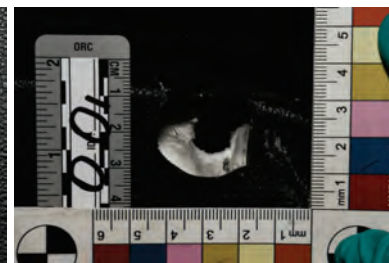
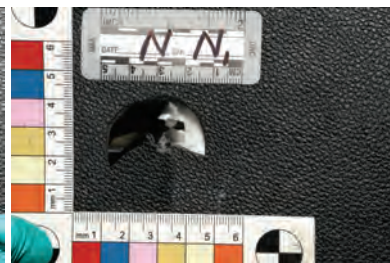
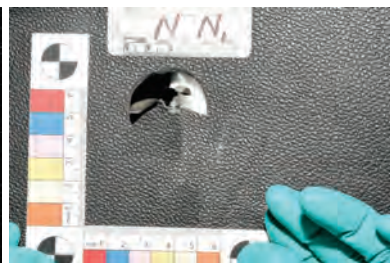

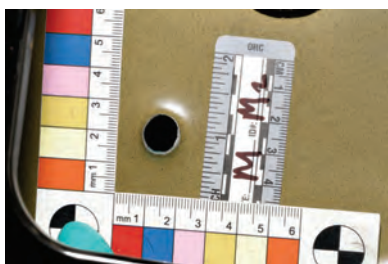
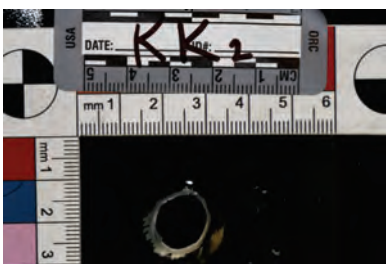
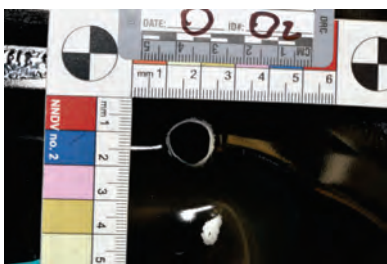

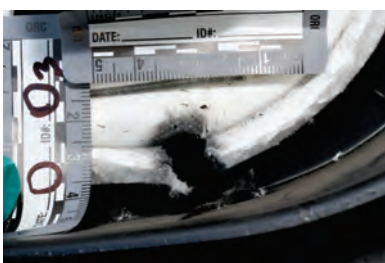
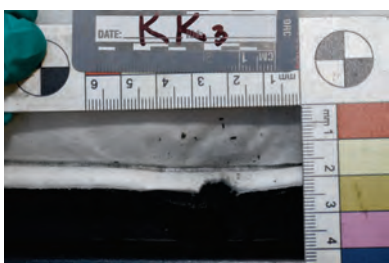
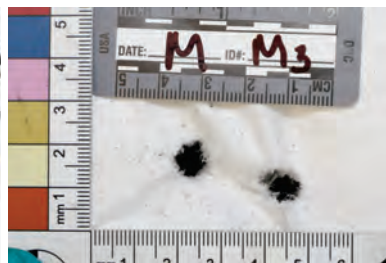

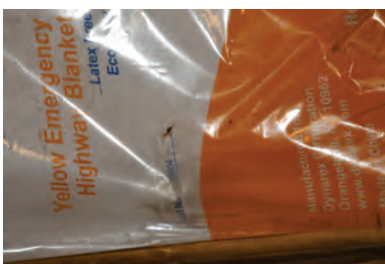
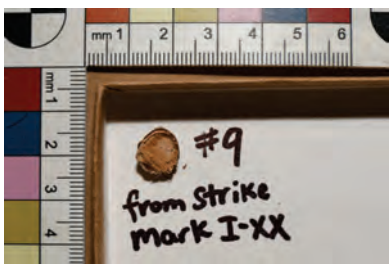
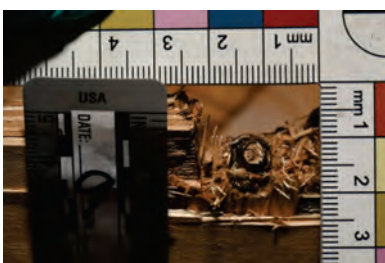
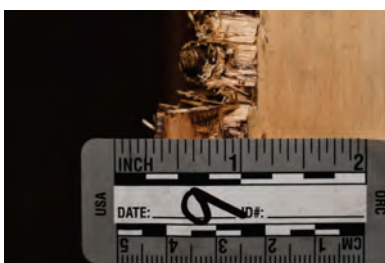
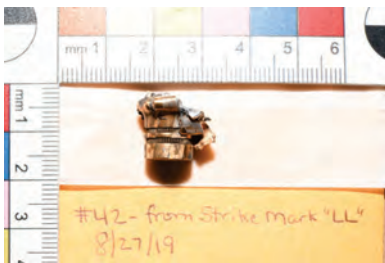
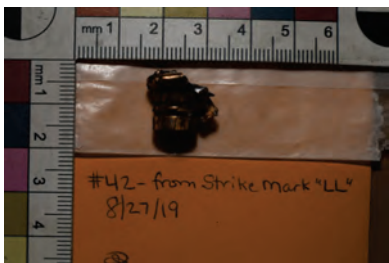

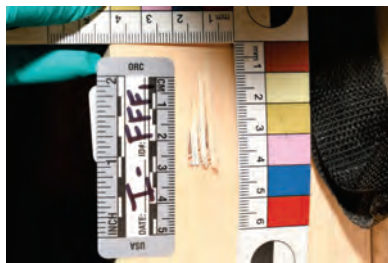

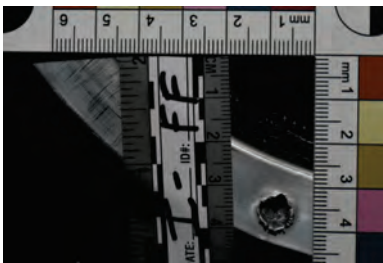
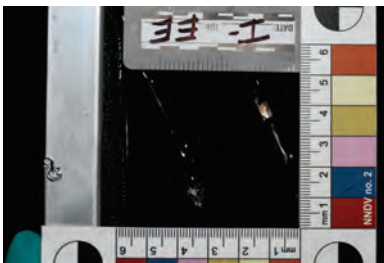
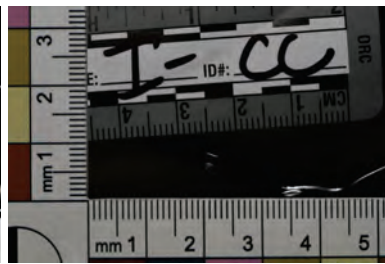
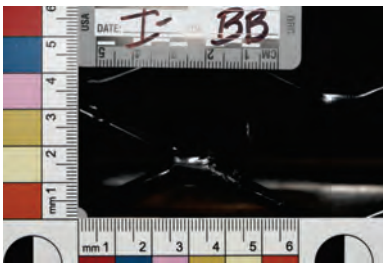
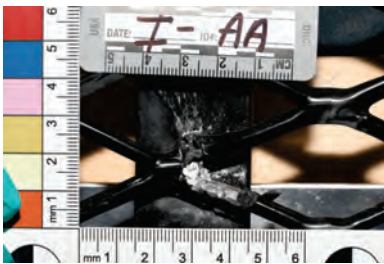
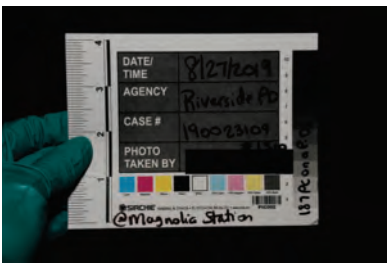
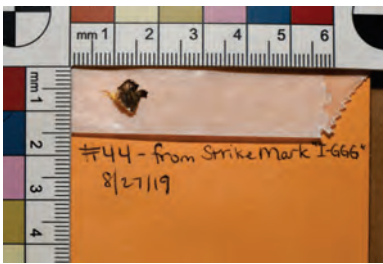
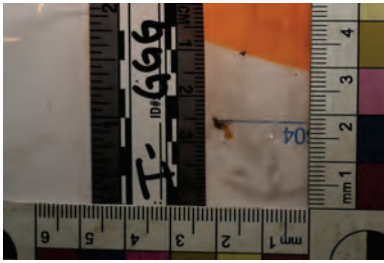

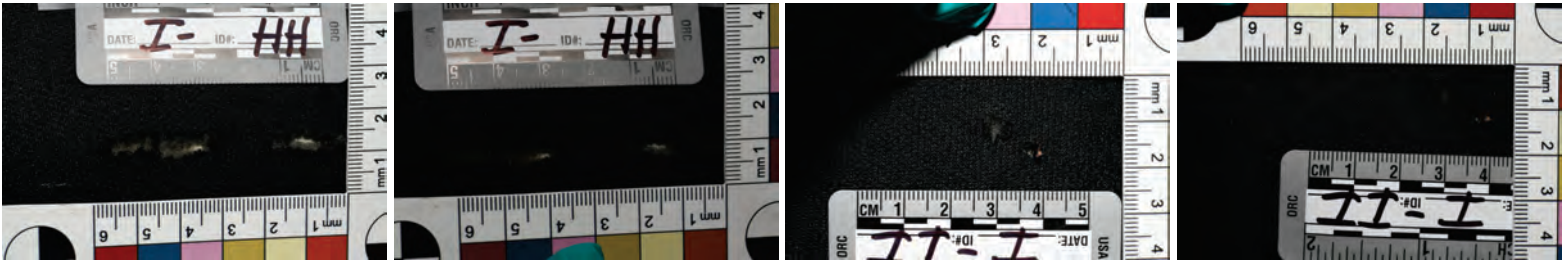

1910023109
0/29/19
OIS/1187PC RED

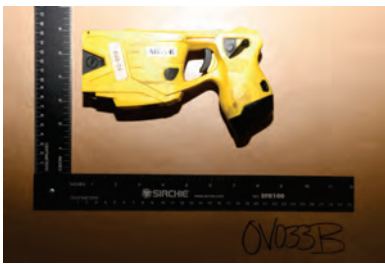

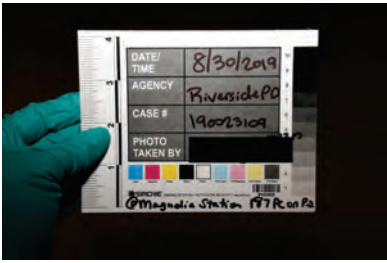

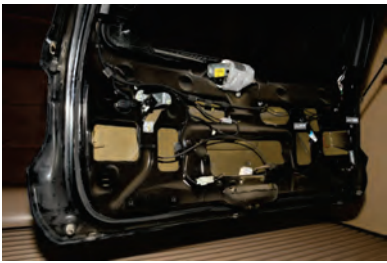
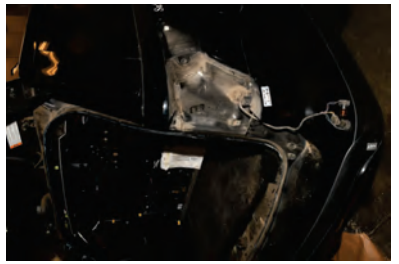



DATE 8/29/2019
TIME 1:55 PM
AGENCY Riverside PD
CASE # 190023109
PHOTOGRAPHER [signature]
@MagnumStation

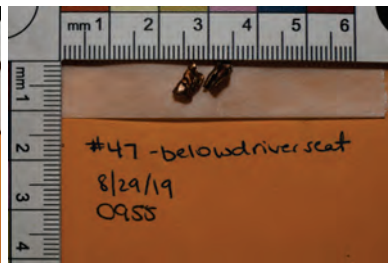
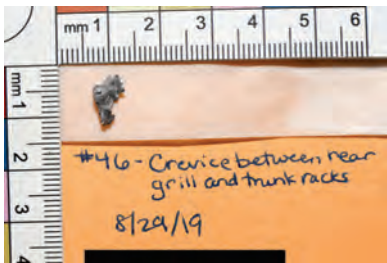
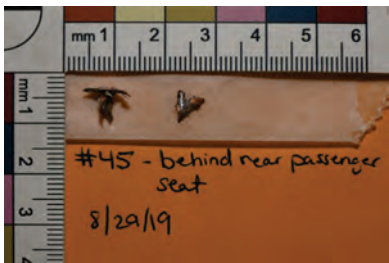
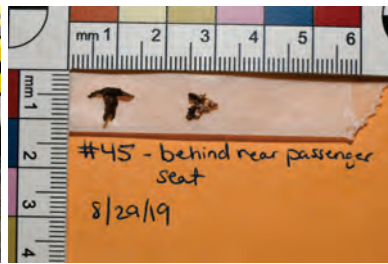

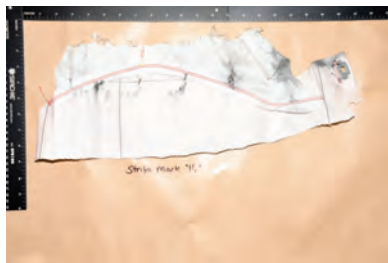
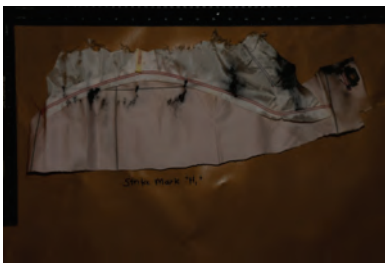
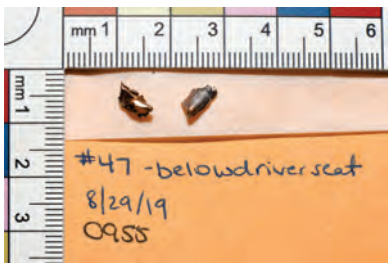

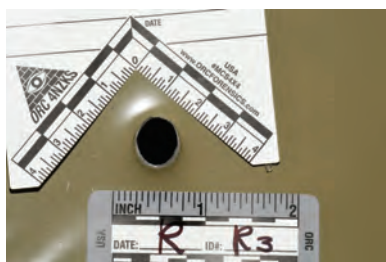
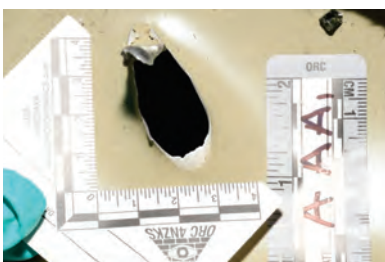
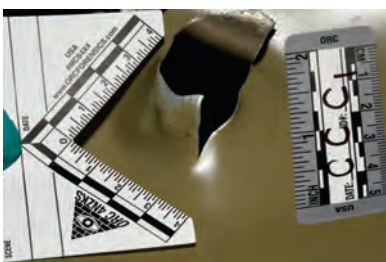
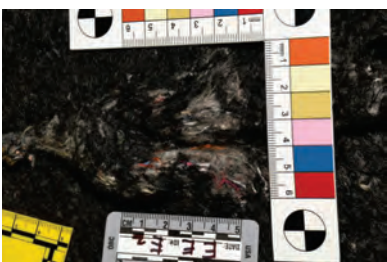
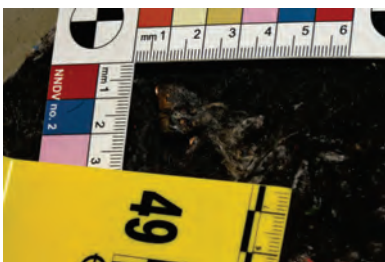
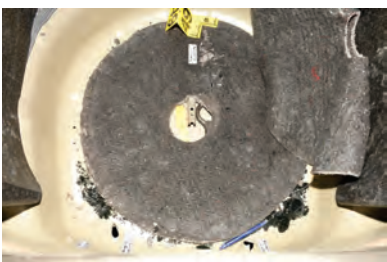
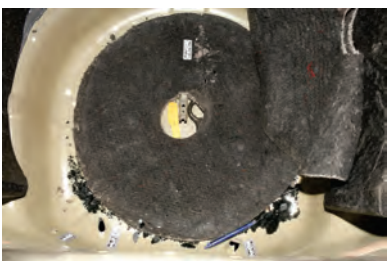
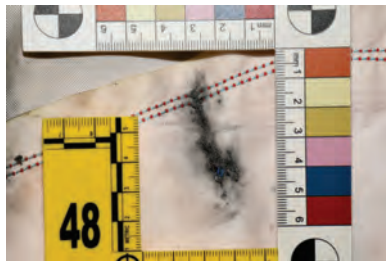

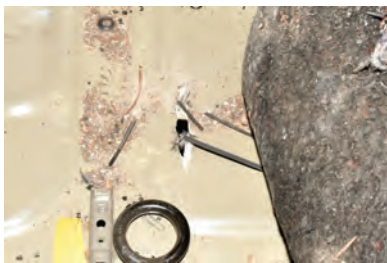
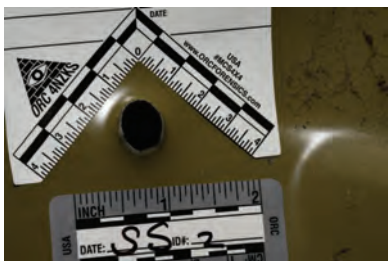

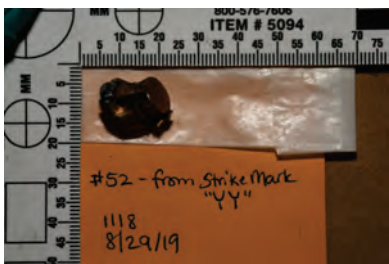
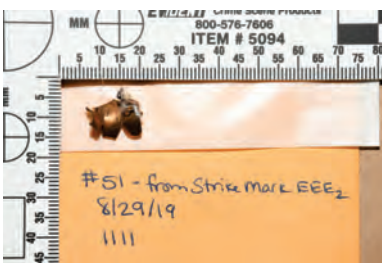
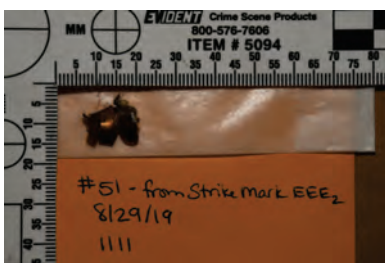
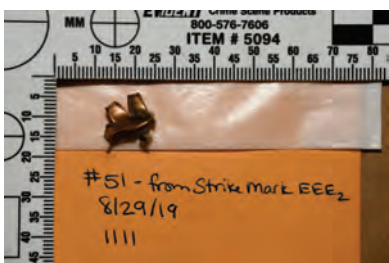
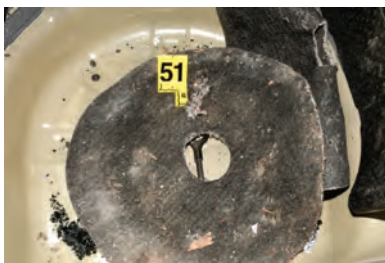

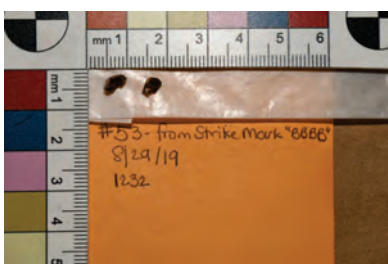
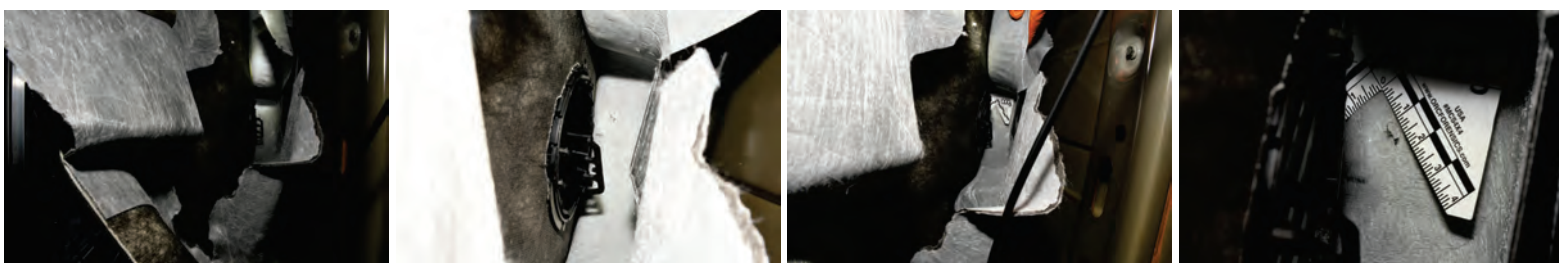
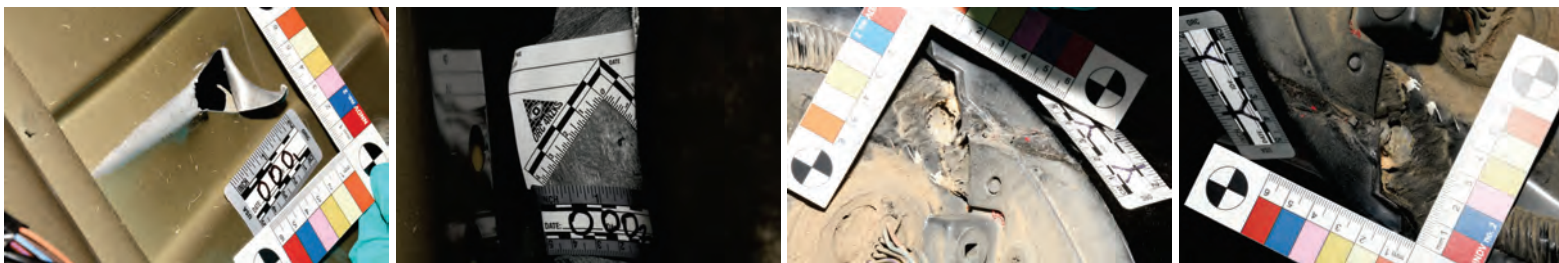

Spare
Tire



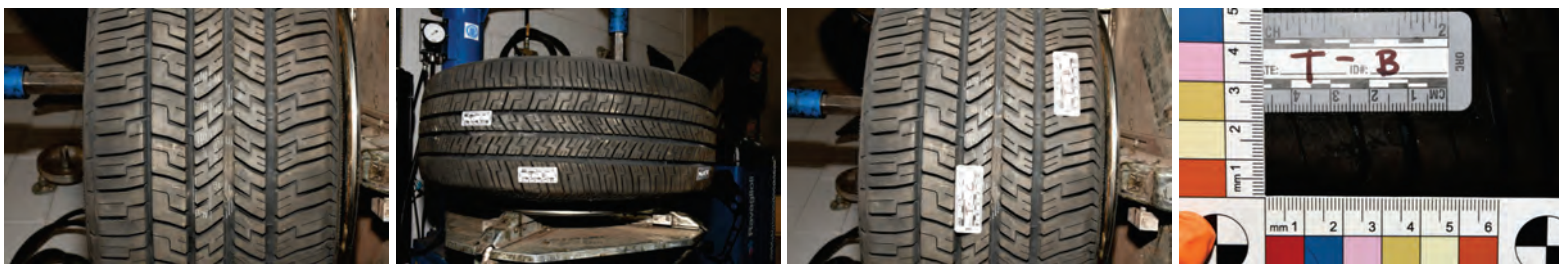
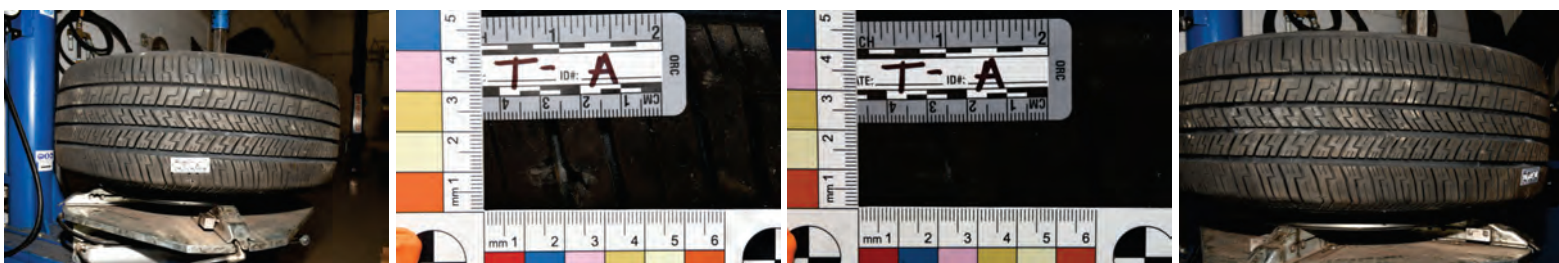

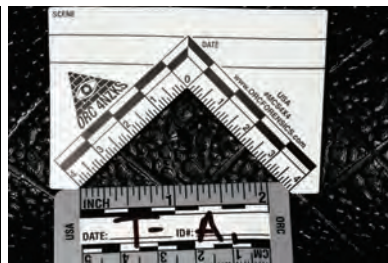
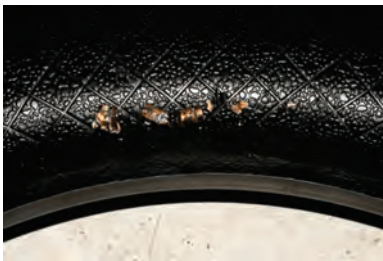
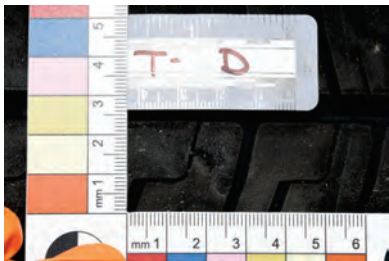



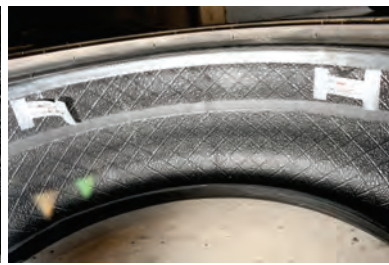
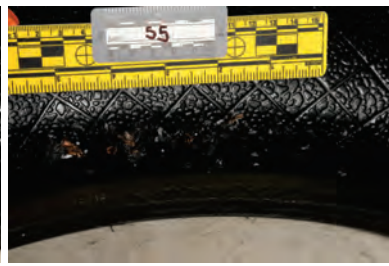
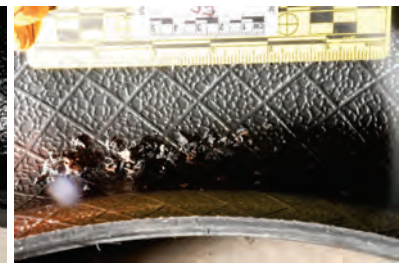



Passenger
Front

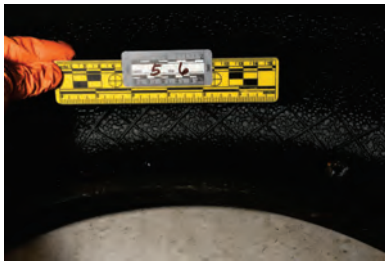
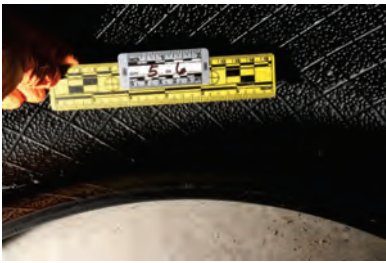
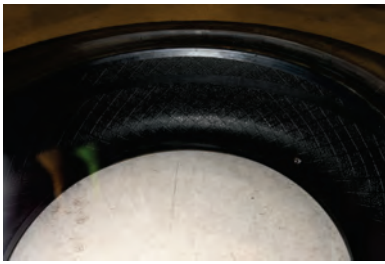
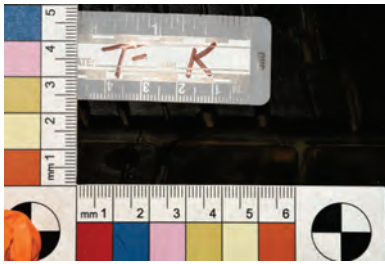

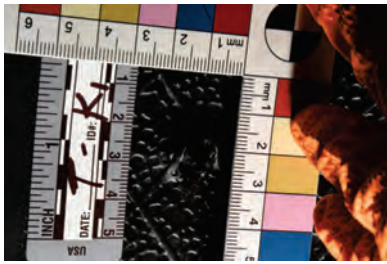
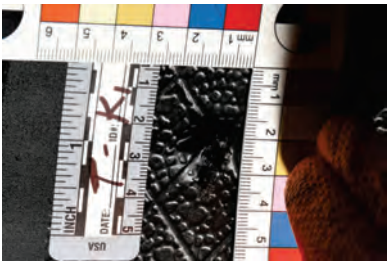



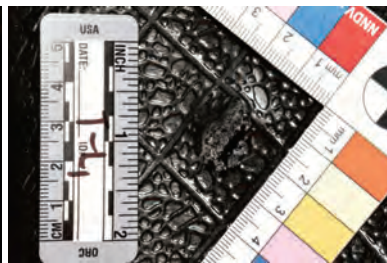
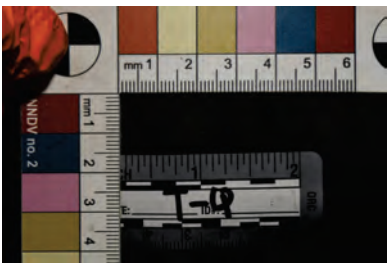

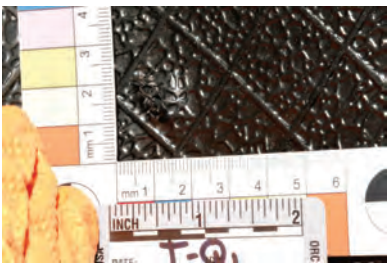
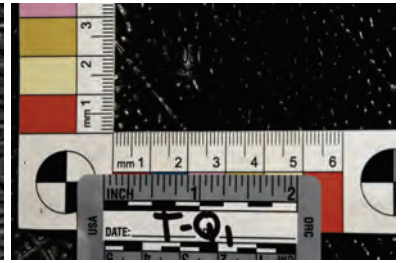
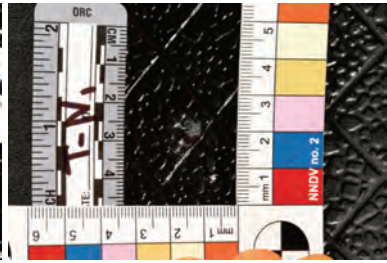
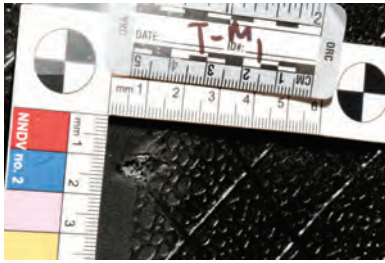
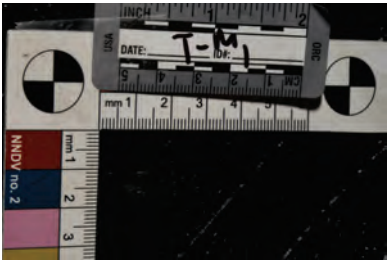

Passenger Rear

DRIVER
REAR



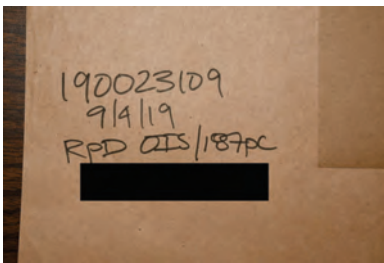
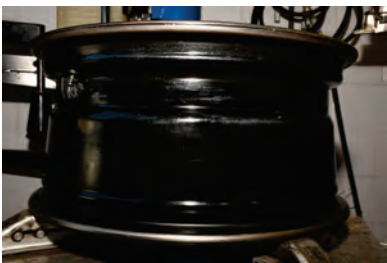
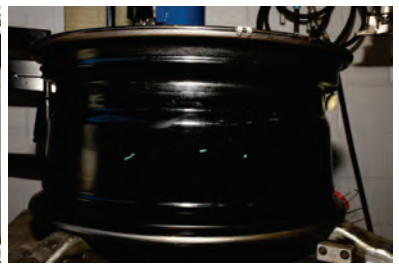

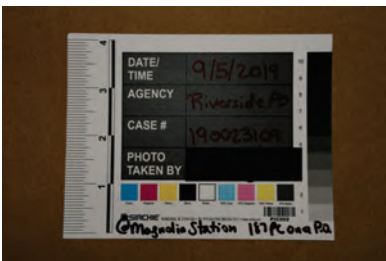
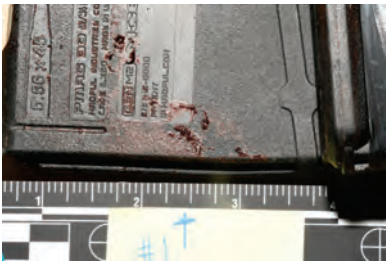
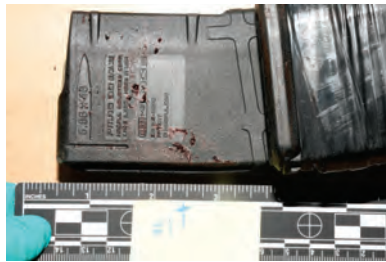



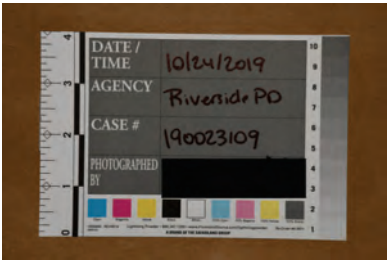



City of Arts & Innovation

PRESS RELEASE

Police Department
SERGIO G. DIAZ
Chief of Police

FOR IMMEDIATE RELEASE

August 16, 2019

CONTACT:
Officer Ryan J. Railsback
Public Information Officer
Community Services Bureau
railsback@riversideca.gov
(951) 373-6032 (Media Contact)

MURDER INVESTIGATION OF CALIFORNIA HIGHWAY PATROL OFFICER ANDRE MOYE JR.

RIVERSIDE, CA – On Monday, August 12, 2019, at approximately 5:37 p.m., a call for immediate assistance for an “officer down” was requested by the California Highway Patrol (CHP) on the Eastridge Avenue overpass at the 215 Freeway. Officers from the Riverside Police Department (RPD), University of California – Riverside Police Department (UCRPD), and Deputies from the Riverside County Sheriff’s Department (RSD) responded along with additional CHP Officers.

CHP Motor Officer Andre Moye Jr. conducted a traffic enforcement stop of a white pickup at this location. During that stop, the lone suspect produced a weapon and fired at Officer Moye Jr., severely injuring him. A backup CHP Officer, who was also on scene, immediately took gunfire from the suspect and returned fire. He called for assistance during the gunfight and was also struck, which caused a critical injury to one of his legs. Additional CHP Officers and RSD Deputies responded. Upon arrival, they also took gunfire from the suspect, but were able to move the backup CHP officer from the line of fire. The exchange of gunfire between the suspect and law enforcement continued for several minutes, resulting in a third CHP Officer being struck. A RPD Officer arrived to the west of the suspect and exchanged gunfire with him. The suspect was severely injured causing him to stop his attack.



Officers rendered aid to the three CHP Officers who sustained gunshots, along with the suspect. Two of the injured Officers were transported by police vehicle to the Riverside University Health Systems (RUHS) trauma center. Officer Moye Jr. was airlifted to the same hospital by RPD's police helicopter. Life-saving measures were made by RUHS staff but unfortunately, Officer Moye Jr. succumbed to his injuries and died in the line of duty. Officer Moye Jr. was a 4-year veteran assigned to the CHP – Riverside area station. One CHP Officer sustained minor injuries and was released the next day, and the other CHP Officer sustained critical injuries, but is currently in stable condition.

The suspect was taken to RUHS where he succumbed to his injuries. The weapon he used in this murder was a semi-automatic rifle, and it was recovered at the scene on the suspect. He was identified as Aaron Luther, 49-years-old of Beaumont. His criminal history includes prior prison commitment for attempted murder and assault with a deadly weapon against a peace officer, along with other violent crimes.

This critical incident occurred within the city limits of Riverside. The Riverside Police Department is the lead investigating agency. Detectives with the Robbery – Homicide Unit, along with Specialists from the Forensics Unit, responded and assumed the investigation. They were assisted by Detectives from the RSD's Central Homicide Unit and the CHP's Investigative Services Unit. The Riverside County Sheriff – Coroner and Riverside County District Attorney's Office are also assisting.

Peer support and counseling services have been offered for all law enforcement involved in this investigation. The Riverside University Health Systems has offered behavioral health services to any witness or non-law enforcement victim from this incident. For more information, please contact Roderick W. Verbeck at rverbeck@ruhealth.org or (951) 955-1551.

This investigation will be lengthy and no further details are available at this time. Anyone with additional information or video is urged to contact Detective Dan Mercadefe at (951) 353-7103 or dmercadefe@riversideca.gov, or Detective Brett Stennett at (951) 353-7213 or bstennett@riversideca.gov.

ALL MEDIA INQUIRIES should be directed to our Public Information Officer at (951) 373-6032 or rrailsback@riversideca.gov.

To view the two press conferences regarding this investigation, click on:
[Joint Press Conference - Monday, August 12, 2019](#)
[Joint Press Conference - Tuesday, August 13, 2019](#)

A memorial account has been created for the family of Officer Andre Moye Jr. through the California Association of Highway Patrolmen (CAHP) Credit Union.

Donations can be made online at:

<https://cahpcu.org/OfficerAndreMoyeJrMemorialFund>

or mailed to:

CAHP Credit Union
P.O. Box 276507
Sacramento, CA 95826.

Condolences may be sent to the following address:

California Highway Patrol, Riverside Area
8118 Lincoln Ave.
Riverside, CA 92504

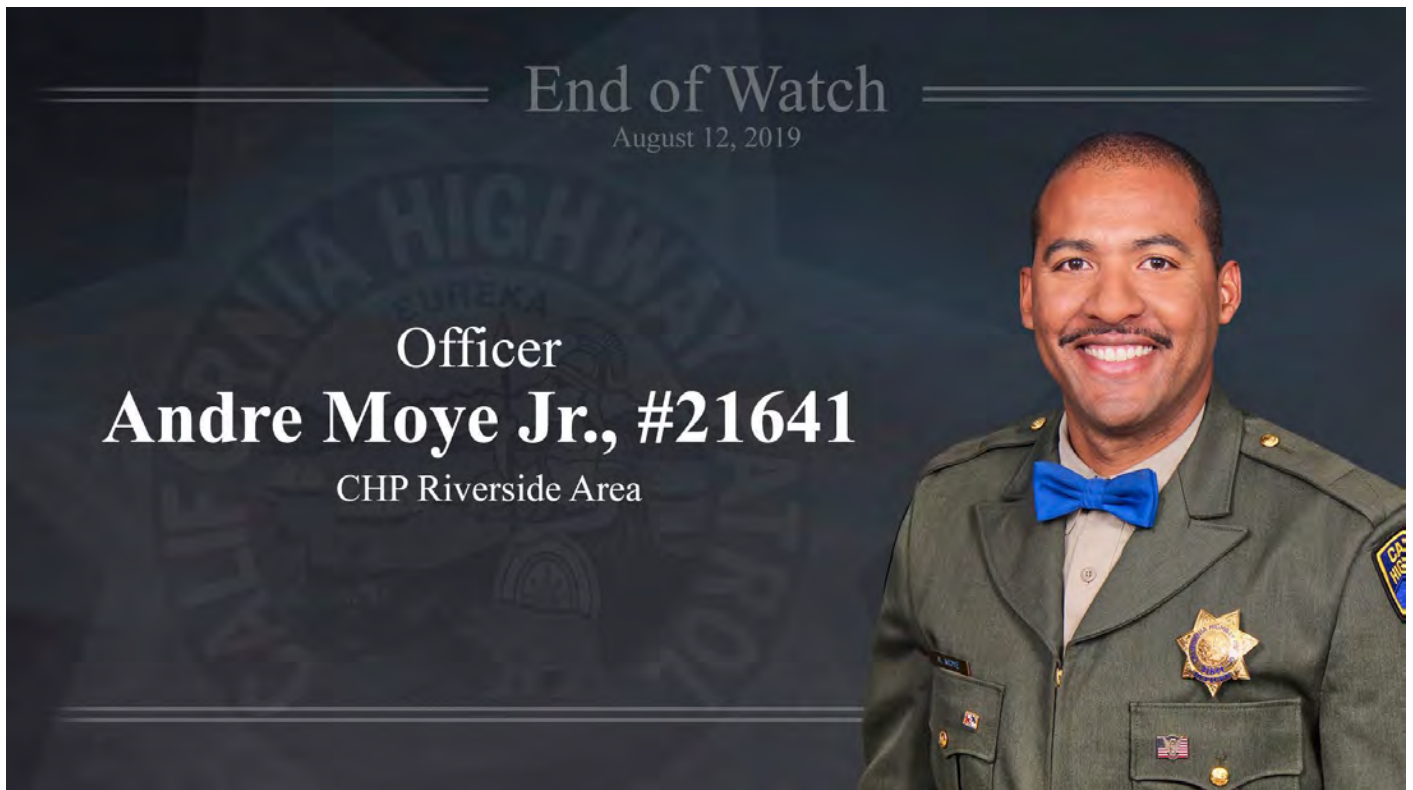

190023109



OFFICE OF
THE DISTRICT ATTORNEY
COUNTY OF RIVERSIDE

MICHAEL A. HESTRIN
DISTRICT ATTORNEY

August 18, 2021

Larry Gonzalez, Chief
Riverside Police Department
4102 Orange Street
Riverside, CA 92501

Dear Chief Gonzalez:

Subject: Officer Kevin Feimer, ID #419
Agency Report #190023109

Please be advised that our office has completed its review of the incident involving the above-mentioned officer from your department. After careful review, we have concluded that there is no evidence of criminal liability on the officer's part.

If you have any questions, please do not hesitate to contact me.

Very truly yours,

MICHAEL A. HESTRIN
District Attorney

MAH:mrg



OFFICE OF
THE DISTRICT ATTORNEY
COUNTY OF RIVERSIDE

MICHAEL A. HESTRIN
DISTRICT ATTORNEY

August 18, 2021

Chad Bianco, Sheriff
Riverside County Sheriff's Department
4095 Lemon Street, 2nd Floor
Riverside, CA 92501

Dear Sheriff Bianco:

Subject: Deputy Dustin Goetz, ID #4688
Agency Report #190023109

Please be advised that our office has completed its review of the incident involving the above-mentioned deputy from your department. After careful review, we have concluded that there is no evidence of criminal liability on the deputy's part.

If you have any questions, please do not hesitate to contact me.

Very truly yours,

A handwritten signature in blue ink, appearing to read "Michael A. Hestrin".

MICHAEL A. HESTRIN
District Attorney

MAH:mrg



OFFICE OF
THE DISTRICT ATTORNEY
COUNTY OF RIVERSIDE

MICHAEL A. HESTRIN
DISTRICT ATTORNEY

August 18, 2021

Chad Bianco, Sheriff
Riverside County Sheriff's Department
4095 Lemon Street, 2nd Floor
Riverside, CA 92501

Dear Sheriff Bianco:

Subject: Deputy Mario Chavez, ID #3211
Agency Report #190023109

Please be advised that our office has completed its review of the incident involving the above-mentioned deputy from your department. After careful review, we have concluded that there is no evidence of criminal liability on the deputy's part.

If you have any questions, please do not hesitate to contact me.

Very truly yours,

A handwritten signature in black ink, appearing to read "Michael A. Hestrin". The signature is fluid and cursive.

MICHAEL A. HESTRIN
District Attorney

MAH:mrg



OFFICE OF
THE DISTRICT ATTORNEY
COUNTY OF RIVERSIDE

MICHAEL A. HESTRIN
DISTRICT ATTORNEY

August 18, 2021

Chad Bianco, Sheriff
Riverside County Sheriff's Department
4095 Lemon Street, 2nd Floor
Riverside, CA 92501

Dear Sheriff Bianco:

Subject: Deputy Bryan Esparza, ID #236377
Agency Report #190023109

Please be advised that our office has completed its review of the incident involving the above-mentioned deputy from your department. After careful review, we have concluded that there is no evidence of criminal liability on the deputy's part.

If you have any questions, please do not hesitate to contact me.

Very truly yours,

MICHAEL A. HESTRIN
District Attorney

MAH:mrg



OFFICE OF
THE DISTRICT ATTORNEY
COUNTY OF RIVERSIDE

MICHAEL A. HESTRIN
DISTRICT ATTORNEY

August 18, 2021

Daniel J. Minor, Chief
California Highway Patrol
Inland Division
847 E. Brier Drive
San Bernardino, CA 92408

Dear Chief Minor:

Subject: Officer Robert Paul, ID #20945
Agency Report #190023109

Please be advised that our office has completed its review of the incident involving the above-mentioned officer from your department. After careful review, we have concluded that there is no evidence of criminal liability on the officer's part.

If you have any questions, please do not hesitate to contact me.

Very truly yours,

MICHAEL A. HESTRIN
District Attorney

MAH:mrg



OFFICE OF
THE DISTRICT ATTORNEY
COUNTY OF RIVERSIDE

MICHAEL A. HESTRIN
DISTRICT ATTORNEY

August 18, 2021

Daniel J. Minor, Chief
California Highway Patrol
Inland Division
847 E. Brier Drive
San Bernardino, CA 92408

Dear Chief Minor:

Subject: Officer Ryan Smith, ID #20668
Agency Report #190023109

Please be advised that our office has completed its review of the incident involving the above-mentioned officer from your department. After careful review, we have concluded that there is no evidence of criminal liability on the officer's part.

If you have any questions, please do not hesitate to contact me.

Very truly yours,

MICHAEL A. HESTRIN
District Attorney

MAH:mrg



MICHAEL A. HESTRIN
DISTRICT ATTORNEY

OFFICE OF
THE DISTRICT ATTORNEY
COUNTY OF RIVERSIDE

August 18, 2021

Daniel J. Minor, Chief
California Highway Patrol
Inland Division
847 E. Brier Drive
San Bernardino, CA 92408

Dear Chief Minor:

Subject: Officer Vincent Mendoza, ID #17504
Agency Report #190023109

Please be advised that our office has completed its review of the incident involving the above-mentioned officer from your department. After careful review, we have concluded that there is no evidence of criminal liability on the officer's part.

If you have any questions, please do not hesitate to contact me.

Very truly yours,

A handwritten signature in black ink, appearing to read "Michael A. Hestrin".

MICHAEL A. HESTRIN
District Attorney

MAH:mrg

190023109 A. LUTHER

To view video and audio footage for
OID-190023109 A. Luther, please
submit a public records request to the
City Clerk's Office @
<https://www.riversideca.gov/cityclerk/>

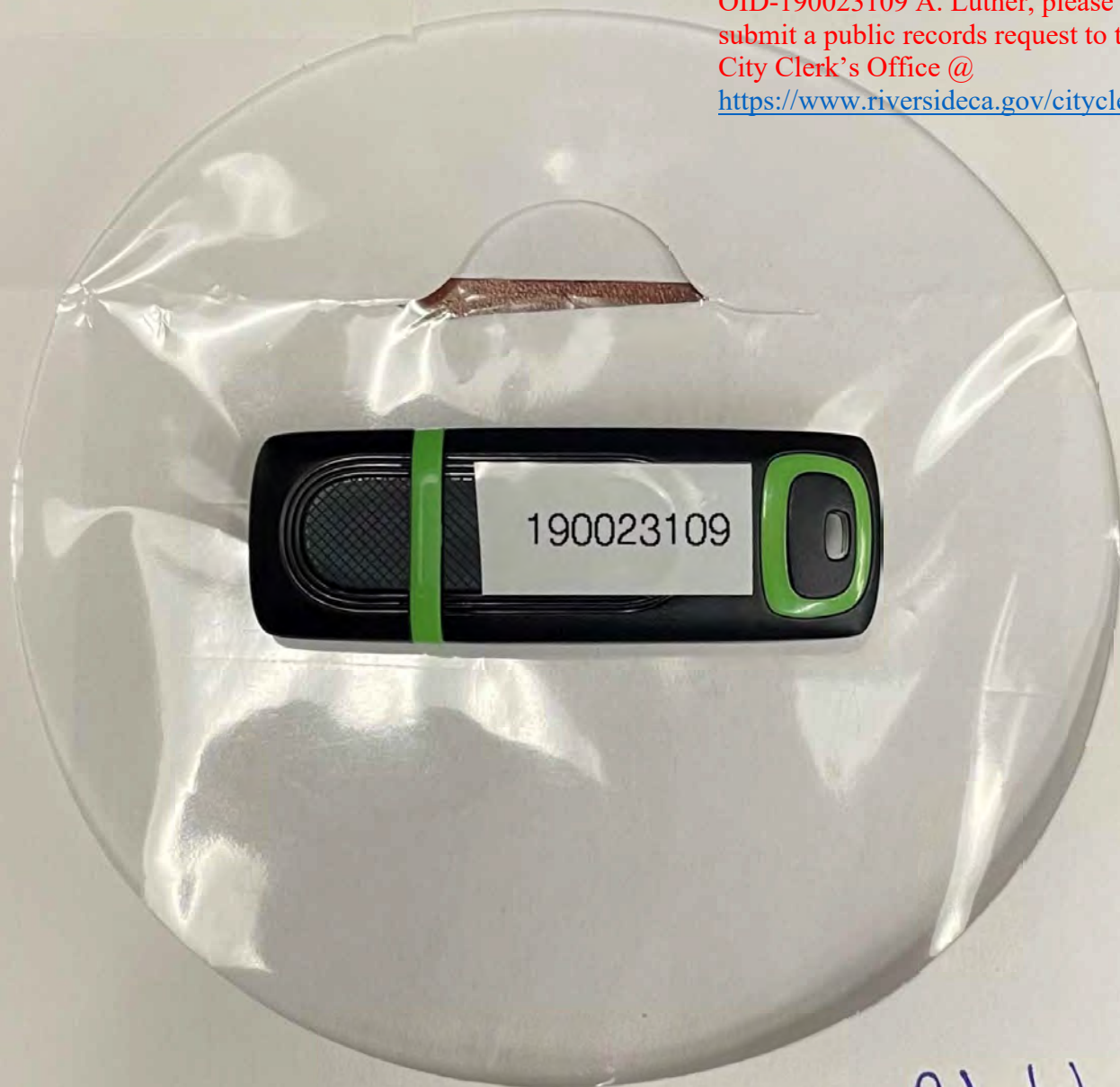

Redacted
PRA COPY