

*UPDATED PRELIMINARY GEOTECHNICAL EVALUATION
TENTATIVE TRACT 38921, PROPOSED 49-LOT RESIDENTIAL DEVELOPMENT
APPROXIMATELY 7-ACRE SITE LOCATED AT THE SOUTHEAST CORNER OF
LA SIERRA AND VICTORIA AVENUES, CITY OF RIVERSIDE, CALIFORNIA*

WARMINGTON RESIDENTIAL

*March 13, 2024
J.N. 23-341*

ENGINEERS + GEOLOGISTS + ENVIRONMENTAL SCIENTISTS

March 13, 2024
J.N. 23-341

WARMINGTON RESIDENTIAL

3090 Pullman Street
Costa Mesa, California 92626

Attention: Mr. Matthew Esquivel

Subject: Updated Preliminary Geotechnical Evaluation, Tentative Tract 38921, Proposed 49-Lot Residential Development, Approximately 7-Acre Site Located at the Southeast Corner of La Sierra and Victoria Avenues, City of Riverside, California

Dear Mr. Esquivel:

In accordance with your request and authorization, **Petra Geosciences, Inc. (Petra)** is submitting this preliminary geotechnical investigation report for the proposed residential development in the city of Riverside, California. This work was performed in general accordance with the scope of work outlined in our proposal dated February 12, 2024.

The purposes of our investigation were to obtain supplemental geotechnical and geologic information on the nature of current site soil conditions, to evaluate the potential geologic constraints that may affect development of the property, and to provide recommendations pertaining to site remedial grading and construction of anticipated site improvements. This report presents the results of our supplemental field exploration, limited laboratory testing, engineering judgment, opinions, conclusions and recommendations pertaining to geotechnical design aspects for the presumed site development. The development will primarily consist of graded pads for lightly-loaded residential structures and ancillary improvements.

It has been a pleasure to be of service to you on this project. Should you have questions regarding the contents of this report or should you require additional information, please contact the undersigned.

Respectfully submitted,

PETRA GEOSCIENCES, INC.



Douglass Johnston, CEG
Senior Associate Geologist, Vice President

TABLE OF CONTENTS

	<u>Page</u>
INTRODUCTION	1
SCOPE OF WORK	1
LOCATION AND SITE DESCRIPTION	2
PROPOSED DEVELOPMENT	2
Literature and Aerial Photo Review	3
Field Exploration and Testing	3
Laboratory Testing	4
FINDINGS	4
Regional Geologic Setting	4
Local Geology and Subsurface Soil Conditions	5
Groundwater.....	6
Faulting	6
Secondary Seismic Effects	6
Liquefaction and Seismically-Induced Settlement	7
Updated Liquefaction/Dynamic Settlement Potential	7
Compressible Soils.....	7
CONCLUSIONS AND RECOMMENDATIONS	8
Development Feasibility	8
Seismic Shaking	8
Remedial Grading	8
Earthwork Recommendations	8
General Recommendations	8
Geotechnical Observations and Testing	9
Demolition, Clearing and Grubbing	9
Geotechnical Observations.....	9
Unsuitable Soil Removals and Bottom Processing	10
Boundary Conditions	10
Cut-Fill Transition Areas	11
Benching	11
Suitability of On-Site Materials for Use as Engineered Fill.....	11
Excavation Characteristics	11
Fill Placement	11
Temporary Excavations.....	12
Import Soils for Grading	12
Volumetric Changes - Shrinkage and Subsidence.....	12
Fill Slope Construction	13
Cut Slope Construction	13
Tentative Preliminary Foundation Design Recommendations.....	13
Seismic Design Parameters	13
Foundation System.....	16
Allowable Soil Bearing Capacities.....	16
Estimated Footing Settlement	16
Lateral Resistance	17
Guidelines for Footings and Slabs on-Grade Design and Construction	17
Conventional Slabs on-Grade System	18
Foundation Excavation Observations.....	20
General Corrosivity Screening.....	20
Post-Grading Considerations	22
Precise Grading and Drainage.....	22

TABLE OF CONTENTS

	<u>Page</u>
Utility Trenches.....	23
Retaining Wall Design Recommendations	23
Footing Embedment.....	24
Allowable Soil Bearing Capacities.....	24
Lateral Resistance	24
Active Earth Pressures	24
Earthquake Loads on Retaining Walls	25
Masonry Screen Walls	25
Construction on or Near the Tops of Descending Slopes.....	25
Construction on Level Ground.....	25
Construction Joints.....	25
Tentative Pavement Design Recommendations.....	26
Preliminary Infiltration Rates.....	26
Shallow Infiltration Test Results.....	26
GRADING PLAN REVIEW	27
REPORT LIMITATIONS	27
REFERENCES	29

ATTACHMENTS

FIGURE 1 – SITE LOCATION MAP

FIGURE 2 – GEOTECHNICAL EXPLORATION MAP

APPENDIX A – FIELD EXPLORATION LOGS (PETRA AND 2014 SEC)

APPENDIX B – LABORATORY TEST PROCEDURES / LABORATORY DATA SUMMARY (PETRA AND 2014 SEC)

APPENDIX C – SEISMIC AND LIQUEFACTION PARAMETERS

APPENDIX D – STANDARD GRADING SPECIFICATIONS

**UPDATED PRELIMINARY GEOTECHNICAL EVALUATION
TENTATIVE TRACT 38921, PROPOSED 49-LOT RESIDENTIAL DEVELOPMENT
APPROXIMATELY 7-ACRE SITE LOCATED AT THE SOUTHEAST CORNER OF LA
SIERRA AND VICTORIA AVENUES CITY OF RIVERSIDE, CALIFORNIA**

INTRODUCTION

Petra Geosciences, Inc. (Petra) is presenting herein the results of our supplemental geotechnical investigation for the proposed residential development of approximately 7-acres of vacant land situated southeasterly of La Sierra and Victoria Avenues, in the city of Riverside, California. The purpose of this study was to obtain supplemental information on the general geologic and geotechnical soil conditions within the project area in order to provide conclusions and recommendations for the feasibility of the proposed project, and preliminary geotechnical recommendations for site grading and improvements. Our geotechnical evaluation included a review of the previous geotechnical report by Soil Exploration Company, Inc. (SEC, 2014), geological maps and data for the site and surrounding area, drilling four exploratory borings, performing additional laboratory testing, and pertinent geologic and engineering analysis.

SCOPE OF WORK

The scope of our evaluation consisted of the following.

- Review of the available published geotechnical report for the site, as well as regional maps and data, concerning geologic and soil conditions within the site and nearby area, that could have an impact on the proposed development.
- Review readily available historical photographs and online aerial imagery of the site and surrounding area.
- Coordinate with the local underground utility locating service (i.e., Underground Service Alert [USA]) to obtain an underground-utility clearance, prior to commencement of the subsurface exploration.
- Geotechnical drilling, logging, and sampling of four (4) supplemental exploratory soil borings utilizing a trac-mounted hollow-stem auger drill rig. Log and visually classify soil and materials encountered in our borings in accordance with the Unified Soil Classification System (USCS).
- Conduct supplemental laboratory testing of representative samples (bulk and undisturbed) obtained from the borings to determine their engineering properties.
- Engineering and geologic analysis of the research, field exploration findings and laboratory data with respect to the proposed site development.
- Preparation of this geotechnical report presenting the results of our evaluation and providing recommendations for the proposed site development in general conformance with the requirements of the 2022 California Building Code (2022 CBC), as well as in accordance with applicable state and local jurisdictional requirements.

LOCATION AND SITE DESCRIPTION

The subject property is essentially square-shaped and approximately 8.8-acres in size, of which 7.0 acres are proposed for development. The site is situated south/southeasterly of Victoria Avenue, west/southwesterly of Millsweet Place and east/northeasterly of La Sierra Avenue. Existing residences are located to the southeast. The site is currently utilized as an orange grove with the exception of the eastern quadrant that appears to have been more recently developed as a park or recreational features. Site access is at a driveway at the end of Millsweet Place, although a locked gate is also present off Victoria Avenue. Wire and/or chain link fencing surrounds the site.

The vast majority of the site is covered by an active orange grove with other miscellaneous mature trees located in other areas. The southeasterly quadrant also been partially improved with an asphalt driveway, a few sheds and miscellaneous playground-related equipment. These recreation facilities no longer appear to be in use; however, several contractor trailers and vehicles were currently parked within the site. A windmill structure is present near the center of the site along with overhead power poles for electricity. Overhead power lines are also located near the southwestern property line along La Sierra Avenue and at least one power pole leads to the windmill.

Underground irrigation lines are expected to be present throughout the property and although not observed, a water well and electrical conduit may also be present. Two electric vaults were observed at the south corner. The southeastern property edge appears to have undergone some form of undocumented grading as evidenced by a noteworthy break in grade, is clear of vegetation and a concrete-lined drainage swale is present near the property line. This grading likely took place during development of the residences to the south/southeast and may extend into the site by approximately 20 to 25 feet horizontally with fills on the order of 5± feet above original site grades.

In addition to the grove trees, site vegetation consists of a variable growth of weeds, grasses and shrubs. Miscellaneous debris was randomly observed on the surface of the site. The property is at a relatively low gradient, sloping gently to the northwest with site elevations ranging from approximately 839 feet above mean sea level (msl) at the southeastern corner to approximately 820 feet msl at the northwestern corner.

PROPOSED DEVELOPMENT

Based the architectural concept plan, Option 3j prepared by ktgy Architecture + Planning and the Tentative Tract map No. 38921 prepared by Adkan Engineers, the planned development will consist of approximately 49 new residential lots and appurtenant interior streets and alleyways. Ancillary site improvements will include underground utilities, asphalt or concrete pavements for interior streets and alleyways, perimeter

walls, an infiltration basin and landscaping. A new sewer line will connect the development to an existing offsite manhole on Victoria Avenue past Millsweet Place. A 4- to 6-foot high retaining wall is proposed along the southeasterly property line, at the rear of proposed Lots 1-13, where these lots expected to be 4 to 6 feet lower than the adjacent property. The new tract entrance will near the southwestern corner at La Sierra Avenue.

Although grading plans are not currently available, the presumed grading may entail cuts and fills on the order of 3 to 7 feet from existing grades. Cut and or fill slopes are anticipated to be constructed at 2:1 (h:v) gradients.

Literature and Aerial Photo Review

In addition to the prior geotechnical report prepared by SEC (2014), Petra also researched and reviewed available published and unpublished geologic data pertaining to regional geology, faulting and geologic hazards that may affect the site. The results of this review are included within this report, see references.

Readily available online aerial imagery was reviewed to assess previous land use. The subject site appears to have been utilized as an orange grove since at least 1931. Victoria and La Sierra Avenues were also present since that time and the surrounding properties were developed for residential use during the 1980's which may have included some fill placement along the southeastern property line. The grove operations have continued from at least 1931 to the present time with the exception of the southeasterly quadrant of the site. During 2002, portions of the grove in this local area was cleared and some localized construction appeared to be taking place by 2004. By 2007 a park and/or recreational facility included an asphalt-paved driveway and several sheds had been constructed. This area appears to no longer be in active use, with the exception of parking for contractor vehicles/trailers.

Field Exploration and Testing

A subsurface exploration program was conducted under the supervision of an engineering geologist from Petra on February 29, 2024. Subsurface exploration involved the drilling and sampling of four (4) exploratory borings, designated B-1 through B-4, to depths of 20 to 21.5 feet below existing site grade. Drilling was performed with a track-mounted drill rig equipped with 6-inch outside diameter, hollow-stem augers. Earth materials encountered within the exploratory borings were classified and logged in accordance with the visual-manual procedures of the Unified Soil Classification System (USCS). The approximate locations of the exploratory borings are shown on the attached Geotechnical Exploration Map, Figure 2 and descriptive logs of the borings are presented in Appendix A. The pertinent 2014 SEC boring locations and logs are also shown on Figure 2 and presented in Appendix A.

Subsurface exploration also included the collection of bulk samples and relatively undisturbed samples of soil materials for classification, laboratory testing and geotechnical engineering analyses. Bulk samples consisted of selected soil materials obtained from the exploratory borings. Relatively undisturbed samples were obtained using a 3-inch outside diameter modified California split-spoon soil sampler lined with brass rings. The soil samples were mechanically driven to a depth of 18 inches with successive 30-inch drops of a 140-pound automatic trip hammer and the number of blows required to drive the sampler for each 6-inch increment inches are noted in the boring logs in Appendix A. The driven core samples were placed in sealed containers and transported to Petra's laboratory for laboratory testing.

Standard Penetration Tests (SPT) were also performed at selected depth intervals in accordance with ASTM D1586. This method consists of mechanically driving an unlined, 2.0-inch outside diameter (OD) standard penetrometer split-barrel sampler 18 inches into the soil with successive 30-inch drops of the 140-pound automatic trip hammer. Blow counts are also noted on the exploration logs. Disturbed soil samples from the unlined standard split-spoon samplers were placed in sealed plastic bags and transported to our laboratory for testing.

Laboratory Testing

Laboratory testing for selected samples of onsite soils materials included in-situ dry density and moisture content, expansion index, shear strength parameters (direct and remolded) and general soil corrosion potential (sulfate content, chloride content, pH/resistivity). A description of laboratory test methods and test data are presented in Appendix B and the results of in-situ moisture content and dry density tests are summarized in the boring logs presented in Appendix A. The limited 2014 SEC soil laboratory data is also presented in Appendix B.

FINDINGS

Regional Geologic Setting

Geologically, the site lies near the northern portion of the Peninsular Ranges Geomorphic Province of California (CGS, 2002). The Peninsular Range Province extends from the tip of Baja California north to the Transverse Ranges Geomorphic Province and is characterized by northwest trending mountain ranges separated by subparallel fault zones. The San Bernardino Mountains, located on the north side of the valley, provides the boundary between the Peninsula Range Province and the Transverse Ranges Province. In general, the province is underlain primarily of plutonic rock of the Southern California Batholith. These rocks formed from the cooling of molten magma deep within the earth's crust. Intense heat associated with

the plutonic magma metamorphosed the ancient sedimentary rocks into which the plutons intruded. The Peninsular Range Geomorphic Province is generally characterized by alluviated basins and elevated erosional surfaces.

Local Geology and Subsurface Soil Conditions

The geologic map of the Riverside West quadrangle (Morton & Cox, 2001) depict the subject property situated near the proximal portion of an old alluvial fan deposit of the late to middle Pleistocene era descending from the northern flanks of Arlington Mountain. This local mountain range consists primarily of granodiorite and gabbrotic bedrock. The site is also situated between two northwest trending drainages dissecting the fan and is also located about 1,000 feet southwest of the concrete-lined Riverside Canal. Based on the prior and our current borings, the site is mantled by a young alluvial unit overlying the older alluvial fan deposits. The underlying granitic bedrock is at an unknown depth. A general description of the soil units encountered are provided below.

Undocumented Artificial Fill – Artificial fill is present within the site along the southeasterly property line likely associated with prior grading of the residential properties to the southeast. These fill soils predominately consist of moist and soft sandy silt, with a minor occurrence of loose silty sand that appear to be between approximately 4 to 7 feet in thickness. Due to the past site usage, shallow fills estimated to be on the order of 1 to 2 feet in thickness may be encountered within other areas of the grove.

Young Alluvium – Young alluvium was observed beneath the fills in our boings and is interpreted to mantle the upper portions of the site based on the 2014 SEC borings. These soils generally consist of sandy silts with occasional interbeds of silty sand. These materials were generally moist and soft to firm in the upper several feet and stiff or medium dense at approximately 8 to 9 feet in depth and below. The young alluvium extended to depths between approximately 16 to 20 feet below grade at our 4 borings and based on the 2014 SEC logs, is likely 13 to 15 feet in approximate thickness in other portions of the site.

Old Alluvial Fan Deposits – Old Alluvial Fan deposits of middle to late Pleistocene age were observed beneath the young alluvium across the site. Generally, these soils consist of slightly moist, sandy silt, that was hard to very hard, with slight cementation and encountered at approximate depth of 16 to 20 feet below surface grades along the southeastern site edge. The bedrock description on the 2014 SEC logs is very likely this same older alluvial fan unit, encountered at approximately 15 to 20 feet below grade.

Groundwater

Groundwater was not encountered within our borings drilled to a maximum depth of 21.5 feet below the ground surface (bgs), nor from the prior 2014 SEC borings advanced to a maximum of 25 feet bgs. Free groundwater is not expected to be encountered during remedial grading at the present time. However, historic high groundwater level in the nearby area was estimated at 10± feet bgs and was also observed at approximately 5± feet bgs in a nearby well during 1974 (SEC, 2014).

Based on our research within the nearby area and current subsurface conditions, groundwater is not anticipated to affect the proposed development; however, as with any development, there is the possibility of localized perched water and minor seepage may occur in fill layers of differing permeability once site landscaping is installed and irrigation implemented.

Faulting

Based on our review of published and unpublished geotechnical maps and literature pertaining to site geology, no active or potentially active faults are known to project through the site and the site does not lie within the bounds of an “Earthquake Fault Zone” as defined by the State of California in the Alquist-Priolo (AP) Earthquake Fault Hazard Zoning Act (Bryant and Hart, 2007). In addition, the site does not lie with a fault zone established by Riverside County. Our review shows the closest known active earthquake fault is the Elsinore Fault zone which lies approximately 7.1 miles (11.4 kilometers) to the southwest. The potential for active fault rupture at the site is considered to be remote.

Secondary Seismic Effects

Secondary effects of seismic activity normally considered as possible hazards to a site include several types of ground failure. Various general types of ground failures, which might occur as a consequence of severe ground shaking at the site, include landsliding, ground subsidence, ground lurching and lateral spreading. The probability of occurrence of each type of ground failure depends on the severity of the earthquake, distance from faults, topography, subsoil and groundwater conditions, in addition to other factors. The subject property proposed for development exhibits near-level topography that is not prone to landsliding, and the potential for ground lurching and lateral spreading are considered very low. The potential for seismically-induced flooding due to tsunami or seiche (i.e., a wave-like oscillation of the surface of water in an enclosed basin) is considered negligible at this site.

Liquefaction and Seismically-Induced Settlement

Liquefaction occurs when dynamic loading of a saturated sand or silt causes pore-water pressures to increase to levels where grain-to-grain contact is lost, and the material temporarily behaves as a viscous fluid. Liquefaction can cause settlement of the ground surface, settlement and tilting of engineered structures, flotation of buoyant buried structures and fissuring of the ground surface. A common manifestation of liquefaction is the formation of sand boils, which are short-lived fountains of soil and water that emerge from fissures or vents and leave freshly deposited conical mounds of sand or silt on the ground surface.

Riverside County has identified located the subject property area within a moderate to high liquefaction susceptibility zone. Based on the lack of shallow groundwater encountered and the hard to very hard nature of the older alluvial fan deposits and granitic bedrock further underlying the site, the potential for manifestation of liquefaction and for seismic (i.e., dynamic) settlement, in the form of dry sand settlement, are expected to be very low. However, the County has indicated a moderate to high potential for liquefaction in the nearby area. Accordingly, Petra has performed updated dynamic settlement analyses using the data provided in 2014 SEC report to determine the settlement potential of the loose near-surface soils in accordance with 2022 CBC requirements within the site.

Updated Liquefaction/Dynamic Settlement Potential

Seismically Induced Settlement

Petra has reanalyzed the boring data with respect to potential for liquefaction and dry sand settlement within the site development. The analysis was performed following the guidelines contained in Special Publication 117A published by the California Geological Survey (1997, Revised 2008) and those in the 2022 California Building Code (2022 CBC). Based on the updated analysis, seismically induced settlement within the site is calculated to be on the order of 1 to 1 ½ inches under the very unlikely scenario of high groundwater returning to a level of 5 feet below ground surface.

Based on our calculations, the differential settlement between various locations within the site is not expected to exceed 1 inch in 40 feet, which is considered well within tolerable limits for seismic differential settlement. See Appendix C.

Compressible Soils

A geotechnical factor affecting the project site is the presence of shallow topsoil, undocumented fill and loose or soft, near-surface young alluvium. Such materials in their present state are not considered suitable

for support of fill or structural loads. Based on our borings and the data on the 2014 SEC borings logs, the existing soils including all topsoils and the upper portions of low-density alluvial deposits, are deemed to be moderately to highly compressible. Accordingly, these materials will require removal to competent alluvial deposits as observed by the geotechnical consultant and replacement as properly moisture-conditioned and compacted fill. The removed soils may be use as engineered (compacted) fill.

CONCLUSIONS AND RECOMMENDATIONS

Development Feasibility

Based on our supplemental field exploration, prior geotechnical data, research and review of pertinent geologic literature, and preliminary laboratory testing, development of the project site is considered feasible for the proposed residential development from a geotechnical standpoint. The following geotechnical factors should be considered during the design process.

Seismic Shaking

The site is located within an active tectonic area of southern California with several significant faults capable of producing moderate to strong earthquakes. The site will likely be subjected to very strong seismically related ground shaking during the anticipated life span of the project and structures within the site should therefore be designed and constructed to resist the effects of strong ground motion in accordance with the most current edition of the California Building Code, i.e. anticipated to be the 2022 CBC.

Remedial Grading

Near-surface soils are loose, or soft and inconsistent due to their variable nature and are subject to static settlement due to dead and live loading conditions of structures and consolidation. Accordingly, remedial grading of the upper portions of the alluvial soils will be necessary for support of shallow foundations and engineered fills. In general, all existing undocumented fill and near-surface compressible soils will need to be removed (over-excavated), to be placed as properly compacted fill.

Earthwork Recommendations

General Recommendations

Earthwork should be performed in accordance with the Grading Code of the City of Riverside, in addition to the applicable provisions of the 2022 CBC. Grading should also be performed in accordance with the following site-specific recommendations prepared by Petra based on the proposed construction including the Grading Specifications presented in Appendix D.

Geotechnical Observations and Testing

Prior to the start of earthwork, a meeting should be held at the site with the owner, contractor and geotechnical consultant to discuss the work schedule and geotechnical aspects of the grading. Earthwork, which in this instance will generally entail removal and re-compaction of loose existing soils to expose competent natural soils, should be accomplished under full-time observation and testing of the geotechnical consultant. A representative of the project geotechnical consultant should be present onsite during all earthwork operations to document proper placement and compaction of fills, as well as to document compliance with the other recommendations presented herein.

Demolition, Clearing and Grubbing

All existing structures, the windmill, power poles, pavements, water/irrigation pipes and/or any storm drain lines will need to be demolished and removed from the site as well as any other existing utility lines from the proposed grading areas. Following demolition, all existing trees and vegetation within areas to be graded should be stripped and removed from the site. Clearing operations should also include the removal of any remaining irrigation pipes, trash, debris, vegetation and similar deleterious materials. Any cavities or excavations created upon removal of any unknown subsurface structure(s) should be cleared of loose soil, shaped to provide access for backfilling and compaction equipment and then backfilled with properly compacted fill. Due to the presence of a grove, following removal of the tree root balls, any remaining roots may need to be removed by hand (i.e. root pickers), during grading operations.

The project geotechnical consultant should provide periodic observation and testing services during clearing and grubbing operations to document compliance with the above recommendations. In addition, should unusual or adverse soil conditions or buried structures be encountered during grading that are not described herein, these conditions should be brought to the immediate attention of the project geotechnical consultant for corrective recommendations.

Geotechnical Observations

Exposed bottom surfaces in remedial removal areas should be observed and approved by a representative of the project geotechnical consultant *prior to the placement of fill*. A representative of the project geotechnical consultant should also be present on site during major grading operations to document that proper placement and adequate compaction of fills has been achieved, as well as to observe compliance with the other recommendations presented herein. It is the grading contractor's responsibility to notify the

project geotechnical consultant at least 24 hours prior to requiring observation (including excavation bottom verification).

Unsuitable Soil Removals and Bottom Processing

Existing surficial undocumented fill and relatively shallow native alluvial soils are considered unsuitable for support of proposed fills, structures, flatwork, pavement or other improvements and should be removed to underlying competent alluvial materials as approved by the project geotechnical consultant. The estimated depth of removal of alluvial soils is recommended to be approximately 6 feet below the existing ground surface throughout the majority of the site, however, may be on the order of 7 to 8 feet below grade along the southeastern edge which where undocumented fills are present. Removals should also be no less than 2 feet below the bottom-of-footings. Soil removals may need to be locally deeper depending upon the exposed conditions encountered during grading. Soil removals in street or landscaped areas are anticipated to be on the order of 4 feet below existing grade or proposed grade, whichever is deeper.

Prior to placing engineered fill, the exposed bottom surfaces in the removal areas should be approved by a representative of project geotechnical consultant. The exposed removal bottoms should be scarified to a minimum depth of 12 inches, moisture-conditioned to achieve at least 2 percent above optimum moisture content and compacted with a heavy construction equipment prior to placement of fill. Minimum compaction of the upper 12 inches of the removal bottom should meet or exceed 90 percent relative compaction with reference to ASTM D 1557. The laboratory maximum dry density and optimum moisture content for each change in soil type should be determined in accordance with test method ASTM D 1557.

Boundary Conditions

Average remedial removals within the building pad areas of the subject site are anticipated to be on the order of 6 to 8 feet below the existing ground surface. Temporary backcut slopes adjacent to the tract boundaries should generally be restricted to a slope ratio of 1:1 (h:v) or flatter to protect adjacent offsite improvements (including pavement, sidewalks, walls, etc.) along the property boundaries. Unless encroachment to adjacent properties are secured, i.e. temporary offsite grading, depending on the actual horizontal extent of remedial grading that is achievable by the grading contractor, it is likely that a wedge of unsuitable soil will remain in place along the site perimeter that will extend into the site to a horizontal distance equal to as much as twice the depth of remedial removals. Since new perimeter wall improvements may be proposed within this zone, such improvements may need to be designed and constructed with deepened and/or strengthened foundation systems designed to withstand relative movement that is likely to result from settlement of these likely compressible surficial soils. The use of temporary shoring or slot cut

techniques along perimeter of the site is highly recommended. For conditions where remedial grading encroachment to adjacent sites cannot be secured i.e. temporary offsite grading, recommendations for design of temporary shoring, slot cut width, and design of property line walls will be provided under a separate cover when boundary wall plans become available.

Cut-Fill Transition Areas

Cut/fill transitions should be eliminated from beneath the building pad areas to reduce the detrimental effects of differential settlement. This should be accomplished by over-excavating the cut and shallow fill portions and replacing the excavated materials as properly compacted fill to at least 3 feet below pad grade. Horizontal limits of over-excavation should extend across the entire level portion of the lot.

Benching

Fills placed on or against sloping surfaces inclining at 5:1 (h:v) or steeper, should be placed on a series of level benches excavated into competent older alluvium. These benches should be provided at vertical intervals of approximately 3 to 4 feet. Typical benching details are shown on Plates SG-2, SG-5, SG-6, SG-7 and SG-8 (Appendix D).

Suitability of On-Site Materials for Use as Engineered Fill

Based on our field observations and subsurface soil conditions encountered in our borings, the on-site soil materials would be suitable for use as engineered fill provided they are clean of organics, construction debris or other deleterious materials. As with most remedial grading, the majority of soils exposed at or near the surface would require moisture-conditioning to near optimum moisture for use as engineered fill.

Excavation Characteristics

The existing site soils are expected to be readily excavated with conventional earthmoving equipment.

Fill Placement

Fill materials should be placed in approximately 6- to 8-inch thick loose lifts, watered or air-dried as necessary to achieve a moisture content of at least above optimum moisture condition, and then compacted in-place to a minimum relative compaction of no less than 90 percent. The laboratory maximum dry density and optimum moisture content for each change in soil type should be determined in accordance with ASTM D 1557.

Temporary Excavations

Temporary excavations varying up to a height of 6± feet below existing grades may be required to accommodate the recommended over-excavation of existing soft/loose alluvial soils. Based on the physical properties of the onsite soils, temporary excavations which are constructed exceeding 4 feet in height should be cut back to a ratio of 1:1 (h:v) or flatter for the duration of the over-excavation of unsuitable soil material and replacement as compacted fill, as well as placement of underground utilities. The temporary excavations should be observed by a representative of the project geotechnical consultant for evidence of potential instability. Depending on the results of these observations, revised slope configurations may be necessary. Other factors which should be considered with respect to the stability of the temporary slopes include construction traffic and/or storage of materials on or near the tops of the slopes, construction scheduling, presence of nearby walls or structures on adjacent properties and weather conditions at the time of construction. Applicable requirements of the California Construction and General Industry Safety Orders, the Occupational Safety and Health act of 1970 and the Construction Safety Act should also be followed.

Import Soils for Grading

If import soils are needed to achieve final design grades the soils should be free of deleterious materials, oversize rock and any hazardous materials. The soils should also be non-expansive and essentially non-corrosive and approved by the project geotechnical consultant *prior* to being brought onsite. The geotechnical consultant should visit the potential borrow site and conduct testing of the soil at least three days before the commencement of import operations.

Volumetric Changes - Shrinkage and Subsidence

Volumetric changes in earth quantities will occur when onsite soils are excavated and replaced as properly compacted fill. Based on in-place densities of earth materials encountered during our evaluation, a shrinkage factor on the order of 15± percent may be anticipated during removal and recompaction. The actual shrinkage that will occur during grading will depend on the average degree of relative compaction achieved. A maximum subsidence of approximately 0.10 to 0.20 feet may be anticipated as a result of the scarification and recompaction of the exposed bottom surfaces within the removal areas.

The above estimates of shrinkage and subsidence are intended for use by project planners in estimating earthwork quantities and should not be considered absolute values. Contingencies should be made for balancing earthwork quantities based on actual shrinkage and subsidence that will occur during site grading.

Fill Slope Construction

A fill key excavated at a depth of 2 feet or more into competent alluvium is recommended at the base of all new fill slopes 5 feet in height or higher. The width of the fill key should equal one-half the slope height or 15 feet, whichever is greater. Typical fill-key construction details are shown on Plates SG-2, SG-5, SG-6 and SG-8 (Appendix D). To obtain proper compaction to the face of low-height fill slopes should be overfilled during construction and then trimmed-back to the compacted inner core.

The finish surface of the low-height fill slopes are anticipated to be both grossly and surficially stable at an inclination of 2:1 (h:v); however, these slopes may be potentially erodible.

Cut Slope Construction

Based on the grading plans, the site appears to be entirely in fill to achieve design grades, therefore cut slopes are not currently anticipated.

Tentative Preliminary Foundation Design Recommendations

Seismic Design Parameters

Earthquake loads on earthen structures and buildings are a function of ground acceleration which may be determined from the site-specific ground motion analysis. Alternatively, a design response spectrum can be developed for certain sites based on code guidelines. We used two computer applications to provide the design team with the parameters necessary to construct the design acceleration response spectrum for this project. The United States Geological Survey (USGS) Unified Hazard Tool website, <https://earthquake.usgs.gov/hazards/interactive/>, is used to estimate the earthquake magnitude and the distance to surface projection of the fault. The Structural Engineering Association of California (SEA) and California's Office of Statewide Health Planning and Development (OSHPD), SEA/OSHPD, Seismic Design Maps Tool website, <https://seismicmaps.org>, is used to calculate ground motion parameters.

To run the applications discussed above, a knowledge of site latitude and longitude; seismic risk category; and site class is required. The site class designation depends on the direct or indirect measurement of average small-strain shear wave velocity, V_{s30} , within the upper 30 meters (approximately 100 feet) of the site soils.

A seismic risk category of II was assigned to the proposed buildings in accordance with 2022 CBC, Table 1604.5. Shear wave velocity measurements were not specifically performed at the site; however, based on the soil sampler blow counts in Boring B-4, the site exhibits the characteristics of a stiff/dense soil and soft rock condition, therefore, in accordance with ASCE 7-16, Table 20.3-1, a Site Class D-Stiff designation is assigned. As such, Table 1 below provides parameters required to construct the seismic response coefficient, C_s , curve based on ASCE 7-16, Article 12.8 guidelines. The V_{s30} calculations and website printouts are provided in Appendix C.

~Remainder of Page Intentionally Left Blank~

TABLE 1
Seismic Design Parameters

Ground Motion Parameters	Specific Reference	Parameter Value	Unit
Site Latitude (North)	-	33.8875	°
Site Longitude (West)	-	-117.4618	°
Site Class Definition	Section 1613.2.2 ⁽¹⁾ , Chapter 20 ⁽²⁾	D-Stiff ⁽⁴⁾	-
Assumed Seismic Risk Category	Table 1604.5 ⁽¹⁾	II	-
M _w - Earthquake Magnitude	USGS Unified Hazard Tool ⁽³⁾	6.5 ⁽³⁾	-
R – Distance to Surface Projection of Fault	USGS Unified Hazard Tool ⁽³⁾	11.4 ⁽³⁾	km
S _s - Mapped Spectral Response Acceleration Short Period (0.2 second)	Figure 1613.2.1(1) ⁽¹⁾	1.5 ⁽⁴⁾	g
S ₁ - Mapped Spectral Response Acceleration Long Period (1.0 second)	Figure 1613.2.1(3) ⁽¹⁾	0.597 ⁽⁴⁾	g
F _a – Short Period (0.2 second) Site Coefficient	Table 1613.2.3(1) ⁽¹⁾	1 ⁽⁴⁾	-
F _v – Long Period (1.0 second) Site Coefficient	Table 1613.2.3(2) ⁽¹⁾	null ⁽⁴⁾	-
S _{M5} – MCE _R Spectral Response Acceleration Parameter Adjusted for Site Class Effect (0.2 second)	Equation 16-20 ⁽¹⁾	1.5 ⁽⁴⁾	g
S _{M1} - MCE _R Spectral Response Acceleration Parameter Adjusted for Site Class Effect (1.0 second)	Equation 16-21 ⁽¹⁾	null ⁽⁴⁾	g
S _{DS} - Design Spectral Response Acceleration at 0.2-s	Equation 16-22 ⁽¹⁾	1 ⁽⁴⁾	g
S _{D1} - Design Spectral Response Acceleration at 1-s	Equation 16-23 ⁽¹⁾	null ⁽⁴⁾	g
T _o = 0.2 S _{D1} / S _{DS}	Section 11.4.6 ⁽²⁾	null	s
T _s = S _{D1} / S _{DS}	Section 11.4.6 ⁽²⁾	null	s
T _L - Long Period Transition Period	Figure 22-14 ⁽²⁾	8 ⁽⁴⁾	s
PGA - Peak Ground Acceleration Maximum Considered Earthquake Geometric Mean, MCE _G ^(*)	Figure 22-9 ⁽²⁾	0.571	g
F _{PGA} - Site Coefficient Adjusted for Site Class Effect ⁽²⁾	Table 11.8-1 ⁽²⁾	1.1 ⁽⁴⁾	-
PGAM – Peak Ground Acceleration ⁽²⁾ Adjusted for Site Class Effect	Equation 11.8-1 ⁽²⁾	0.628 ⁽⁴⁾	g
Design PGA ≈ (2/3 PGAM) - Slope Stability ^(†)	Similar to Eqs. 16-22 & 16-23 ⁽²⁾	0.42	g
Design PGA ≈ (0.4 S _{DS}) – Short Retaining Walls ^(‡)	Equation 11.4-5 ⁽²⁾	0.40	g
C _{RS} - Short Period Risk Coefficient	Figure 22-18A ⁽²⁾	0.94 ⁽⁴⁾	-
C _{R1} - Long Period Risk Coefficient	Figure 22-19A ⁽²⁾	0.92 ⁽⁴⁾	-
SDC - Seismic Design Category ^(§)	Section 1613.2.5 ⁽¹⁾	null ⁽⁴⁾	-
References:			
⁽¹⁾ California Building Code (CBC), 2022, California Code of Regulations, Title 24, Part 2, Volume I and II.			
⁽²⁾ American Society of Civil Engineers/Structural Engineering Institute (ASCE/SEI), 2016, Minimum Design Loads and Associated Criteria for Buildings and Other Structures, Standards 7-16.			
⁽³⁾ USGS Unified Hazard Tool - https://earthquake.usgs.gov/hazards/interactive/ [Dynamic: Conterminous U.S. 2014 (update) (v4.2.0)]			
⁽⁴⁾ SEI/OSHPD Seismic Design Map Application – https://seismicmaps.org [Reference: ASCE 7-16]			
Related References:			
Federal Emergency Management Agency (FEMA), 2015, NEHERP (National Earthquake Hazards Reduction Program) Recommended Seismic Provision for New Building and Other Structures (FEMA P-1050).			
Notes:			
* PGA Calculated at the MCE return period of 2475 years (2 percent chance of exceedance in 50 years).			
† PGA Calculated at the Design Level of 2/3 of MCE; approximately equivalent to a return period of 475 years (10 percent chance of exceedance in 50 years).			
‡ PGA Calculated for short, stubby retaining walls with an infinitesimal (zero) fundamental period.			
§ The designation provided herein may be superseded by the structural engineer in accordance with Section 1613.2.5.1, if applicable.			

Foundation System

Based on the expectation that very low expansion potential soils will be present at finish pads grades following site grading, a conventional slab-on-ground foundation is recommended for the proposed residual buildings. This should be confirmed by additional testing at the completion of site grading.

Allowable Soil Bearing Capacities

Pad Footings

An allowable soil bearing capacity of 1,500 pounds per square foot may be utilized for design of isolated 24-inch-square footings founded at a minimum depth of 12 inches below the lowest adjacent final grade for pad footings that are not a part of the slab system and are used for support of such features as roof overhang, second-story decks, patio covers, etc. This value may be increased by 20 percent for each additional foot of depth and by 10 percent for each additional foot of width, to a maximum value of 2,500 pounds per square foot. The recommended allowable bearing value includes both dead and live loads, and may be increased by one-third for short duration wind and seismic forces.

Continuous Footings

An allowable soil bearing capacity of 1,500 pounds per square foot may be utilized for design of continuous footings founded at a minimum depth of 12 inches below the lowest adjacent final grade. This value may be increased by 20 percent for each additional foot of depth and by 10 percent for each additional foot of width, to a maximum value of 2,500 pounds per square foot. The recommended allowable bearing value includes both dead and live loads and may be increased by one-third for short duration wind and seismic forces.

For foundations to be located adjacent to property lines where complete removal and re-compaction of unsuitable surficial soil materials below the proposed foundations can be performed but the *horizontal* limits of remedial grading are restricted due to perimeter constraints, a maximum allowable bearing value of 1,200 pounds per square foot should be used. These conditions may affect foundations for retaining and landscape walls to be located along the tract boundaries if remedial grading cannot encroach into the adjacent properties. The need for special foundation design for these structures should be evaluated during grading based on the actual limits of remedial removals achieved by the grading contractor.

Estimated Footing Settlement

Based on the allowable bearing values provided above, total static settlement of the footings under the anticipated loads is expected to be less than $\frac{3}{4}$ inch. Differential settlement is expected to be less than $\frac{1}{2}$

inch over a horizontal span of 30 feet. The majority of settlement is likely to take place as footing loads are applied or shortly thereafter.

Lateral Resistance

A passive earth pressure increasing at a rate of 250 pounds per square foot per foot of depth, to a maximum value of 2,500 pounds per square foot, may be used to determine lateral bearing resistance for footings. In addition, a coefficient of friction of 0.40 times the dead load forces may be used between concrete and the supporting soils to determine lateral sliding resistance.

Lateral bearing and lateral sliding resistance may be combined without reduction. In addition, an increase of one-third of the above values may be used when designing for short duration wind and seismic forces.

The above values are based on footings placed directly against compacted fill. In the case where footing sides are formed, all backfill placed against the footings should be compacted to at least 90 percent of maximum dry density.

For foundations to be located adjacent to tract boundaries where complete removal and recompaction of unsuitable surficial soil materials *below* the proposed foundations can be performed but the *horizontal* limits of remedial grading are restricted due to perimeter constraints, a passive pressure of 150 pounds per square foot, per foot of depth, to a maximum value of 1,500 pounds per square foot, should be used to determine the lateral bearing.

Guidelines for Footings and Slabs on-Grade Design and Construction

Soils within the site are anticipated to exhibit expansion potential that is within the Very Low range (Expansion Index from 0 to 20). As indicated in Section 1803.5.3 of 2022 California Building Code (2022 CBC), these soils are considered non-expansive and, as such, the design of slabs on-grade is considered to be exempt from the procedures outlined in Sections 1808.6.2 of the 2022 CBC and may be performed using any method deemed rational and appropriate by the project structural engineer. However, the following minimum recommendations are presented herein for conditions where the project design team may require geotechnical engineering guidelines for design and construction of footings and slabs on-grade the project site.

The design and construction guidelines that follow are based on the above soil conditions and may be considered for reducing the effects of variability in fabric, composition and, therefore, the detrimental behavior of the site soils such as excessive short- and long-term total and differential

settlements. These guidelines have been developed on the basis of the previous experience of this firm on projects with similar soil conditions. Although construction performed in accordance with these guidelines has been found to reduce post-construction movement and/or distress, they generally do not positively eliminate all potential effects of variability in soils characteristics and future settlement.

It should also be noted that the suggestions for dimension and reinforcement provided herein are performance-based and intended only as preliminary guidelines to achieve adequate performance under the anticipated soil conditions. However, they should not be construed as replacement for structural engineering analyses, experience and judgment. The project structural engineer, architect and/or civil engineer should make appropriate adjustments to slab and footing dimensions, and reinforcement type, size and spacing to account for internal concrete forces (e.g., thermal, shrinkage and expansion), as well as external forces (e.g., applied loads) as deemed necessary. Consideration should also be given to minimum design criteria as dictated by local building code requirements.

Conventional Slabs on-Grade System

Given the very low expansion potential by onsite soils expected to be present at finish pad grades, we recommend that footings and floor slabs be designed and constructed in accordance with the following minimum criteria.

Footings

1. Exterior continuous footings supporting one- and two-story structures should be founded at a minimum depth of 12 inches below the lowest adjacent final grade, respectively. Interior continuous footings may be founded at a minimum depth of 10 inches below the top of the adjacent finish floor slabs.
2. In accordance with Table 1809.7 of 2022 CBC for light-frame construction, all continuous footings should have minimum widths of 12 inches for one- and two-story construction. We recommend all continuous footings should be reinforced with a minimum of two No. 4 bars, one top and one bottom.
3. A minimum 12-inch-wide grade beam founded at the same depth as adjacent footings should be provided across garage entrances or similar openings (such as large doors or bay windows). The grade beam should be reinforced with a similar manner as provided above.
4. Interior isolated pad footings, if required, should be a minimum of 24 inches square and founded at a minimum depth of 12 inches below the bottoms of the adjacent floor slabs. Pad footings should be reinforced with No. 4 bars spaced a maximum of 18 inches on centers, both ways, placed near the bottoms of the footings.

5. Exterior isolated pad footings intended for support of roof overhangs such as second-story decks, patio covers, and similar construction should be a minimum of 24 inches square and founded at a minimum depth of 18 inches below the lowest adjacent final grade. The pad footings should be reinforced with No. 4 bars spaced a maximum of 18 inches on centers, both ways, placed near the bottoms of the footings. Exterior isolated pad footings may need to be connected to adjacent pad and/or continuous footings via tie beams at the discretion of the project structural engineer.
6. The minimum footing dimensions and reinforcement recommended herein may be modified (increased or decreased subject to the constraints of Chapter 18 of the 2022 CBC) by the structural engineer responsible for foundation design based on his/her calculations, engineering experience and judgment.

Building Floor Slabs

1. Concrete floor slabs should be a minimum 4 inches thick and reinforced with No. 3 bars spaced a maximum of 24 inches on centers, both ways. Alternatively, the structural engineer may recommend the use of prefabricated welded wire mesh for slab reinforcement. For this condition, the welded wire mesh should be of sheet type (not rolled) and should consist of 6x6/W2.9xW2.9 (per the Wire Reinforcement Institute, WRI, designation) or stronger. All slab reinforcement should be supported on concrete chairs or brick to ensure the desired placement near mid-depth. Care should be exercised to prevent warping of the welded wire mesh between the chairs in order to ensure its placement at the desired mid-slab position.
2. Living area concrete floor slabs and areas to receive moisture sensitive floor covering should be underlain with a moisture vapor retarder consisting of a minimum 10-mil-thick polyethylene or polyolefin membrane that meets the minimum requirements of ASTM E96 and ASTM E1745 for vapor retarders (such as Husky Yellow Guard®, Stego® Wrap, or equivalent). All laps within the membrane should be sealed, and at least 2 inches of clean sand should be placed over the membrane to promote uniform curing of the concrete. To reduce the potential for punctures, the membrane should be placed on a pad surface that has been graded smooth without any sharp protrusions. If a smooth surface cannot be achieved by grading, consideration should be given to lowering the pad finished grade an additional inch and then placing a 1-inch-thick leveling course of sand across the pad surface prior to the placement of the membrane.

At the present time, some slab designers, geotechnical professionals and concrete experts view the sand layer below the slab (blotting sand) as a place for entrapment of excess moisture that could adversely impact moisture-sensitive floor coverings. As a preventive measure, the potential for moisture intrusion into the concrete slab could be reduced if the concrete is placed directly on the vapor retarder. However, if this sand layer is omitted, appropriate curing methods must be implemented to ensure that the concrete slab cures uniformly. A qualified materials engineer with experience in slab design and construction should provide recommendations for alternative methods of curing and supervise the construction process to ensure uniform slab curing. Additional steps would also need to be taken to prevent puncturing of the vapor retarder during concrete placement.

3. Garage floor slabs should be a minimum 4 inches thick and reinforced in a similar manner as living area floor slabs. Garage slabs should also be poured separately from adjacent wall footings with a positive separation maintained using ¾-inch-minimum felt expansion joint material. To control the propagation of shrinkage cracks, garage floor slabs should be quartered with weakened plane joints. Consideration should be given to placement of a moisture vapor retarder below the garage slab, similar

to that provided in Item 2 above, should the garage slab be overlain with moisture sensitive floor covering.

4. Presaturation of the subgrade below floor slabs will not be required; however, prior to placing concrete, the subgrade below all dwelling and garage floor slab areas should be thoroughly moistened to achieve a moisture content that is at least equal to or slightly greater than optimum moisture content. This moisture content should penetrate to a minimum depth of 12 inches below the bottoms of the slabs.
5. The minimum dimensions and reinforcement recommended herein for building floor slabs may be modified (increased or decreased subject to the constraints of Chapter 18 of the 2022 CBC) by the structural engineer responsible for foundation design based on his/her calculations, engineering experience and judgment.

Foundation Excavation Observations

Foundation excavations should be observed by a representative of this firm to document that they have been excavated into competent engineered fill soils prior to the placement of forms, reinforcement, or concrete. Following grading, the presence of sloughing in the compacted fill may require the use of forms when pouring concrete. The excavations should be trimmed neat, level and square. All loose, sloughed or moisture-softened soils and/or any construction debris should be removed prior to placing of concrete. Excavated soils derived from footing and/or utility trenches should not be placed in building slab-on-grade areas or exterior concrete flatwork areas unless the soils are compacted to at least 90 percent of maximum dry density.

General Corrosivity Screening

As a screening level study, limited chemical and electrical tests were performed on samples considered representative of the onsite soils to identify potential corrosive characteristics of these soils. The common indicators associated with soil corrosivity include water-soluble sulfate and chloride levels, pH (a measure of acidity), and minimum electrical resistivity.

It should be noted that Petra does not practice corrosion engineering; therefore, the test results, opinion and engineering judgment provided herein should be considered as general guidelines only. Additional analyses would be warranted, especially for cases where buried metallic building materials (such as copper and cast or ductile iron pipes) in contact with site soils are planned for the project. In many cases, the project geotechnical engineer may not be informed of these choices. Therefore, for conditions where such elements are considered, we recommend that other, relevant project design professionals (e.g., the architect, landscape architect, civil and/or structural engineer) also consider recommending a qualified corrosion engineer to conduct additional

sampling and testing of near-surface soils during the final stages of site grading to provide a complete assessment of soil corrosivity. Recommendations to mitigate the detrimental effects of corrosive soils on buried metallic and other building materials that may be exposed to corrosive soils should be provided by the corrosion engineer as deemed appropriate.

In general, a soil’s water-soluble sulfate levels and pH relate to the potential for concrete degradation; water-soluble chlorides in soils impact ferrous metals embedded or encased in concrete, e.g., reinforcing steel; and electrical resistivity is a measure of a soil’s corrosion potential to a variety of buried metals used in the building industry, such as copper tubing and cast or ductile iron pipes. Table 2, below, presents the range of each category of individual test results with an interpretation of current code indicators and guidelines that are commonly used in this industry. The table includes the code-related classifications of the soils as they relate to the various tests, as well as a general recommendation for possible mitigation measures in view of the potential adverse impact on various components of the proposed structures in direct contact with site soils. The guidelines provided herein should be evaluated and confirmed, or modified, in their entirety by the project structural engineer, corrosion engineer and/or the contractor responsible for concrete placement for structural concrete used in exterior and interior footings, interior slabs on-ground, garage slabs, wall foundations and concrete exposed to weather such as driveways, patios, porches, walkways, ramps, steps, curbs, etc.

TABLE 2
Soil Corrosivity Screening Results

Test	Test Results	Classification	General Recommendations
Soluble Sulfates (Cal 417)	0.010 percent	S0 ⁽¹⁾	Type II cement; minimum $f_c^{(2)} = 2,500$ psi; no water/cement ratio restrictions
pH (Cal 643)	8.2	Moderately Alkaline	No special recommendations
Soluble Chloride (Cal 422)	247 ppm	C1 ⁽²⁾	Residence: No special recommendations, minimum concrete cover on reinforcement
Resistivity (Cal 643)	14,000 ohm-cm	Mildly Corrosive ³	No special recommendations

Notes:

1. ACI 318-14, Section 19.3
2. ACI 318-14, Section 19.3
3. Pierre R. Roberge, “Handbook of Corrosion Engineering”

Post-Grading Considerations

Precise Grading and Drainage

Surface and subsurface drainage systems consisting of sloping concrete flatwork, drainage swales and possibly subsurface area drains will be constructed on the subject lots to collect and direct all surface water to the adjacent streets. In addition, the ground surface around the proposed buildings should be sloped to provide a positive drainage gradient away from the structures. The purpose of the drainage systems is to prevent ponding of surface water within the level areas of the site and against building foundations and associated site improvements. The drainage systems should be properly maintained throughout the life of the proposed development.

Section 1804.3 of the 2022 CBC requires that "The ground immediately adjacent to the foundation shall be sloped away from the building at a slope of not less than one unit vertical in 20 units horizontal (5-percent slope) for a minimum distance of 10 feet (3048 mm) measured perpendicular to the face of the wall." Further, "Swales used for this purpose shall be sloped a minimum of 2 percent where located within 10 feet (3048 mm) of the building foundation."

These provisions fall under the purview of the Design Civil Engineer. However, exceptions to allow modifications to these criteria are provided within the same section of the Code as "Where climatic or soil conditions warrant, the slope of the ground away from the building foundations is permitted to be reduced to not less than one unit in 48 units horizontal (2-percent slope)." This exemption provision appears to fall under the purview of the Geotechnical Engineer-of-Record.

It is our understanding that the state-of-the-practice for projects in various cities and unincorporated areas of Riverside County, as well as throughout Southern California, has been to construct earthen slopes at a 2 percent minimum gradient away from the foundations and at 1 percent minimum for earthen swale gradients. Structures constructed and properly maintained under those criteria have performed satisfactorily. Therefore, considering the semi-arid climate, site soil conditions and an appropriate irrigation regime, Petra considers that the implementation of 2 percent slopes away from the structures and 1 percent swales to be acceptable for the subject lots.

It should be emphasized that homeowners are cautioned that the slopes away from the structures and swales shall be properly maintained, not to be obstructed, and that future improvements are not to alter established gradients unless replaced with suitable alternative drainage systems. Further, where the flow line of the

swale exists within five feet of the structure, adjacent footings shall be deepened appropriately to maintain minimum embedment requirements, measured from the flow line of the swale.

Utility Trenches

All utility trench backfill should be compacted to a minimum relative compaction of 90 percent. Trench backfill materials should be free of oversize rock and placed in lifts no greater than approximately 12 inches in thickness, watered or air-dried as necessary to achieve near optimum moisture conditions, and then mechanically compacted in place to a minimum relative compaction of 90 percent. A representative of the project geotechnical consultant should probe and test the backfills to verify adequate compaction.

As an alternative for shallow trenches where pipe or utility lines may be damaged by mechanical compaction equipment, such as under building floor slabs, clean sand having a sand equivalent (SE) value of 30 or greater may be utilized. The sand backfill materials should be watered to achieve near optimum moisture conditions and then tamped into place. No specific relative compaction will be required; however, observation, probing, and if deemed necessary, testing should be performed by a representative of the project geotechnical consultant to verify an adequate degree of compaction.

If clean, imported sand is to be used for backfill of exterior utility trenches, it is recommended that the upper 12 inches of trench backfill materials consist of properly compacted onsite soil materials. This is to mitigate infiltration of irrigation and rainwater into granular trench backfill materials.

Where an exterior and/or interior utility trench is proposed in a direction parallel to a building footing, the bottom of the trench should not extend below a 1:1 (horizontal to vertical) plane projected downward from the bottom edge of the adjacent footing. Where this condition occurs, the adjacent footing should be deepened, or the utility constructed, and the trench backfilled and compacted prior to footing construction. Where utility trenches cross under a building footing, these trenches should be backfilled with on-site soils at the point where the trench crosses under the footing to reduce the potential for water to migrate under the floor slabs.

Retaining Wall Design Recommendations

A continuous retaining walls is proposed along the southeasterly property line at the rear yard of Lots 1 through 13. The retained height of this retaining wall is expected to vary from 4 to 6 feet with the adjacent property being at a higher elevation. The following provides our preliminary recommendations for design and construction of this retaining wall.

Footing Embedment

The base of retaining-wall footings constructed on level ground may be founded at a depth of 24 inches or more below the lowest adjacent final grade. Footing trenches should be observed by the project geotechnical representative to document that the footing trenches have been excavated into competent bearing soils and to the embedment recommended above. These observations should be performed prior to placing forms or reinforcing steel.

Allowable Soil Bearing Capacities

A basic allowable soil bearing capacity of 1,500 pounds per square foot, including dead and live loads, may be utilized for design of 12-inch-wide continuous footings founded at a minimum depth of 12 inches below the lowest adjacent final grade. This value may be increased by 20 percent for each additional foot of depth and by 10 percent for each additional foot of width to a maximum value of 2,500 pounds per square foot. Recommended allowable bearing values include both dead and live loads and may be increased by one-third for short duration wind and seismic forces.

Lateral Resistance

A passive earth pressure of 250 pounds per square foot per foot of depth, to a maximum value of 2,500 pounds per square foot, may be used to determine lateral bearing resistance for footings. However, when calculating passive resistance, the resistance of the upper 6 inches of the soils should be ignored in areas where the footings will not be covered with concrete flatwork, or where the thickness of soil cover over the top of the footing is less than 12 inches. In addition, a coefficient of friction of 0.30 times the dead load forces may be used between concrete and the supporting soils to determine lateral sliding resistance. The above values may be increased by one-third when designing for transient wind or seismic forces. It should be noted that the above values are based on the condition where footings are cast in direct contact with engineered fill or competent native soils. In cases where the footing sides are formed, all backfill placed against the footings upon removal of forms should be compacted to at least 90 percent of the applicable laboratory maximum dry density.

Active Earth Pressures

On-site fill materials that will be retained by the proposed retaining wall are considered loose or soft and are expected to exhibit non- to medium expansion potential. An active earth pressure equivalent to fluids having densities of 45 and 75 pounds per cubic foot should be used for design of cantilevered walls retaining a level backfill and ascending 2:1 backfill, respectively. The above values are for retaining walls that have

been supplied with a proper subdrain system (see Figure RW-1). All walls should be designed to support any adjacent structural surcharge loads imposed by other nearby walls or footings in addition to the active earth pressure.

Earthquake Loads on Retaining Walls

Note 1 of Section 1803.5.12 of the 2022 CBC indicates that the dynamic seismic lateral earth pressures on foundation walls and retaining walls supporting more than 6 feet of backfill height due to design earthquake ground motions be determined. We understand that the retained height of the proposed retaining along the southeasterly property line will be 6 feet or less. As such, no seismic lateral earth pressure surcharge is required for the design of the proposed wall.

Masonry Screen Walls

Construction on or Near the Tops of Descending Slopes

Continuous footings for masonry walls proposed on or within 5 feet from the top of a descending cut or fill slope should be deepened such that a horizontal clearance of 5 feet is maintained between the outside bottom edge of the footing and the slope face. The footings should be reinforced with two No. 4 bars, one top and one bottom. Plans for top-of-slope masonry walls proposing pier and grade beam footings should be reviewed by the project geotechnical consultant prior to construction.

Construction on Level Ground

Where masonry walls are proposed on level ground and 5 feet or more from the tops of descending slopes, the footings for these walls may be founded 18 inches or more below the lowest adjacent final grade. These footings should also be reinforced with two No. 4 bars, one top and one bottom.

Construction Joints

To reduce the potential for unsightly cracking related to the effects of differential settlement, positive separations (construction joints) should be provided in the walls at horizontal intervals of approximately 20 to 25 feet and at each corner. The separations should be provided in the blocks only and not extend through the footings. The footings should be placed monolithically with continuous rebars to serve as effective "grade beams" along the full lengths of the walls.

Tentative Pavement Design Recommendations

The final pavement section should be designed once rough grading has occurred and the R-Value of the resulting subgrade can be determined. For the purposes of this preliminary evaluation, we utilized an assumed R-value of 25 based on Sand Equivalent test results by 2014 SEC, and Traffic Indices (TI) of 5.0 and 5.5 for the interior streets and cul-de-sac. The following pavement sections have been computed in accordance with Caltrans design procedures and presented in the following table, Table 3.

TABLE 3
Preliminary Structural Pavement Section

Location	Assumed Design R-value	Traffic Index	Pavement Section
Interior Streets “A” thru “D”	25	5.5	4 in. AC / 6 in. AB*
Alleyways	25	5.0	3 in. AC / 4 in. AB

Notes: AC = Asphalt Concrete AB = Aggregate Base
* City of Riverside Minimum Section

Final pavement design recommendations should be provided based on sampling and testing at the completion of rough grading and the values of traffic indices that should be provided by the project civil engineer. The project civil engineer should confirm with the City before specifying any pavement section that may be less than the presumed minimum. Subgrade soils should be properly compacted, smooth, and non-yielding prior to pavement construction. The upper 12 inches of subgrade soils should be compacted to no less than 95 percent relative compaction with reference to ASTM D 1557.

Aggregate base materials in paved areas should be Crushed Aggregate Base, Crushed Miscellaneous Base, or Processed Miscellaneous Base conforming to Section 200-2 of the Standard Specifications for Public Works Construction (Greenbook). The base materials should be brought to uniform moisture near optimum moisture then compacted to at least 95 percent of the applicable maximum density standard as determined per ASTM D1557. Asphaltic concrete materials, where utilized, and construction should conform to Section 203 of the Greenbook.

Preliminary Infiltration Rates

Shallow Infiltration Test Results

Prior field infiltration tests reported by 2014 SEC were at three locations within the subject site to evaluate the infiltration rate of the silty sand soils at a depth of 2 feet below existing grades. The tests indicated an

un-factored infiltration rate ranging from 2.8 to 17.9 inches per hour. 2014 SEC test I-1 near the northeasterly corner is the closest test location to the currently proposed basin, which indicated a rate of 2.8 inches per hour at a depth of 2 feet below grade.

GRADING PLAN REVIEW

This report is based on our supplemental evaluations, the prior consultant's geotechnical report/data as well as the current tentative tract map prepared by Adkan Engineers. We recommend that our firm be retained to review the preliminary and final rough grading plans when they become available. Additional recommendations and/or modification of the recommendations provided herein will be provided if necessary, depending on the results of the grading plan review.

If additional or alternative improvements are considered in the future, our firm should be notified so that we may provide design recommendations. It is further recommended that we be engaged to review the final design drawings, specifications and grading plan prior to any new construction. If we are not provided the opportunity to review these documents with respect to the geotechnical aspects of new construction and grading, it should not be assumed that the recommendations provided herein are wholly or in part applicable to the proposed construction.

REPORT LIMITATIONS

This report is based on the project site, current design concept, and our supplemental subsurface exploration and geotechnical laboratory testing and analysis. The materials encountered on the project site and utilized in our laboratory evaluation are believed representative of the site area; however, soil materials and conditions can vary in characteristics between excavations, both laterally and vertically.

The conclusions and opinions contained in this report are based on the results of the described geotechnical evaluations and represent our professional judgment. This report has been prepared consistent with that level of care being provided by other professionals providing similar services at the same locale and in the same time period. The contents of this report are professional opinions and as such, are not to be considered a guaranty or warranty. This report has not been prepared for use by parties or projects other than those named or described herein. This report may not contain sufficient information for other parties or other purposes. In addition, this report should be reviewed and updated after a period of 1 year or if the site ownership or project concept changes from that described herein.

It has been a pleasure to be of service to you on this project. Should you have questions regarding the contents of this report or should you require additional information, please contact this office.

Respectfully submitted,

PETRA GEOSCIENCES, INC.,



Douglass Johnston
Senior Associate Geologist
CEG 2477

DJ/SJ/lv



3/13/24

Siamak Jafroudi, PhD
Senior Principal Engineer
GE 2024



W:\2020-2025\2023\300\23-341\Reports\23-341 110 Updated Preliminary Geotechnical Investigation.docx

REFERENCES

- Adkan Engineers, 2024, Tentative Tract No. 38921, 40-scale *preliminary plan, undated*.
- American Concrete Institute, 2008, Building Code Requirements for Structural Concrete (ACI 318-08) and Commentary.
- California Department of Water Resources, 2023, Water Data Library, accessed December, <http://www.water.ca.gov/waterdatalibrary/groundwater/>
- California Geologic Survey, 2008, Guidelines for Evaluating and Mitigating Seismic Hazards in California: CGS Special Publication 117A.
- California Geological Survey, 2018, Earthquake Fault Zones, A Guide for Government Agencies, Property Owners/Developers, and Geoscience Practitioners for Assessing Fault Rupture Hazards in California, Special Publication 42.
- California Geologic Survey, 2023, Earthquake Zones of Required Investigation, Riverside West Quadrangle, accessed December, <https://maps.conservation.ca.gov/cgs/EQZApp/app/>
- County of Riverside, 2023, Map My County System, version 11.5, accessed December, https://gis.countyofriverside.us/Html5Viewer/?viewer=MMC_Public
- Engineering Association of California (SEAOC) and California's Office of Statewide Health Planning and Development (OSHDP), Seismic Design Maps, with ASCE 7-16 Design Code Reference Document, <https://seismicmaps.org/>
- Google Earth™ 2023, by Google Earth, Inc., <http://www.google.com/earth/index.html>, accessed December.
- International Building Code, 2022 California Building Code, California Code of Regulations, Title 24, Part 2, Volume 2 of 2, California Building Standards Commission.
- ktgy Architecture + Planning, 2023, Conceptual Site Plan, Option 3j, dated December 21.
- Morton, D. M. and Cox, B. F., 2001, Geologic Map of the Riverside West 7.5' Quadrangle, Riverside County, California, Version 1.0, U.S.G.S. Open-File Report 01-451.
- Petra Geosciences, Inc., 2023, Feasibility/Due-Diligence Desktop Geotechnical Review, *Proposed 48 Lot Residential Project*, Assessor's Parcel Number 136-220-016, 7.9-Acre Site at SEC of Victoria and La Sierra Avenues, City of Riverside, Riverside County California, *prepared for Warmington Residential*, dated December 14.
- Soil Exploration Company, Inc., 2014, Preliminary Geotechnical Investigation/Liquefaction Evaluation / Infiltration Tests Report, Proposed 8.8± Acre, 14 Lot Residential Subdivision, SEC of Victoria Avenue and La Sierra Avenue (APN 136-220-016), City of Riverside, California; *prepared for Adkan Engineers*, dated January 24.
- _____, 2019, California Building Code (CBC) 2016 Seismic Update, Proposed 8.8±Acre, 14 Lot Residential Subdivision, SEC Victoria Avenue and La Sierra Avenue, City of Riverside, California, *prepared for West Coast Hotels Group, LLC*, dated December 16.
- Standard Specifications for Public Works Construction (Greenbook), 2021 Edition, BNI Publishers
- UC Santa Barbara Library, 2023, accessed December, http://mil.library.ucsb.edu/ap_indexes/FrameFinder/

FIGURES



Project Site

PETRA GEOSCIENCES, INC.
 40880 County Center Drive, Suite M
 Temecula, California 92591
 PHONE: (951) 600-9271
 COSTA MESA TEMECULA VALENCIA PALM DESERT CORONA

Site Location Map

Tentative Tract 38921
 La Sierra and Victoria Avenues
 City of Riverside, California



DATE: March 2024
 J.N.: 23-341

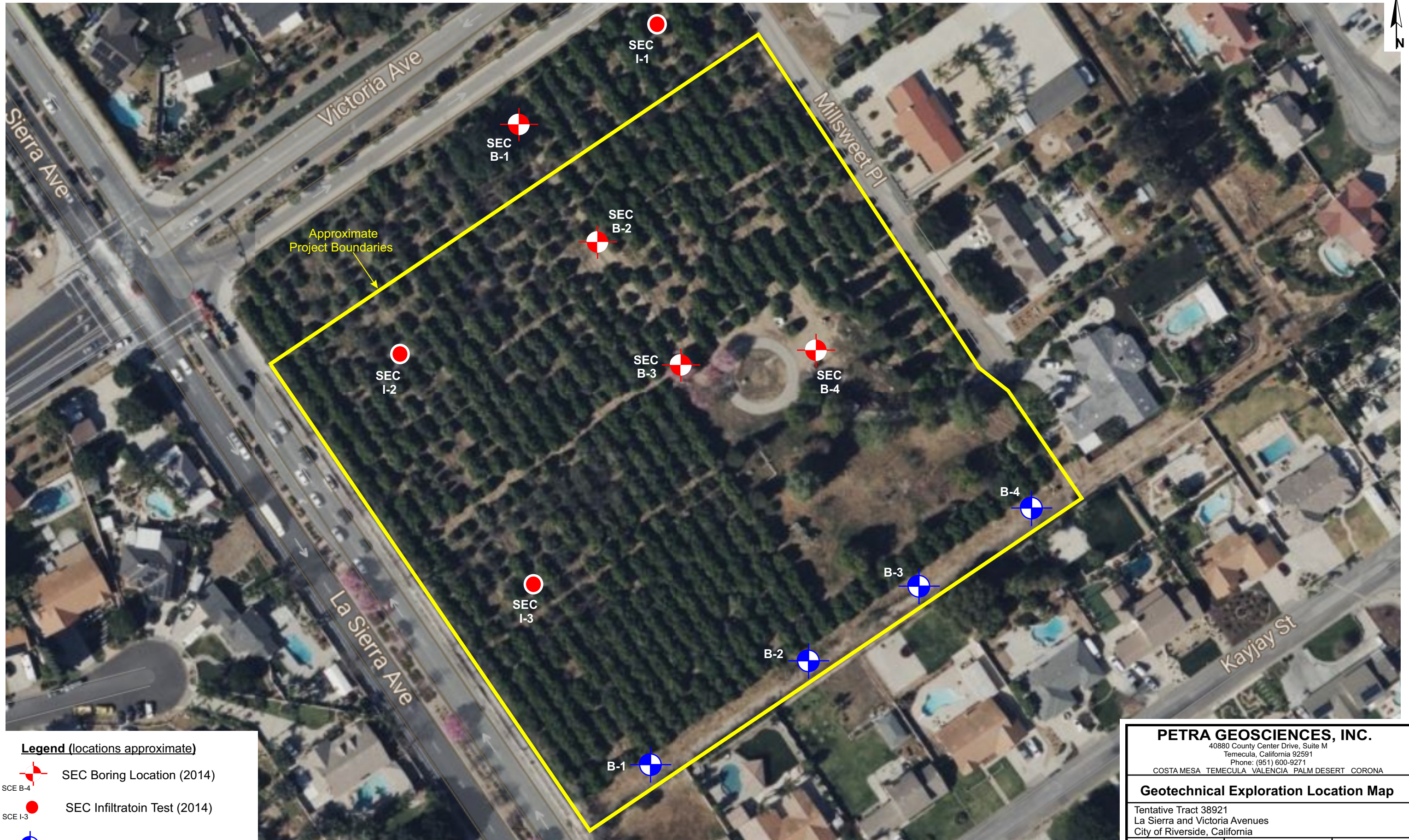

Figure 1

Basemap: Goolge Maps, 2023 Image



Approximate Project Boundaries

Legend (locations approximate)

-  SEC Boring Location (2014)
-  SEC Infiltration Test (2014)
-  Petra Boring Location (this study)

PETRA GEOSCIENCES, INC.

40880 County Center Drive, Suite M
 Temecula, California 92591
 Phone: (951) 600-9271
 COSTA MESA TEMECULA VALENCIA PALM DESERT CORONA

Geotechnical Exploration Location Map

Tentative Tract 38921
 La Sierra and Victoria Avenues
 City of Riverside, California

 DATE: March 2024
 J.N.: 23-341

Figure 2

Reference: Bing Maps, 2023 Image

APPENDIX A

FIELD EXPLORATION LOGS (BORINGS) PETRA and 2014 SEC









Unified Soil Classification System							
Coarse-grained Soils Soils > 1/2 of materials is larger than #200 sieve	The No. 200 U.S. Standard Sieve is about the smallest particle visible to the naked eye	GRAVELS more than half of coarse fraction is larger than #4 sieve	Clean Gravels (less than 5% fines)	GW Well-graded gravels, gravel-sand mixtures, little or no fines			
			Gravels with fines	GP Poorly-graded gravels, gravel-sand mixtures, little or no fines			
		SANDS more than half of coarse fraction is smaller than #4 sieve	Clean Sands (less than 5% fines)	GM Silty Gravels, poorly-graded gravel-sand-silt mixtures			
			Sands with fines	GC Clayey Gravels, poorly-graded gravel-sand-clay mixtures			
		Fine-grained Soils Soils < 1/2 of materials is smaller than #200 sieve	The No. 200 U.S. Standard Sieve is about the smallest particle visible to the naked eye	SILTS & CLAYS Liquid Limit Less Than 50	SW Well-graded sands, gravelly sands, little or no fines		
					SP Poorly-graded sands, gravelly sands, little or no fines		
				SILTS & CLAYS Liquid Limit Greater Than 50	SM Silty Sands, poorly-graded sand-gravel-silt mixtures		
					SC Clayey Sands, poorly-graded sand-gravel-clay mixtures		
				Highly Organic Soils			ML Inorganic silts & very fine sands, silty or clayey fine sands, clayey silts with slight plasticity
							CL Inorganic clays of low to medium plasticity, gravelly clays, sandy clays, silty clays, lean clays
OL Organic silts & clays of low plasticity							
MH Inorganic silts, micaceous or diatomaceous fine sand or silt							
CH Inorganic clays of high plasticity, fat clays							
OH Organic silts and clays of medium-to-high plasticity							
			PT Peat, humus swamp soils with high organic content				

Grain Size			
Description	Sieve Size	Grain Size	Approximate Size
Boulders	>12"	>12"	Larger than basketball-sized
Cobbles	3 - 12"	3 - 12"	Fist-sized to basketball-sized
Gravel	coarse 3/4 - 3"	3/4 - 3"	Thumb-sized to fist-sized
	fine #4 - 3/4"	0.19 - 0.75"	Pea-sized to thumb-sized
Sand	coarse #10 - #4	0.079 - 0.19"	Rock salt-sized to pea-sized
	medium #40 - #10	0.017 - 0.079"	Sugar-sized to rock salt-sized
	fine #200 - #40	0.0029 - 0.017"	Flour-sized to sugar-sized to
Fines	Passing #200	<0.0029"	Flour-sized and smaller

Modifiers	
Trace	< 1 %
Few	1 - 5 %
Some	5 - 12 %
Numerous	12 - 20 %

Laboratory Test Abbreviations			
MAX	Maximum Dry Density	MA	Mechanical (Particle Size) Analysis
EXP	Expansion Potential	AT	Atterberg Limits
SO4	Soluble Sulfate Content	#200	#200 Screen Wash
RES	Resistivity	DSU	Direct Shear (Undisturbed Sample)
pH	Acidity	DSR	Direct Shear (Remolded Sample)
CON	Consolidation	HYD	Hydrometer Analysis
SW	Swell	SE	Sand Equivalent
CL	Chloride Content	OC	Organic Content
RV	R-Value	COMP	Mortar Cylinder Compression

Bedrock Hardness	
Soft	Can be crushed and granulated by hand; "soil like" and structureless
Moderately Hard	Can be grooved with fingernails; gouged easily with butter knife; crumbles under light hammer blows
Hard	Cannot break by hand; can be grooved with a sharp knife; breaks with a moderate hammer blow
Very Hard	Sharp knife leaves scratch; chips with repeated hammer blows

Sampler and Symbol Descriptions	
	Approximate Depth of Groundwater Encountered
	Approximate Depth of Standing Groundwater
	Modified California Split Spoon Sample
	No Recovery in Mod. Calif. Split Spoon Sample
	Standard Penetration Test
	Shelby Tube Sample
	Bulk Sample
	No Recovery in SPT Sampler
	No Recovery in Shelby Tube

Notes:
 Blows Per Foot: Number of blows required to advance sampler 1 foot (unless a lesser distance is specified). Samplers in general were driven into the soil or bedrock at the bottom of the hole with a standard (140 lb.) hammer dropping a standard 30 inches unless noted otherwise in Log Notes. Drive samples collected in bucket auger borings may be obtained by dropping non-standard weight from variable heights. When a SPT sampler is used the blow count conforms to ASTM D-1586

EXPLORATION LOG

Project: T.T. 38921		Boring No.: B-1							
Location: La Sierra and Victoria, Riverside		Elevation: 839±							
Job No.: 23-341	Client: Warmington	Date: 2/29/24							
Drill Method: 8" Hollow Stem Auger	Driving Weight: 140 lbs / 30"	Logged By: SS							
Depth (Feet)	Lithology	Material Description	W A T E R	Samples		Laboratory Tests			
				Blows per 6 in.	C o r e	B u i k	Moisture Content (%)	Dry Density (pcf)	Other Lab Tests
0		ARTIFICIAL FILL (af) Silty Sand (SM): Light brown to brown, moist, loose, fine- to coarse-grained, some gravel. Silty Sand to Sandy Silt (SM-ML): Brown to pale red, moist, soft, fine- to coarse-grained, no gravel.		3	█		13.6	93.3	
				2	█				
				2	█		8.4	100.7	
				3	█				
5		firm, fine- to medium-grained, trace coarse sand.		2	█		7.2	105.8	DS
				4	█				
				4	█				
		YOUNGER ALLUVIUM (Qya) Sandy Silt (ML): Light brown to pale yellow, slightly moist to moist, stiff, fine- to medium-grained, trace coarse sand. dry to slightly moist.		4	█		4.1	101.9	
				6	█				
				8	█				
10				6	█		5.1	106.3	
				10	█				
				13	█				
15		slightly moist, firm.		2	▴				
				3	▴				
				4	▴				
20		OLDER ALLUVIUM (Qoal) Sandy Silt (ML): Light brown to brown, dry, hard, fine- to medium-grained, weakly cemented.		11	▴				
				18	▴				
				30	▴				
		Total Depth - 21.5' No groundwater encountered Boring was backfilled with cuttings.							
25									
30									

EXPLORATION LOG

Project: T.T. 38921		Boring No.: B-2							
Location: La Sierra and Victoria, Riverside		Elevation: 839±							
Job No.: 23-341	Client: Warmington	Date: 2/29/24							
Drill Method: 8" Hollow Stem Auger	Driving Weight: 140 lbs / 30"	Logged By: SS							
Depth (Feet)	Lithology	Material Description	W A T E R	Samples		Laboratory Tests			
				Blows per 6 in.	C o r e	B u i k	Moisture Content (%)	Dry Density (pcf)	Other Lab Tests
0		ARTIFICIAL FILL (af) Silty Sand to Sandy Silt (SM-ML): Light brown to brown, moist, soft, fine- to coarse-grained, some gravel. no gravel.		2 3 3	█	█	11.1	100.9	EI, CHEM, RS
5		YOUNGER ALLUVIUM (Qya) Sandy Silt (ML): Light brown to pale red, moist, soft, fine- to medium-grained. firm, trace coarse sand.		2 3 3	█	█	8.6	104.4	
				3 3 4	█	█	10.2	109.6	
				3 4 6	█	█	9.7	105.2	
10		stiff, fine- to coarse-grained.		6 10 8	█	█	6.1	105.8	
15		Brown to pale red, fine-grained.		5 7 8	▽	▽			
20		OLDER ALLUVIUM (Qoal) Sandy Silt (ML): Brown to pale yellow, slightly moist, hard, fine- to medium-grained, weakly cemented.		13 22 37	▽	▽			
		Total Depth - 21.5' No groundwater encountered Boring was backfilled with cuttings.							
25									
30									

EXPLORATION LOG

Project: T.T. 38921		Boring No.: B-3						
Location: La Sierra and Victoria, Riverside		Elevation: 839±						
Job No.: 23-341	Client: Warmington	Date: 2/29/24						
Drill Method: 8" Hollow Stem Auger	Driving Weight: 140 lbs / 30"	Logged By: SS						
Depth (Feet)	Lithology	Material Description	W A T E R	Samples		Laboratory Tests		
				Blows per 6 in.	C o r e B u i k	Moisture Content (%)	Dry Density (pcf)	Other Lab Tests
0		ARTIFICIAL FILL (af) <u>Silty Sand to Sandy Silt (SM-ML)</u> : Light brown to brown, moist, soft, fine- to coarse-grained, trace gravel. stiff, fine- to medium-grained, trace coarse sand, no gravel. moist to very moist, firm.		4 6 7		15.4	102.5	
			2 3 4			10.7	104.9	
5		YOUNGER ALLUVIUM (Qya) <u>Sandy Silt (ML)</u> : Light brown to pale red, moist, soft, fine- to medium-grained, trace coarse sand. firm, fine- to coarse-grained.		3 3 3		11.9	106.7	
			2 4 4			12.3	112.4	
10		<u>Silty Sand (SM)</u> : Light brown to pale red, moist, firm, fine- to coarse-grained.		4 5 6		9.3	111.5	
15		<u>Sandy Silt (ML)</u> : Brown to pale red, moist, very stiff, fine-grained.		6 10 18				
		OLDER ALLUVIUM (Qoal) <u>Sandy Silt (ML)</u> : Brown to pale yellow, slightly moist, hard, fine- to medium-grained, weakly cemented.						
20		Total Depth - 21.5' No groundwater encountered Boring was backfilled with cuttings.		50/2"				
25								
30								

EXPLORATION LOG

Project: T.T. 38921		Boring No.: B-4							
Location: La Sierra and Victoria, Riverside		Elevation: 840±							
Job No.: 23-341	Client: Warmington	Date: 2/29/24							
Drill Method: 8" Hollow Stem Auger	Driving Weight: 140 lbs / 30"	Logged By: SS							
Depth (Feet)	Lithology	Material Description	W A T E R	Samples		Laboratory Tests			
				Blows per 6 in.	C o r e	B u i k	Moisture Content (%)	Dry Density (pcf)	Other Lab Tests
0		ARTIFICIAL FILL (af) Silty Sand to Sandy Silt (SM-ML): Light brown to brown, moist, soft, fine- to coarse-grained, trace gravel. fine- to medium-grained, trace coarse sand, no gravel.		4 3 3	█		13.9	97.5	
5		YOUNGER ALLUVIUM (Qya) Sandy Silt (ML): Light brown to pale red, moist, soft, fine- to medium-grained, trace coarse sand. firm. slightly moist to moist.		2 2 3 3 3 4 4 5 5	█		11.6 11.2 9.0	105.0 103.4 115.2	
10		Silty Sand (SM): Light brown to pale red, slightly moist to moist, medium dense, fine- to coarse-grained, some gravel, trace broken cobble.		7 7 7	█		5.9	110.0	
15		Sandy Silt (ML): Brown to pale red, slightly moist, very stiff, fine-grained.		4 9 13	▴				
20		OLDER ALLUVIUM (Qoal) Sandy Silt (ML): Light brown to pale yellow, dry to slightly moist, hard, weakly cemented. Total Depth - 21.5' No groundwater encountered Boring was backfilled with cuttings.		15 28 30	▴				
25									
30									

GEOTECHNICAL BORING LOGS

Drill Hole No. B-1

Date: January 17, 2014

Drilling Company: WDI

Hole Diameter: 8" Drive Weight: 140 lbs. Drop: 30"

Project No. 13167-01

Type of Rig: B-61

Elevation: 816±

DEPTH (feet)	TYPE OF TEST	SAMPL E TEST	BLOWS PER 6 INCH	DRY DENSITY (%)	MOISTURE (%)	SOIL CLASSIFICATION USCS	GEOTECHNICAL DESCRIPTION LOGGED BY: <u>GL</u> SAMPLED BY: <u>GL</u>			
1	Alluvium					SM	SILTY SAND: Light brown, fine to coarse grained, dry, medium dense			
2										
3										
4				4/8/10	108.4			3.4		Dry, medium dense, micaceous % Passing No. 200 Sieve = 43 SE = 18
5										
6			X	3/4/4	-			-		Slightly moist, loose
7										
8										
9										
10										
11			X	3/6/4	-			-		Medium dense
12										
13										
14										
15										
16		X	7/9/11	-	-	ML	SANDY SILT: Light brown, slightly moist, stiff			
17										
18										
19										
20										
21	Bedrock	X	15/37/50	-	-	SM	SILTY SAND: Light brown, fine to coarse grained, very dense			
22										
23										
24										
25			X	19/39/50				TOTAL DEPTH = 25 FEET NO GROUNDWATER NO CAVING BORING BACKFILLED		

GEOTECHNICAL BORING LOGS

Drill Hole No. B-2

Date: January 17, 2014

Drilling Company: WDI

Hole Diameter: 8" Drive Weight: 140 lbs. Drop: 30"

Project No. 13167-01

Type of Rig: B-61

Elevation: 818.5±

DEPTH (feet)	TYPE OF TEST	SAMP LE TEST	BLOWS PER 6 INCH	DRY DENSITY (%)	MOISTURE (%)	SOIL CLASSIFICATION USCS	GEOTECHNICAL DESCRIPTION LOGGED BY: <u>GL</u> SAMPLED BY: <u>GL</u>	
1	Alluvium					SM	SILTY SAND: Light brown, fine to medium grained, slightly moist, loose, micaceous	
2								
3								
4		X	2/2/2	-	-		Loose SE = 29	
5								
6				3/4/4	113.3	13.1	ML	SANDY SILT: Light brown, moist, loose, micaceous % Passing No. 200 Sieve = 59
7								
8								
9								
10								
11		X	2/3/3	-	-		Loose	
12								
13								
14		X					CL-ML	SILTY CLAY: Light brown, moist, stiff
15		X	7/9/13	-	-			
16							TOTAL DEPTH = 15 FEET NO GROUNDWATER NO CAVING BORING BACKFILLED	
17								
18								
19								
20								
21								
22								
23								
24								
25								

GEOTECHNICAL BORING LOGS

Drill Hole No. B-3

Date: January 17, 2014

Drilling Company: WDI

Hole Diameter: 8" Drive Weight: 140 lbs. Drop: 30"

Project No. 13167-01

Type of Rig: B-61

Elevation: 822.5±

DEPTH (feet)	TYPE OF TEST	SAMPL E TEST	BLOWS PER 6 INCH	DRY DENSITY (%)	MOISTURE (%)	SOIL CLASSIFICATION USCS	GEOTECHNICAL DESCRIPTION LOGGED BY: <u>GL</u> SAMPLED BY: <u>GL</u>
1	Alluvium		3/4/4	-	-	SM	SILTY SAND: Light brown, fine to medium grained, dry, loose
2							
3							
4							
5							
6							
7							
8							
9							
10							
11			5/6/7	-	-	ML	SANDY SILT: Light brown, moist, stiff
12							
13							
14							
15							
16	Bedrock		7/9/13	-	-	SM	SILTY SAND: Light gray, weathered, medium dense
17							
18							
19							
20							
21			9/17/22	-	-		TOTAL DEPTH = 20 FEET NO GROUNDWATER NO CAVING BORING BACKFILLED
22							
23							
24							
25							

GEOTECHNICAL BORING LOGS

Drill Hole No. B-4

Date: January 17, 2014

Drilling Company: WDI

Hole Diameter: 8" Drive Weight: 140 lbs. Drop: 30"

Project No. 13167-01

Type of Rig: B-61

Elevation: 824±

DEPTH (feet)	TYPE OF TEST	SAMPL E TEST	BLOWS PER 6 INCH	DRY DENSITY (%)	MOISTURE (%)	SOIL CLASSIFICATION USCS	GEOTECHNICAL DESCRIPTION LOGGED BY: <u>GL</u> SAMPLED BY: <u>GL</u>		
1	Alluvium					SM	SILTY SAND: Light brown, fine to medium grained, slightly moist, loose		
2									
3									
4									
5									
6			X	3/4/5	-			-	Loose
7									
8									
9									
10									
11			X	5/5/5	-			-	Medium dense
12									
13									
14									
15									
16		X	5/8/11	-	-	ML	SANDY SILT: Light brown, slightly moist, stiff		
17									
18									
19	Bedrock	X				SM	SILTY SAND: Light brown, fine to coarse grained, very dense		
20			27/33/39	-	-				
21							TOTAL DEPTH = 20 FEET NO GROUNDWATER NO CAVING BORING BACKFILLED		
22									
23									
24									
25									

APPENDIX B

LABORATORY TEST PROCEDURES

LABORATORY DATA SUMMARY PETRA and 2014 SEC

LABORATORY TEST PROCEDURES

Soil Classification

Soils encountered within the exploration borings were initially classified in the field in general accordance with the visual-manual procedures of the Unified Soil Classification System (ASTM D 2488). The samples were re-examined in the laboratory and the classifications reviewed and then revised where appropriate.

In-Situ Moisture and Density

Moisture content and unit dry density of in-place soil were determined in representative strata and are depicted on the Exploration Logs, Appendix A.

Maximum Dry Density and Optimum Moisture

Maximum dry density and optimum moisture content were determined for a selected sample of soil and bedrock in accordance with Method A of ASTM D 1557 and the test data is presented on Plate B-1.

Expansion Index

An expansion index test was performed on a selected sample of soil in accordance with ASTM D 4829. The expansion potential classification was determined from 2010 CBC Section 1802.3.2 on the basis of the expansion index value. The test result and expansion potentials are presented on Plate B-1.

Soil Corrosivity

Chemical analyses were performed on a selected sample of soil to determine concentrations of soluble sulfate and chloride, as well as pH and resistivity. These tests were performed in accordance with California Test Method Nos. 417 (sulfate), 422 (chloride) and 643 (pH and resistivity). Test results are included on Plate B-1.

Direct Shear

The Coulomb shear strength parameters, i.e., angle of internal friction and cohesion, were determined for a both a remolded sample of onsite soil and an undisturbed sample of onsite soil. The tests were performed in general accordance with the current version of Test Method ASTM D 3080. Three specimens were prepared for each test. The test specimens were inundated and then sheared under various normal loads at a constant strain rate of 0.005 inch per minute. The results of the direct shear test are graphically presented on Plates B-2 and B-3.

LABORATORY DATA SUMMARY*													
Boring Number	Sample Depth (ft)	Soil Description	Max. Dry Density ¹ (pcf)	Optimum Moisture ¹ (%)	Expansion Index ²	USCS Soil Classification ³	Atterberg Limits ⁴			Sulfate Content ⁵ (%)	Chloride Content ⁶ (mg/L)	pH ⁷	Minimum Resistivity ⁷ (ohm-cm)
							LL	PL	PI				
B-2	0-5	Silty Sand-Sandy Silt	130.5	8.0	0	SM-ML	--	--	--	0.010	247	8.2	14,000

(--) Tests Not Performed

Test Procedures:

¹ Per ASTM Test Method D 1557

² Per ASTM Test Method D 4829

³ Per ASTM Test Method D 2487

⁴ Per ASTM Test Method D 4318

⁵ Per Caltrans Test Method 417

⁶ Per Caltrans Test Method 422

⁷ Per Caltrans Test Method 643

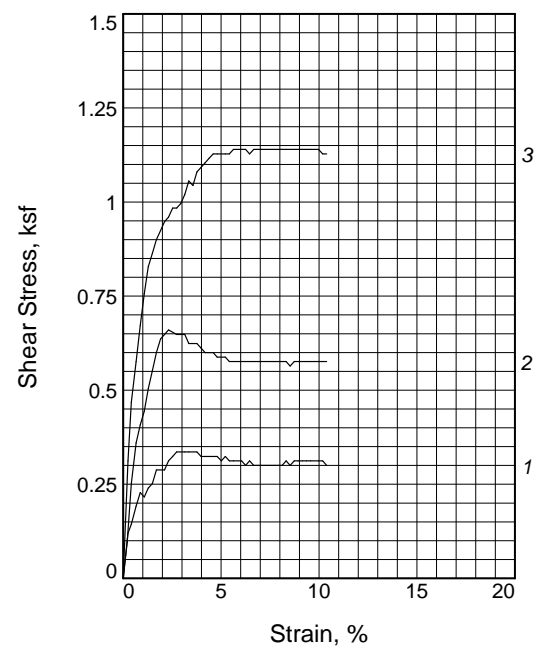
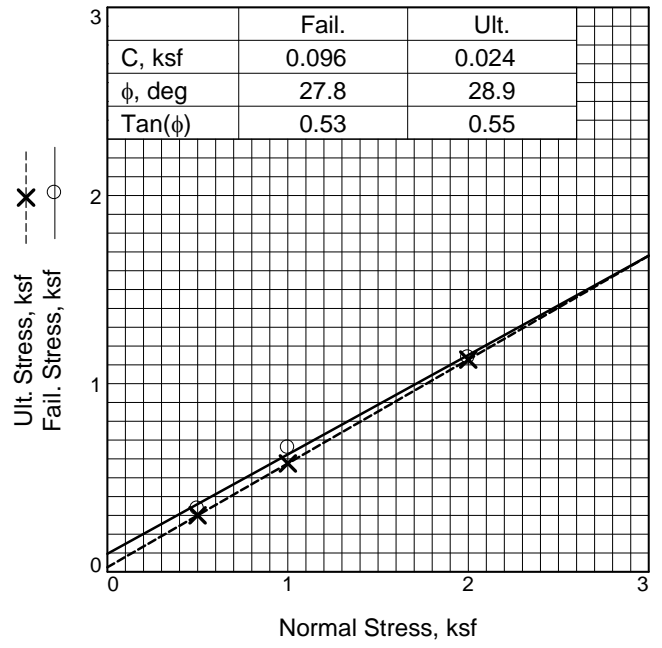
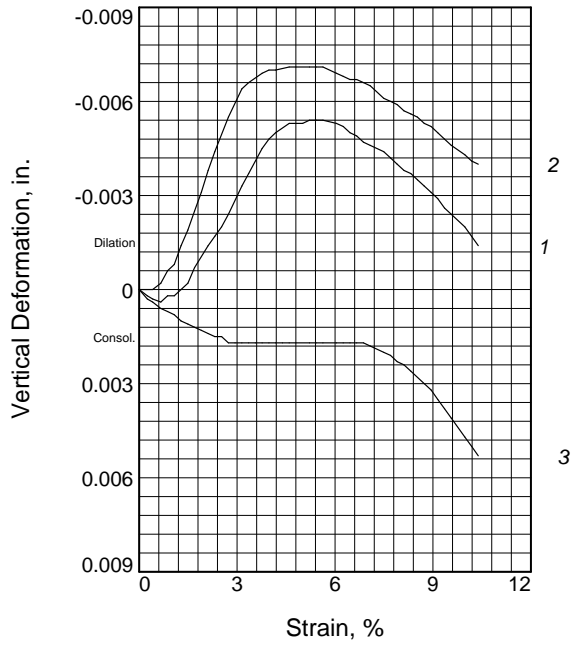

Sample No.		1	2	3
Initial	Water Content, %	7.2	7.2	7.2
	Dry Density, pcf	106.2	112.3	106.9
	Saturation, %	34.4	40.6	35.1
	Void Ratio	0.5578	0.4725	0.5471
	Diameter, in.	2.416	2.416	2.416
	Height, in.	1.004	1.009	1.000
At Test	Water Content, %	19.5	16.2	17.9
	Dry Density, pcf	108.3	114.5	110.9
	Saturation, %	97.8	96.5	96.5
	Void Ratio	0.5274	0.4449	0.4913
	Diameter, in.	2.416	2.416	2.416
	Height, in.	0.984	0.990	0.964
Normal Stress, ksf		0.500	1.000	2.000
Fail. Stress, ksf		0.336	0.660	1.140
Strain, %		3.8	2.3	10.0
Ult. Stress, ksf		0.300	0.576	1.128
Strain, %		10.4	10.4	10.4
Strain rate, in./min.		0.040	0.040	0.040

Sample Type: Undisturbed
Description: Brown Silty Fine to Coarse Sand
Specific Gravity= 2.65
Remarks:

Figure B-2

Client: Warmington
Project: La Sierra and Victoria
Source of Sample: 24L038 **Depth:** 5
Sample Number: B-1
Proj. No.: 23-341 **Date Sampled:**

Tested By: DI

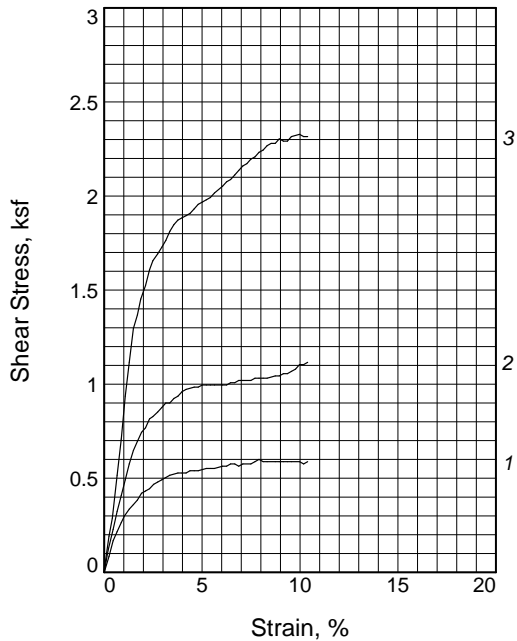
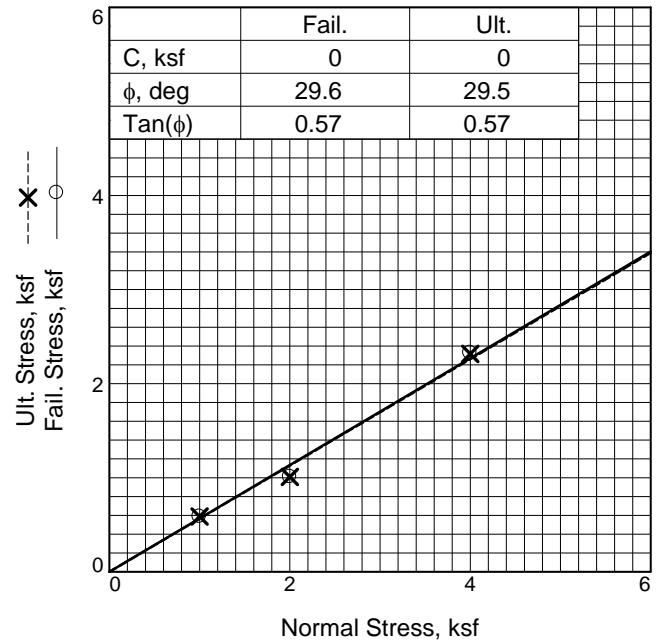
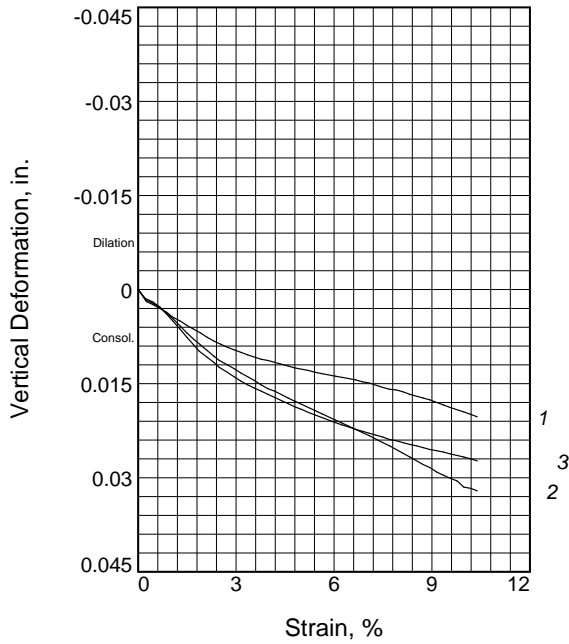

Sample No.	1	2	3	
Initial	Water Content, %	8.0	8.0	8.0
	Dry Density, pcf	117.5	117.7	117.5
	Saturation, %	52.0	52.1	52.0
	Void Ratio	0.4075	0.4061	0.4075
	Diameter, in.	2.416	2.416	2.416
	Height, in.	1.001	1.000	1.001
At Test	Water Content, %	14.6	13.1	12.6
	Dry Density, pcf	118.7	121.1	121.8
	Saturation, %	98.4	95.0	93.2
	Void Ratio	0.3933	0.3662	0.3584
	Diameter, in.	2.416	2.416	2.416
	Height, in.	0.991	0.972	0.966
Normal Stress, ksf	1.000	2.000	4.000	
Fail. Stress, ksf	0.588	1.008	2.328	
Strain, %	10.0	6.5	10.0	
Ult. Stress, ksf	0.588	1.008	2.316	
Strain, %	10.4	6.5	10.4	
Strain rate, in./min.	0.040	0.040	0.040	

Sample Type: Remold
Description: Brown Silty Fine to Coarse Sand
Specific Gravity= 2.65
Remarks: Brown Silty Fine to Coarse Sand

Client: Warmington
Project: La Sierra and Victoria
Source of Sample: 24L038 **Depth:** 0-5
Sample Number: B-2
Proj. No.: 23-341 **Date Sampled:**



Figure B-3

Tested By: DI

LABORATORY TEST RESULTS

SEC of Victoria Avenue and La Sierra Avenue
City of Riverside, California

SIEVE SIZE	B-1 @ 2.5' % PASSING	B-2 @ 5' % PASSING
3/8"	100	-
No. 4	99.5	100
No. 8	98	98
No. 16	93	91
No. 30	86	83
No. 50	78	77
No. 100	65	69
No. 200	43	59
SIEVE ANALYSIS TEST DATA		

B-1 @ 2.5'	B-2 @ 2.5'
18	29
SAND EQUIVALENT TEST DATA	

APPENDIX C

SEISMIC AND LIQUEFACTION PARAMETERS

SITE CLASSIFICATION DETERMINATION BASED ON N-SPT FOR SEISMIC DESIGN

Per Table 20.3-1 and Section 20.4.2 of ASCE 7-16

J.N: **23-341**

Project: **Warmington; Victoria & La Sierra**

Date: **12/7/2023**

Boring: **B-1**

Total Depth of Boring: **25** feet

SPT Test Interval: every **5** feet

Layer No. (i)	Depth to Soil/Rock Layer		Layer Thickness (d _i)	$\sum_{i=1}^n d_i$	Mod. Cal. Sampler Blow Counts ¹	Equivalent N-SPT ² (N _i)	N-SPT ³ (N _i)	$\sum_{i=1}^n \frac{d_i}{N_i}$
	Top	Bottom						
	ft	ft	ft	ft	blows/ft	blows/ft	blows/ft	
1	0	4.5	4.5	4.5	18	12		0.38
2	4.5	8	3.5	8.0			8	0.81
3	8	13	5	13.0			10	1.31
4	13	20	7	20.0			20	1.66
5	20	23.5	3.5	23.5			87	1.70
6	23.5	100	76.5	100.0			89	2.56
7	0	0	0	0.0		0	0	0.00
8	0	0	0	0.0		0	0	0.00
9	0	0	0	0.0		0		0.00
10	0	0	0	0.0		0		0.00
11	0	0	0	0.0		0		0.00
12	0	0	0	0.0		0		0.00
13	0	0	0	0.0		0		0.00
14	0	0	0	0.0		0		0.00
15	0	0	0	0.0		0		0.00



Average Field Standard Penetration Resistance (blows/ft)		Site Classification Per Table 20.3-1
$\bar{N} = \frac{\sum_{i=1}^n d_i}{\sum_{i=1}^n \frac{d_i}{N_i}} =$	39	D

- 1 Modified California sampler blow counts as directly measured in the field without corrections.
- 2 Equivalent SPT blow counts are calculated from field measured Modified California sampler blow counts using the standard Burmister formula (Burmister, 1948).
Eq. N-SPT = 0.651 x (Mod. Cal. Sampler Blow Counts)
- 3 Standard penetration resistance (ASTM D1586) not to exceed 100 blows /ft (305 blows /m) as directly measured in the field without corrections. When Refusal is met for a rock layer, this value shall be taken as 100 blows /ft (305 blows /m).

USGS web services were down for some period of time and as a result this tool wasn't operational, resulting in *timeout* error.
 USGS web services are now operational so this tool should work as expected.



Warmington; Victoria & La Sierra

Latitude, Longitude: 33.8875, -117.4618

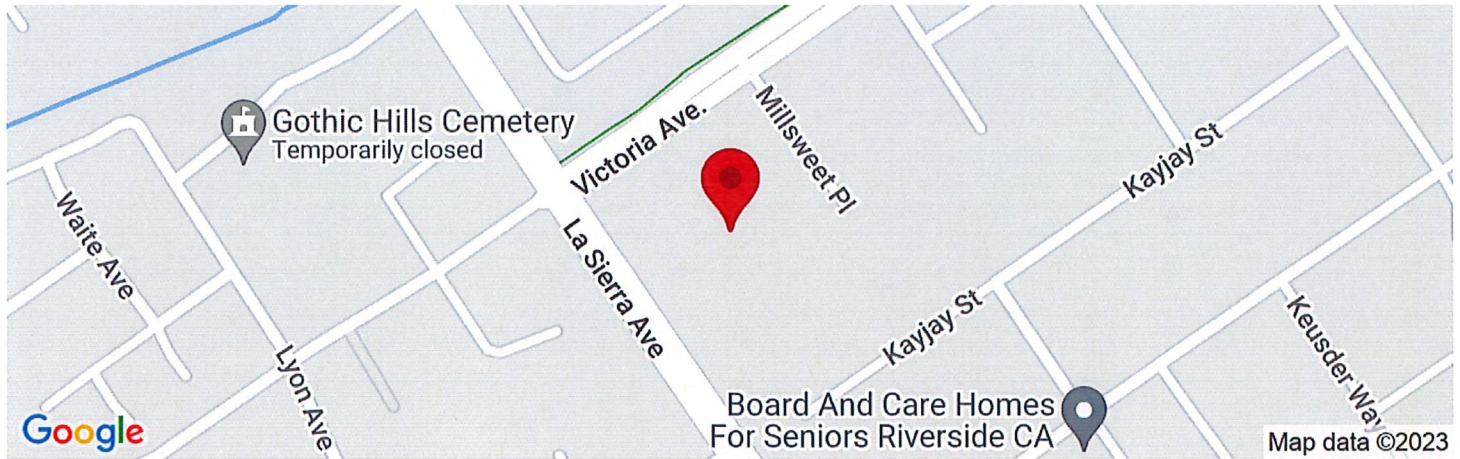

Date	12/7/2023, 5:53:05 PM
Design Code Reference Document	ASCE7-16
Risk Category	II
Site Class	D - Stiff Soil

Type	Value	Description
S _S	1.5	MCE _R ground motion. (for 0.2 second period)
S ₁	0.597	MCE _R ground motion. (for 1.0s period)
S _{MS}	1.5	Site-modified spectral acceleration value
S _{M1}	null -See Section 11.4.8	Site-modified spectral acceleration value
S _{DS}	1	Numeric seismic design value at 0.2 second SA
S _{D1}	null -See Section 11.4.8	Numeric seismic design value at 1.0 second SA

Type	Value	Description
SDC	null -See Section 11.4.8	Seismic design category
F _a	1	Site amplification factor at 0.2 second
F _v	null -See Section 11.4.8	Site amplification factor at 1.0 second
PGA	0.571	MCE _G peak ground acceleration
F _{PGA}	1.1	Site amplification factor at PGA
PGA _M	0.628	Site modified peak ground acceleration
T _L	8	Long-period transition period in seconds
SsRT	1.669	Probabilistic risk-targeted ground motion. (0.2 second)
SsUH	1.776	Factored uniform-hazard (2% probability of exceedance in 50 years) spectral acceleration
SsD	1.5	Factored deterministic acceleration value. (0.2 second)
S1RT	0.597	Probabilistic risk-targeted ground motion. (1.0 second)
S1UH	0.649	Factored uniform-hazard (2% probability of exceedance in 50 years) spectral acceleration.
S1D	0.6	Factored deterministic acceleration value. (1.0 second)
PGAd	0.571	Factored deterministic acceleration value. (Peak Ground Acceleration)

Type	Value	Description
PGA_{UH}	0.682	Uniform-hazard (2% probability of exceedance in 50 years) Peak Ground Acceleration
C_{RS}	0.94	Mapped value of the risk coefficient at short periods
C_{R1}	0.92	Mapped value of the risk coefficient at a period of 1 s
C_V	1.4	Vertical coefficient

DISCLAIMER

While the information presented on this website is believed to be correct, SEAO / OSHPD and its sponsors and contributors assume no responsibility or liability for its accuracy. The material presented in this web application should not be used or relied upon for any specific application without competent examination and verification of its accuracy, suitability and applicability by engineers or other licensed professionals. SEAO / OSHPD do not intend that the use of this information replace the sound judgment of such competent professionals, having experience and knowledge in the field of practice, nor to substitute for the standard of care required of such professionals in interpreting and applying the results of the seismic data provided by this website. Users of the information from this website assume all liability arising from such use. Use of the output of this website does not imply approval by the governing building code bodies responsible for building code approval and interpretation for the building site described by latitude/longitude location in the search results of this website.

Unified Hazard Tool



Please do not use this tool to obtain ground motion parameter values for the design code reference documents covered by the [U.S. Seismic Design Maps web tools](#) (e.g., the International Building Code and the ASCE 7 or 41 Standard). The values returned by the two applications are not identical.

Please also see the new [USGS Earthquake Hazard Toolbox](#) for access to the most recent NSHMs for the conterminous U.S. and Hawaii.

^ Input

Edition

Dynamic: Conterminous U.S. 2014 (u...

Spectral Period

Peak Ground Acceleration

Latitude

Decimal degrees

33.8875

Time Horizon

Return period in years

2475

Longitude

Decimal degrees, negative values for western longitudes

-117.4618

Site Class

259 m/s (Site class D)

^ Hazard Curve

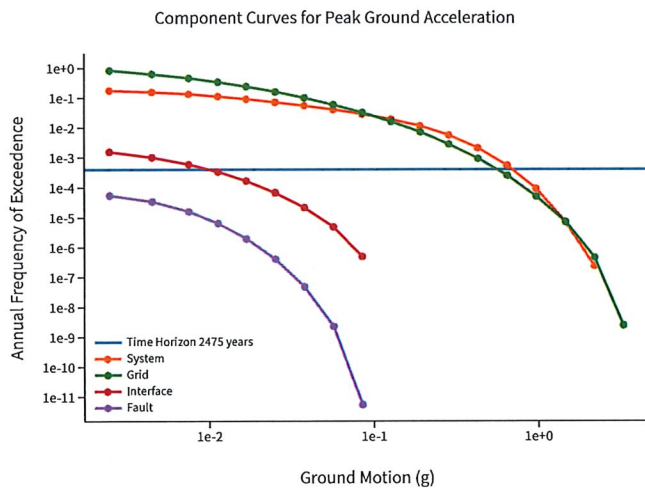
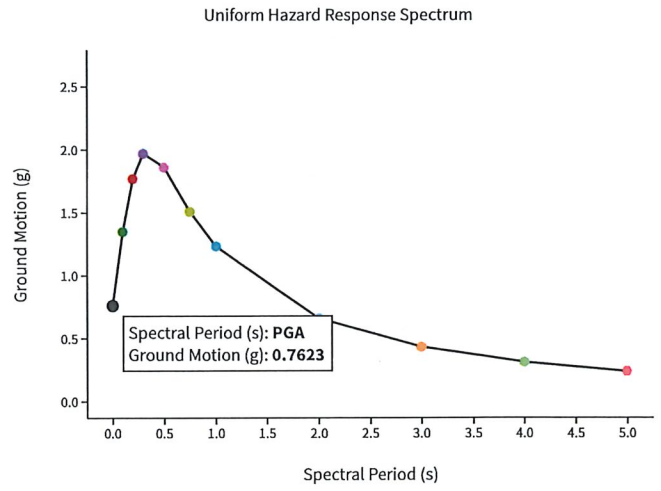
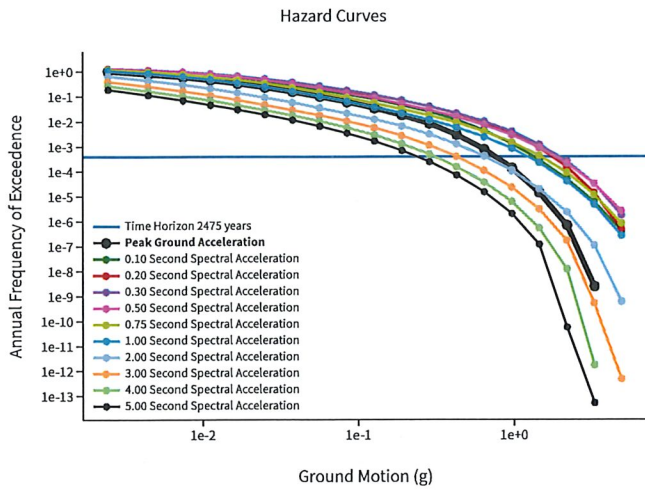

[View Raw Data](#)

Deaggregation

Component

Total

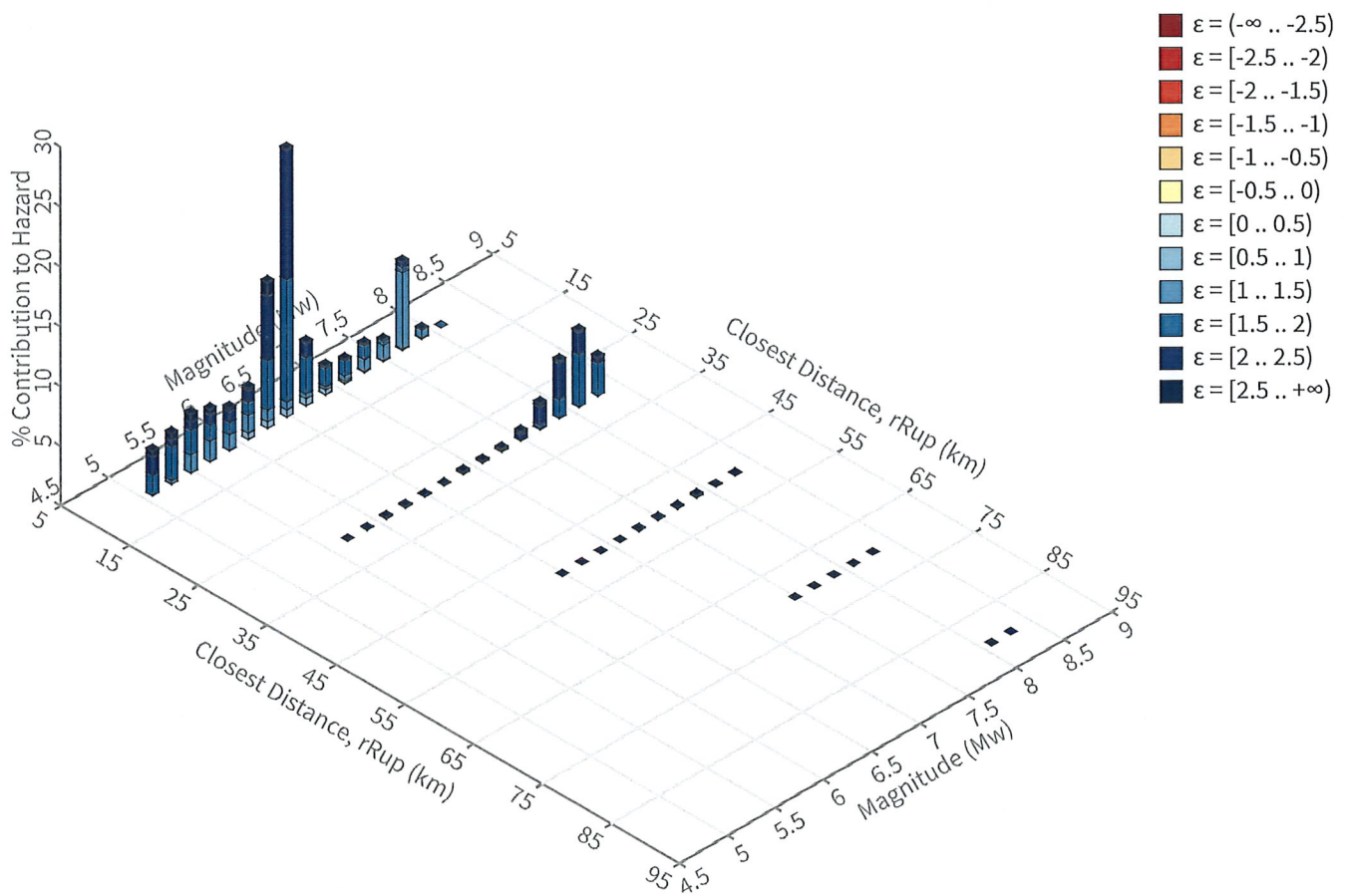

Summary statistics for, Deaggregation: Total

Deaggregation targets

Return period: 2475 yrs
Exceedance rate: 0.0004040404 yr⁻¹
PGA ground motion: 0.76227737 g

Recovered targets

Return period: 2968.3067 yrs
Exceedance rate: 0.00033689241 yr⁻¹

Totals

Binned: 100 %
Residual: 0 %
Trace: 0.09 %

Mean (over all sources)

m: 6.68
r: 14.01 km
 ϵ_0 : 1.86 σ

Mode (largest m-r bin)

m: 6.47
r: 11.3 km
 ϵ_0 : 1.96 σ
Contribution: 22.37 %

Mode (largest m-r- ϵ_0 bin)

m: 6.46
r: 11.73 km
 ϵ_0 : 2.17 σ
Contribution: 10.83 %

Discretization

r: min = 0.0, max = 1000.0, Δ = 20.0 km
m: min = 4.4, max = 9.4, Δ = 0.2
 ϵ : min = -3.0, max = 3.0, Δ = 0.5 σ

Epsilon keys

ϵ_0 : [-∞ .. -2.5)
 ϵ_1 : [-2.5 .. -2.0)
 ϵ_2 : [-2.0 .. -1.5)
 ϵ_3 : [-1.5 .. -1.0)
 ϵ_4 : [-1.0 .. -0.5)
 ϵ_5 : [-0.5 .. 0.0)
 ϵ_6 : [0.0 .. 0.5)
 ϵ_7 : [0.5 .. 1.0)
 ϵ_8 : [1.0 .. 1.5)
 ϵ_9 : [1.5 .. 2.0)
 ϵ_{10} : [2.0 .. 2.5)
 ϵ_{11} : [2.5 .. +∞]

Deaggregation Contributors

Source Set	Source	Type	r	m	ϵ_0	lon	lat	az	%
UC33brAvg_FM32		System							33.33
	Elsinore (Glen Ivy) rev [0]		11.58	6.82	1.83	117.545°W	33.811°N	222.12	20.06
	San Jacinto (San Bernardino) [4]		25.11	8.06	1.88	117.257°W	34.036°N	48.85	5.07
	San Andreas (San Bernardino N) [5]		36.17	7.99	2.24	117.269°W	34.171°N	29.36	2.00
	Elsinore (Glen Ivy) rev [1]		11.78	6.60	1.96	117.531°W	33.799°N	213.05	1.61
	Elsinore (Glen Ivy) rev [2]		14.46	6.29	2.33	117.481°W	33.759°N	186.91	1.30
UC33brAvg_FM31		System							33.18
	Elsinore (Glen Ivy) rev [0]		11.58	6.80	1.84	117.545°W	33.811°N	222.12	19.92
	San Jacinto (San Bernardino) [4]		25.11	8.06	1.87	117.257°W	34.036°N	48.85	5.11
	San Andreas (San Bernardino N) [5]		36.17	7.99	2.24	117.269°W	34.171°N	29.36	1.98
	Elsinore (Glen Ivy) rev [1]		11.78	6.57	1.97	117.531°W	33.799°N	213.05	1.50
	Elsinore (Glen Ivy) rev [2]		14.46	6.29	2.33	117.481°W	33.759°N	186.91	1.26
UC33brAvg_FM31 (opt)		Grid							16.90
	PointSourceFinite: -117.462, 33.919		6.11	5.68	1.47	117.462°W	33.919°N	0.00	3.22
	PointSourceFinite: -117.462, 33.919		6.11	5.68	1.47	117.462°W	33.919°N	0.00	3.22
	PointSourceFinite: -117.462, 33.937		7.06	5.85	1.57	117.462°W	33.937°N	0.00	2.59
	PointSourceFinite: -117.462, 33.937		7.06	5.85	1.57	117.462°W	33.937°N	0.00	2.59
UC33brAvg_FM32 (opt)		Grid							16.60
	PointSourceFinite: -117.462, 33.919		6.11	5.69	1.47	117.462°W	33.919°N	0.00	3.16
	PointSourceFinite: -117.462, 33.919		6.11	5.69	1.47	117.462°W	33.919°N	0.00	3.16
	PointSourceFinite: -117.462, 33.937		7.06	5.85	1.57	117.462°W	33.937°N	0.00	2.58
	PointSourceFinite: -117.462, 33.937		7.06	5.85	1.57	117.462°W	33.937°N	0.00	2.58

SPT Liquefaction Analysis

References:
 T.L.Youd, I.M.Idriss - Proceedings of the NCEER Workshop on Evaluation of Liquefaction Resistance of Soils
 D. Pradel - Procedure to Evaluate Earthquake-Induced Settlements in Dry Sandy Soils
 K.Tokimatsu, H.B.Seed - Evaluation of Settlements in Sands Due to Earthquake Shaking, ASCE JGE Vol.113, No.8, August 1986
 G.Zhang, P.K.Robertson, R.W.I.Brachman - Estimating Liquefaction-Induced Ground Settlements From CPT for Level Ground (CGJ39,2002)

Boring	B-1	Summary of analysis
		Total liquefaction settlement 1.21 inches
		Total dry sand settlement 0.02 inches
		Total earthquake-induced settlement 1.22 inches
		Number of evaluated intervals 7
		Number of potentially liquefiable intervals 2
		Average Factor of Safety 0.89
		Depth to first groundwater 5.00 feet
		Total thickness of evaluated profile 100.00 feet
		Profile thickness susceptible to liquefaction 8.00 feet

Earthquake loading: M 6.8
 PGA 0.628

Depth to Layer Top	Depth to Layer Bottom	SPT - N	Fines %	FS _{SPT,cs,Kg}	Interpreted Factor of Safety against liquefaction	Settlement
feet	feet					in
0	4.5	12	43	no liq	Not liquefiable - no groundwater	0.01
4.5	5	12	43	no liq	Not liquefiable - no groundwater	0.00
5	8	8	20	0.79	0.79 - liquefiable - FS < 1.3	0.53
8	13	10	20	0.99	0.99 - liquefiable - FS < 1.3	0.68
13	20	20	30	no liq	Not liquefiable - too dense	0.00
20	23.5	87	20	no liq	Not liquefiable - too dense	0.00
23.5	100	89	20	no liq	Not liquefiable - too dense	0.00

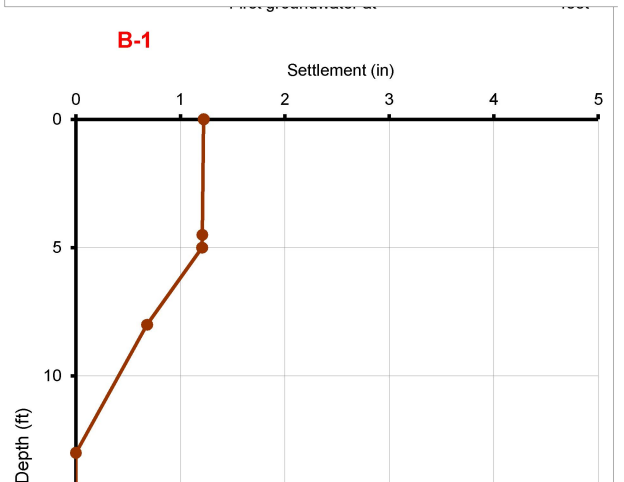
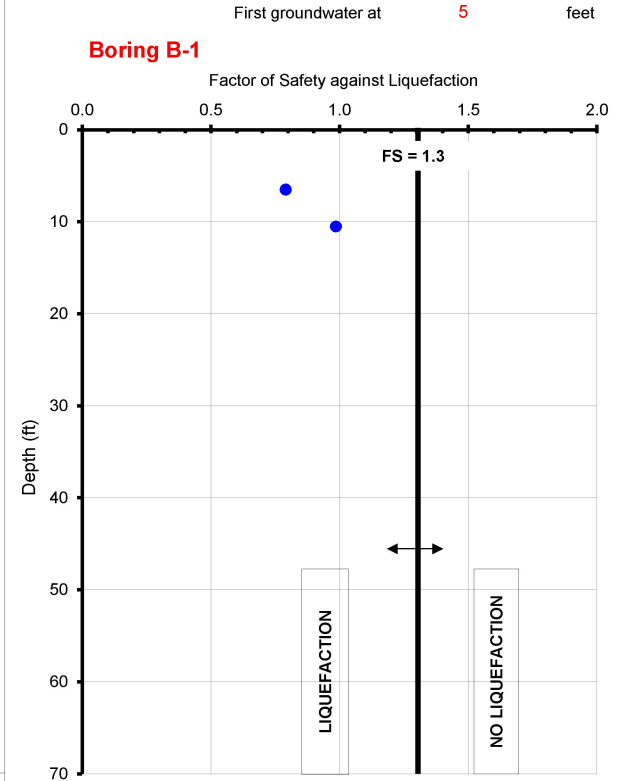

APPENDIX D

STANDARD GRADING SPECIFICATIONS

STANDARD GRADING SPECIFICATIONS

These specifications present the usual and minimum requirements for projects on which Petra Geosciences, Inc. (Petra) is the geotechnical consultant. No deviation from these specifications will be allowed, except where specifically superseded in the preliminary geology and soils report, or in other written communication signed by the Soils Engineer and Engineering Geologist of record (Geotechnical Consultant).

I. GENERAL

- A. The Geotechnical Consultant is the Owner's or Builder's representative on the project. For the purpose of these specifications, participation by the Geotechnical Consultant includes that observation performed by any person or persons employed by, and responsible to, the licensed Soils Engineer and Engineering Geologist signing the soils report.
- B. The contractor should prepare and submit to the Owner and Geotechnical Consultant a work plan that indicates the sequence of earthwork grading, the number of "spreads" and the estimated quantities of daily earthwork to be performed prior to the commencement of grading. This work plan should be reviewed by the Geotechnical Consultant to schedule personnel to perform the appropriate level of observation, mapping, and compaction testing as necessary.
- C. All clearing, site preparation, or earthwork performed on the project shall be conducted by the Contractor in accordance with the recommendations presented in the geotechnical report and under the observation of the Geotechnical Consultant.
- D. It is the Contractor's responsibility to prepare the ground surface to receive the fills to the satisfaction of the Geotechnical Consultant and to place, spread, mix, water, and compact the fill in accordance with the specifications of the Geotechnical Consultant. The Contractor shall also remove all material considered unsatisfactory by the Geotechnical Consultant.
- E. It is the Contractor's responsibility to have suitable and sufficient compaction equipment on the job site to handle the amount of fill being placed. If necessary, excavation equipment will be shut down to permit completion of compaction to project specifications. Sufficient watering apparatus will also be provided by the Contractor, with due consideration for the fill material, rate of placement, and time of year.
- F. After completion of grading a report will be submitted by the Geotechnical Consultant.

II. SITE PREPARATION

- A. Clearing and Grubbing
 - 1. All vegetation such as trees, brush, grass, roots, and deleterious material shall be disposed of offsite. This removal shall be concluded prior to placing fill.
 - 2. Any underground structures such as cesspools, cisterns, mining shafts, tunnels, septic tanks, wells, pipe lines, etc., are to be removed or treated in a manner prescribed by the Geotechnical Consultant.

STANDARD GRADING SPECIFICATIONS

III. FILL AREA PREPARATION

A. Remedial Removals/Overexcavations

1. Remedial removals, as well as overexcavation for remedial purposes, shall be evaluated by the Geotechnical Consultant. Remedial removal depths presented in the geotechnical report and shown on the geotechnical plans are estimates only. The actual extent of removal should be determined by the Geotechnical Consultant based on the conditions exposed during grading. All soft, loose, dry, saturated, spongy, organic-rich, highly fractured or otherwise unsuitable ground shall be overexcavated to competent ground as determined by the Geotechnical Consultant.
2. Soil, alluvium, or bedrock materials determined by the Soils Engineer as being unsuitable for placement in compacted fills shall be removed from the site. Any material incorporated as a part of a compacted fill must be approved by the Geotechnical Consultant.
3. Should potentially hazardous materials be encountered, the Contractor should stop work in the affected area. An environmental consultant specializing in hazardous materials should be notified immediately for evaluation and handling of these materials prior to continuing work in the affected area.

B. Evaluation/Acceptance of Fill Areas

All areas to receive fill, including removal and processed areas, key bottoms, and benches, shall be observed, mapped, elevations recorded, and/or tested prior to being accepted by the Geotechnical Consultant as suitable to receive fill. The contractor shall obtain a written acceptance from the Geotechnical Consultant prior to fill placement. A licensed surveyor shall provide sufficient survey control for determining locations and elevations of processed areas, keys, and benches.

C. Processing

After the ground surface to receive fill has been declared satisfactory for support of fill by the Geotechnical Consultant, it shall be scarified to a minimum depth of 6 inches and until the ground surface is uniform and free from ruts, hollows, hummocks, or other uneven features which may prevent uniform compaction.

The scarified ground surface shall then be brought to optimum moisture, mixed as required, and compacted to a minimum relative compaction of 90 percent.

D. Subdrains

Subdrainage devices shall be constructed in compliance with the ordinances of the controlling governmental agency, and/or with the recommendations of the Geotechnical Consultant. (Typical Canyon Subdrain details are given on Plate SG-1).

E. Cut/Fill & Deep Fill/Shallow Fill Transitions

In order to provide uniform bearing conditions in cut/fill and deep fill/shallow fill transition lots, the cut and shallow fill portions of the lot should be overexcavated to the depths and the horizontal limits discussed in the approved geotechnical report and replaced with compacted fill. (Typical details are given on Plate SG-7.)

STANDARD GRADING SPECIFICATIONS

IV. COMPACTED FILL MATERIAL

A. General

Materials excavated on the property may be utilized in the fill, provided each material has been determined to be suitable by the Geotechnical Consultant. Material to be used for fill shall be essentially free of organic material and other deleterious substances. Roots, tree branches, and other matter missed during clearing shall be removed from the fill as recommended by the Geotechnical Consultant. Material that is spongy, subject to decay, or otherwise considered unsuitable shall not be used in the compacted fill.

Soils of poor quality, such as those with unacceptable gradation, high expansion potential, or low strength shall be placed in areas acceptable to the Geotechnical Consultant or mixed with other soils to achieve satisfactory fill material.

B. Oversize Materials

Oversize material defined as rock, or other irreducible material with a maximum dimension greater than 12 inches in diameter, shall be taken offsite or placed in accordance with the recommendations of the Geotechnical Consultant in areas designated as suitable for rock disposal (Typical details for Rock Disposal are given on Plate SG-4).

Rock fragments less than 12 inches in diameter may be utilized in the fill provided, they are not nested or placed in concentrated pockets; they are surrounded by compacted fine grained soil material and the distribution of rocks is approved by the Geotechnical Consultant.

C. Laboratory Testing

Representative samples of materials to be utilized as compacted fill shall be analyzed by the laboratory of the Geotechnical Consultant to determine their physical properties. If any material other than that previously tested is encountered during grading, the appropriate analysis of this material shall be conducted by the Geotechnical Consultant as soon as possible.

D. Import

If importing of fill material is required for grading, proposed import material should meet the requirements of the previous section. The import source shall be given to the Geotechnical Consultant at least 2 working days prior to importing so that appropriate tests can be performed and its suitability determined.

V. FILL PLACEMENT AND COMPACTION

A. Fill Layers

Material used in the compacting process shall be evenly spread, watered, processed, and compacted in thin lifts not to exceed 6 inches in thickness to obtain a uniformly dense layer. The fill shall be placed and compacted on a horizontal plane, unless otherwise approved by the Geotechnical Consultant.

STANDARD GRADING SPECIFICATIONS

B. Moisture Conditioning

Fill soils shall be watered, dried back, blended, and/or mixed, as necessary to attain a relatively uniform moisture content at or slightly above optimum moisture content.

C. Compaction

Each layer shall be compacted to 90 percent of the maximum density in compliance with the testing method specified by the controlling governmental agency. (In general, ASTM D 1557-02, will be used.)

If compaction to a lesser percentage is authorized by the controlling governmental agency because of a specific land use or expansive soils condition, the area to received fill compacted to less than 90 percent shall either be delineated on the grading plan or appropriate reference made to the area in the soils report.

D. Failing Areas

If the moisture content or relative density varies from that required by the Geotechnical Consultant, the Contractor shall rework the fill until it is approved by the Geotechnical Consultant.

E. Benching

All fills shall be keyed and benched through all topsoil, colluvium, alluvium or creep material, into sound bedrock or firm material where the slope receiving fill exceeds a ratio of 5 horizontal to 1 vertical, in accordance with the recommendations of the Geotechnical Consultant.

VI. SLOPES

A. Fill Slopes

The contractor will be required to obtain a minimum relative compaction of 90 percent out to the finish slope face of fill slopes, buttresses, and stabilization fills. This may be achieved by either overbuilding the slope and cutting back to the compacted core, or by direct compaction of the slope face with suitable equipment, or by any other procedure that produces the required compaction.

B. Side Hill Fills

The key for side hill fills shall be a minimum of 15 feet within bedrock or firm materials, unless otherwise specified in the soils report. (See detail on Plate SG-5.)

C. Fill-Over-Cut Slopes

Fill-over-cut slopes shall be properly keyed through topsoil, colluvium or creep material into rock or firm materials, and the transition shall be stripped of all soils prior to placing fill. (see detail on Plate SG-6).

STANDARD GRADING SPECIFICATIONS

D. Landscaping

All fill slopes should be planted or protected from erosion by other methods specified in the soils report.

E. Cut Slopes

1. The Geotechnical Consultant should observe all cut slopes at vertical intervals not exceeding 10 feet.
2. If any conditions not anticipated in the preliminary report such as perched water, seepage, lenticular or confined strata of a potentially adverse nature, unfavorably inclined bedding, joints or fault planes are encountered during grading, these conditions shall be evaluated by the Geotechnical Consultant, and recommendations shall be made to treat these problems (Typical details for stabilization of a portion of a cut slope are given in Plates SG-2 and SG-3.).
3. Cut slopes that face in the same direction as the prevailing drainage shall be protected from slope wash by a non-erodible interceptor swale placed at the top of the slope.
4. Unless otherwise specified in the soils and geological report, no cut slopes shall be excavated higher or steeper than that allowed by the ordinances of controlling governmental agencies.
5. Drainage terraces shall be constructed in compliance with the ordinances of controlling governmental agencies, or with the recommendations of the Geotechnical Consultant.

VII. GRADING OBSERVATION

A. General

All cleanouts, processed ground to receive fill, key excavations, subdrains, and rock disposals must be observed and approved by the Geotechnical Consultant prior to placing any fill. It shall be the Contractor's responsibility to notify the Geotechnical Consultant when such areas are ready.

B. Compaction Testing

Observation of the fill placement shall be provided by the Geotechnical Consultant during the progress of grading. Location and frequency of tests shall be at the Consultants discretion based on field conditions encountered. Compaction test locations will not necessarily be selected on a random basis. Test locations may be selected to verify adequacy of compaction levels in areas that are judged to be susceptible to inadequate compaction.

C. Frequency of Compaction Testing

In general, density tests should be made at intervals not exceeding 2 feet of fill height or every 1000 cubic yards of fill placed. This criteria will vary depending on soil conditions and the size of the job. In any event, an adequate number of field density tests shall be made to verify that the required compaction is being achieved.

STANDARD GRADING SPECIFICATIONS

VIII. CONSTRUCTION CONSIDERATIONS

- A. Erosion control measures, when necessary, shall be provided by the Contractor during grading and prior to the completion and construction of permanent drainage controls.
- B. Upon completion of grading and termination of observations by the Geotechnical Consultant, no further filling or excavating, including that necessary for footings, foundations, large tree wells, retaining walls, or other features shall be performed without the approval of the Geotechnical Consultant.
- C. Care shall be taken by the Contractor during final grading to preserve any berms, drainage terraces, interceptor swales, or other devices of permanent nature on or adjacent to the property.

S:\BOILERS-WORK\REPORT INSERTS\STANDARD GRADING SPECS

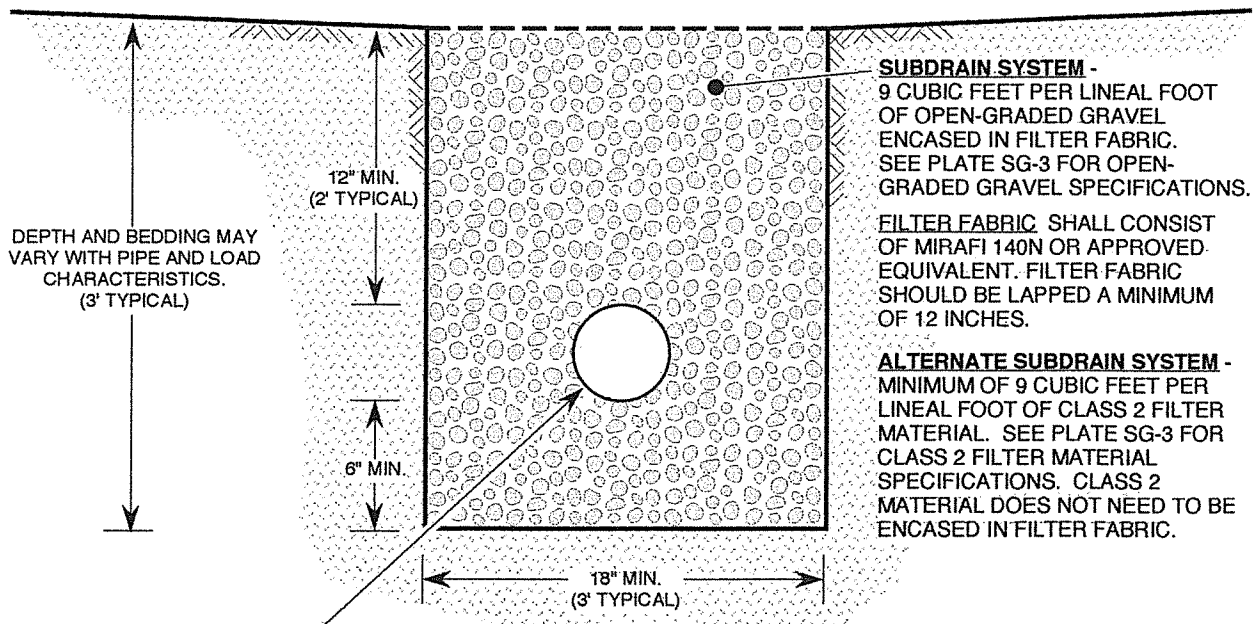
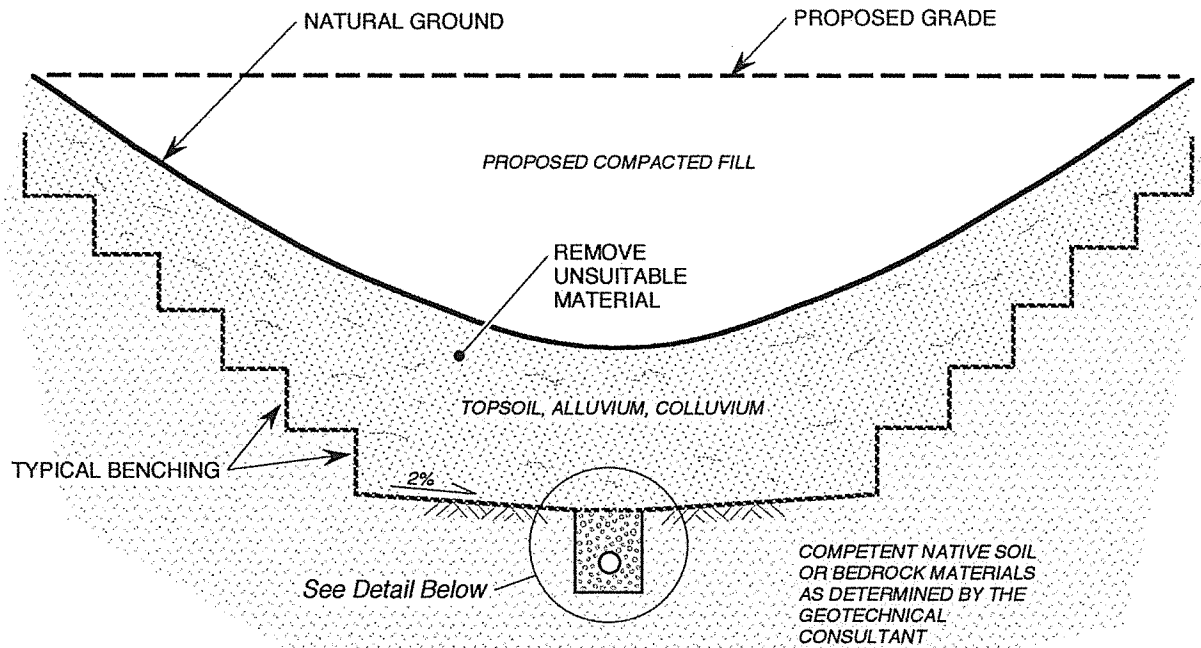

MINIMUM 6-INCH DIAMETER PVC SCHEDULE 40, OR ABS SDR-35 WITH A MINIMUM OF EIGHT 1/4-INCH DIAMETER PERFORATIONS PER LINEAL FOOT IN BOTTOM HALF OF PIPE. PIPE TO BE LAID WITH PERFORATIONS FACING DOWN.

NOTES:

1. FOR CONTINUOUS RUNS IN EXCESS OF 500 FEET USE 8-INCH DIAMETER PIPE.
2. FINAL 20 FEET OF PIPE AT OUTLET SHALL BE NON-PERFORATED AND BACKFILLED WITH FINE-GRAINED MATERIAL.

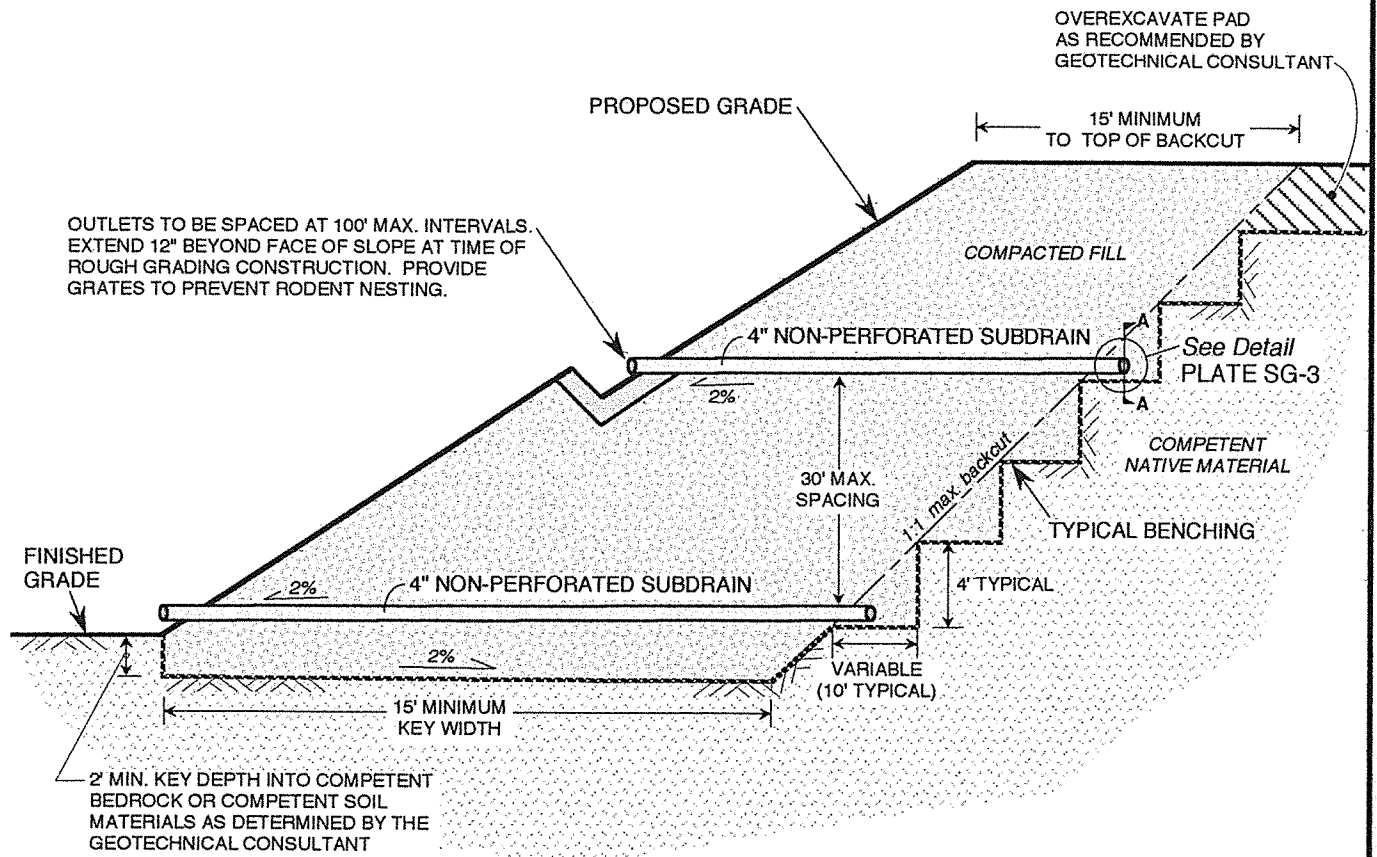

NOTES:

1. 30' MAXIMUM VERTICAL SPACING BETWEEN SUBDRAIN SYSTEMS.
2. 100' MAXIMUM HORIZONTAL DISTANCE BETWEEN NON-PERFORATED OUTLET PIPES. (See Below)
3. MINIMUM GRADIENT OF 2% FOR ALL PERFORATED AND NON-PERFORATED PIPE.

SECTION A-A (PERFORATED PIPE PROFILE)

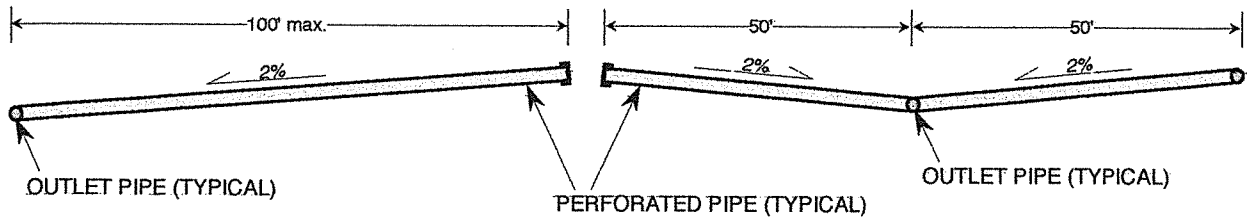

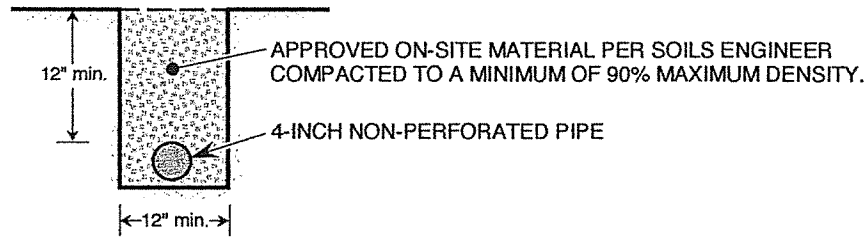
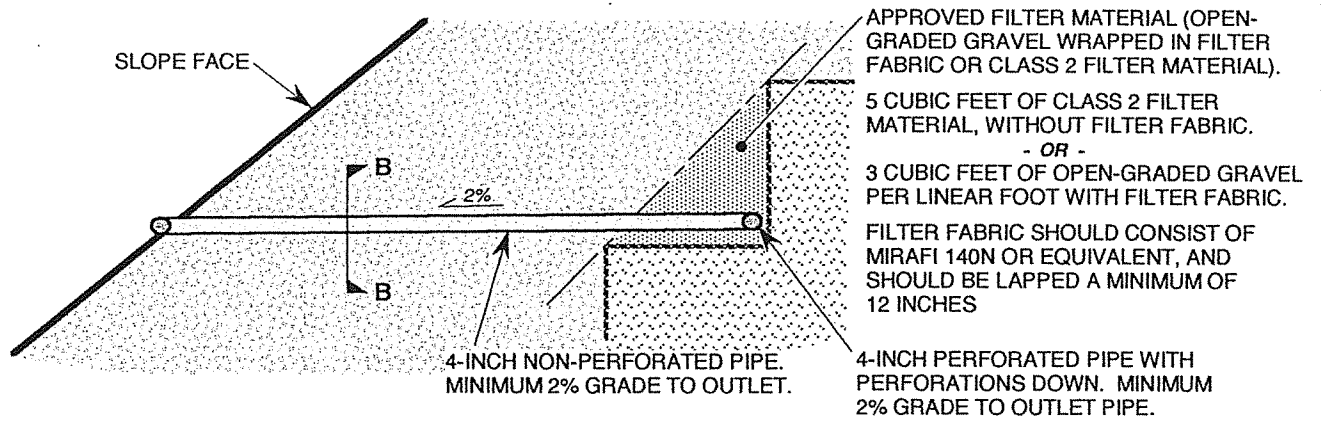

SECTION B-B (OUTLET PIPE)

PIPE SPECIFICATIONS:

1. 4-INCH MINIMUM DIAMETER, PVC SCHEDULE 40 OR ABS SDR-35.
2. FOR PERFORATED PIPE, MINIMUM 8 PERFORATIONS PER FOOT ON BOTTOM HALF OF PIPE.

FILTER MATERIAL/FABRIC SPECIFICATIONS:

OPEN-GRADED GRAVEL ENCASED IN FILTER FABRIC.
(MIRAFI 140N OR EQUIVALENT)

OPEN-GRADED GRAVEL

SIEVE SIZE	PERCENT PASSING
1 1/2-INCH	88 - 100
1-INCH	5 - 40
3/4-INCH	0 - 17
3/8-INCH	0 - 7
No. 200	0 - 3

ALTERNATE:

CLASS 2 PERMEABLE FILTER MATERIAL PER CALTRANS
STANDARD SPECIFICATION 68-1.025.

CLASS 2 FILTER MATERIAL

SIEVE SIZE	PERCENT PASSING
1-INCH	100
3/4-INCH	90 - 100
3/8-INCH	40 - 100
No. 4	25 - 40
No. 8	18 - 33
No. -30	5 - 15
No. -50	0 - 7
No. 200	0 - 3

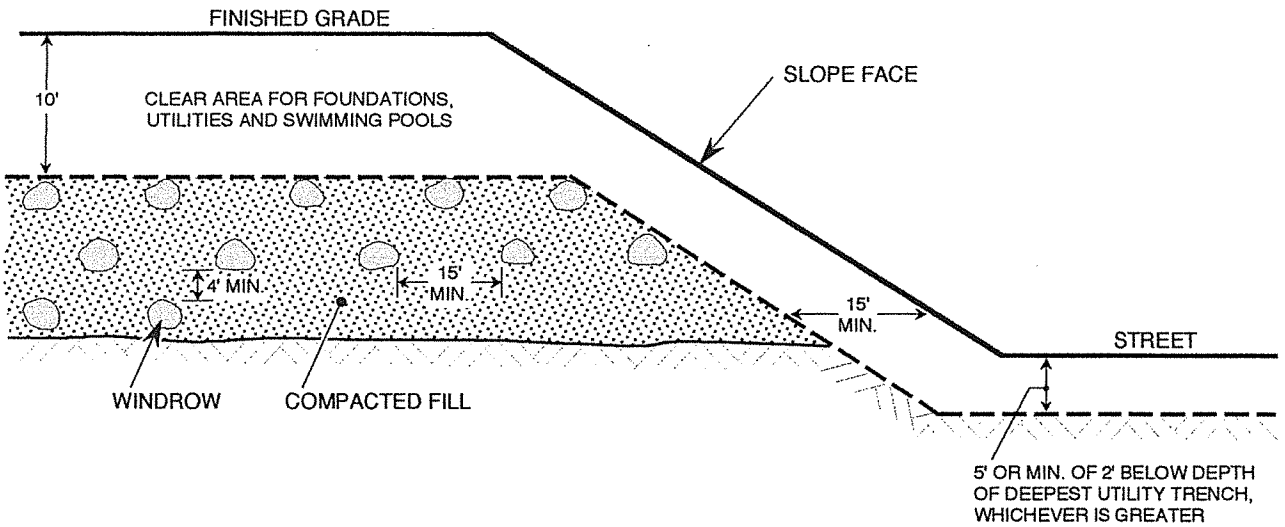

TYPICAL WINDROW DETAIL (END VIEW)

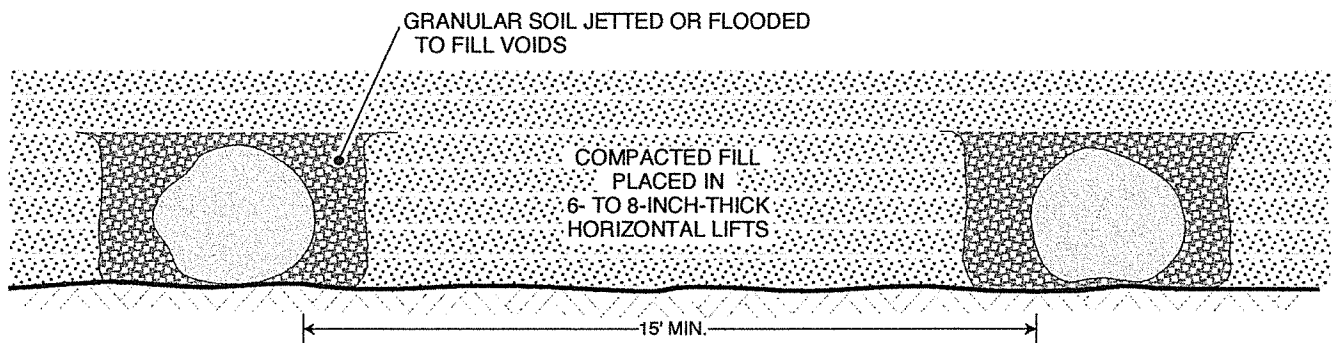

TYPICAL WINDROW DETAIL (PROFILE VIEW)

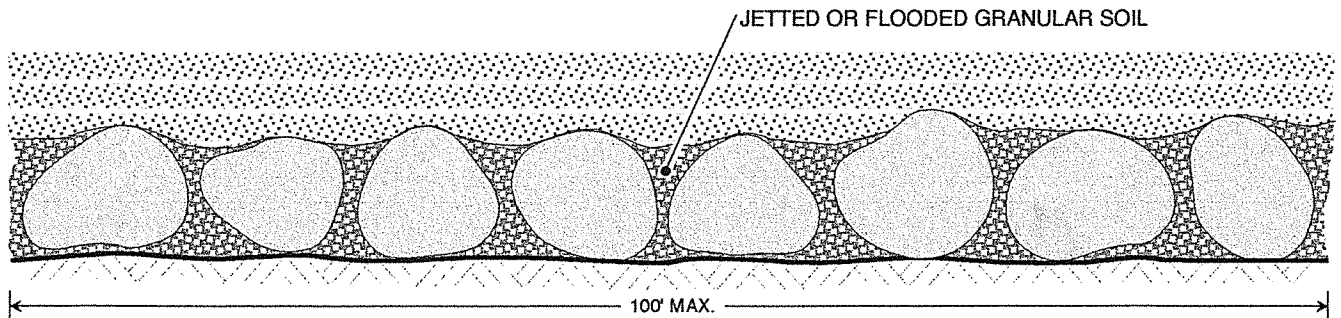

NOTE: OVERSIZE ROCK IS DEFINED AS CLASTS HAVING A MAXIMUM DIMENSION OF 12" OR LARGER

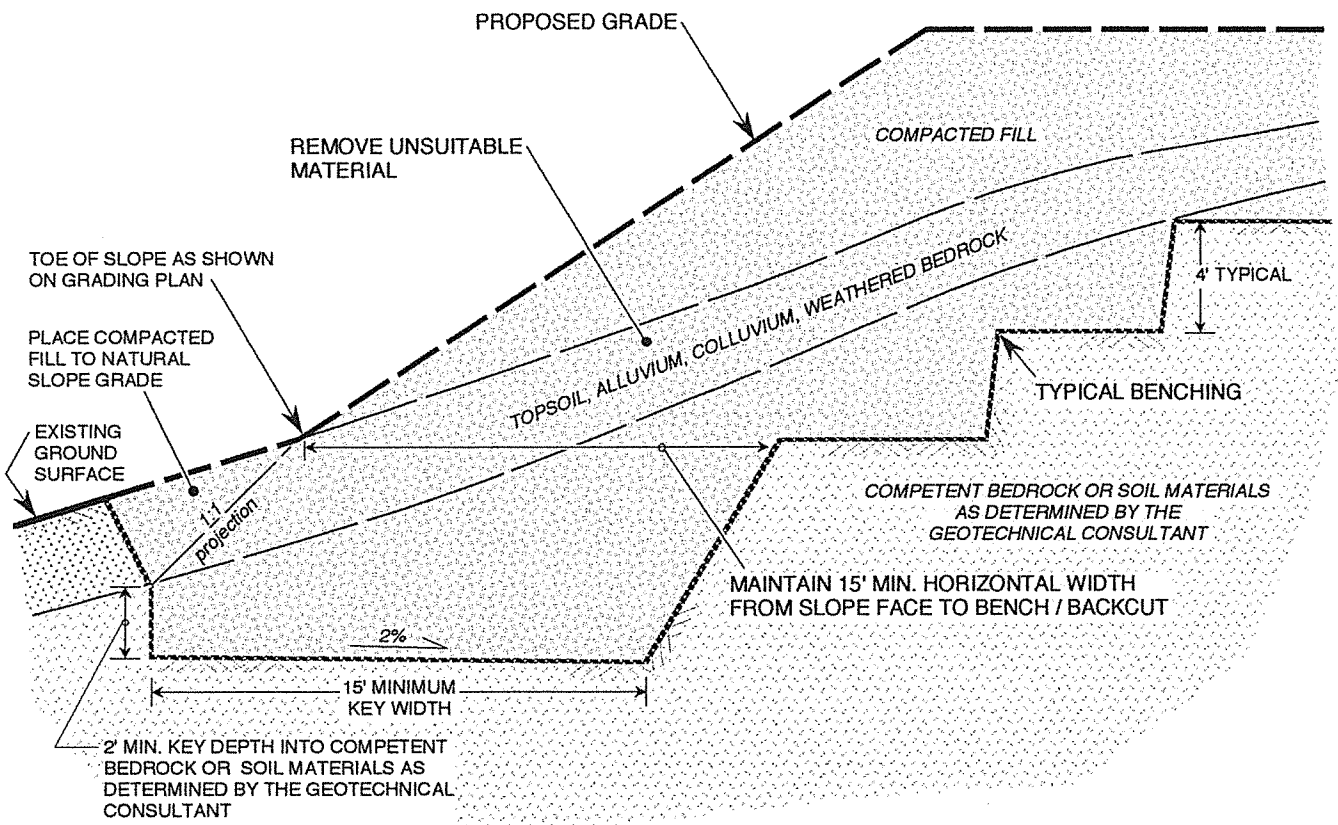

NOTES:

1. WHERE NATURAL SLOPE GRADIENT IS 5:1 OR LESS, BENCHING IS NOT NECESSARY; HOWEVER, FILL IS NOT TO BE PLACED ON COMPRESSIBLE OR UNSUITABLE MATERIAL.
2. SOILS ENGINEER TO DETERMINE IF SUBDRAIN IS REQUIRED.

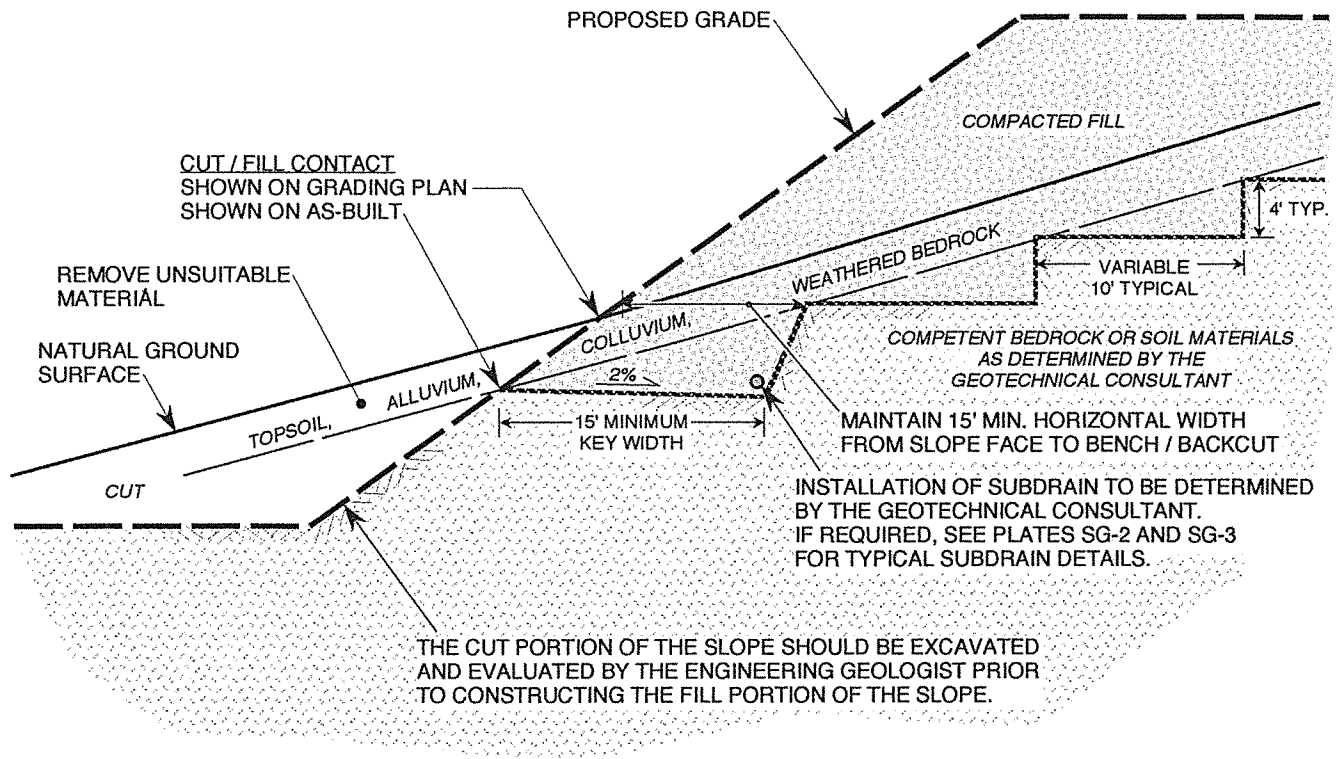

CUT LOT

UNSUITABLE MATERIAL EXPOSED IN PORTION OF CUT PAD

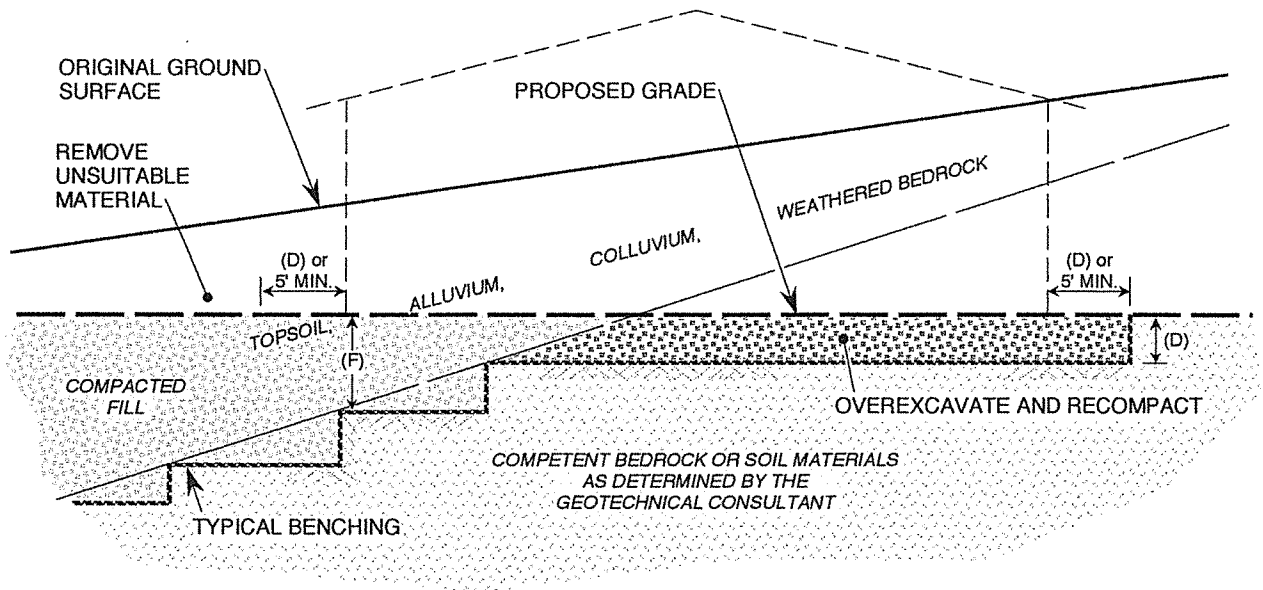

CUT-FILL TRANSITION LOT

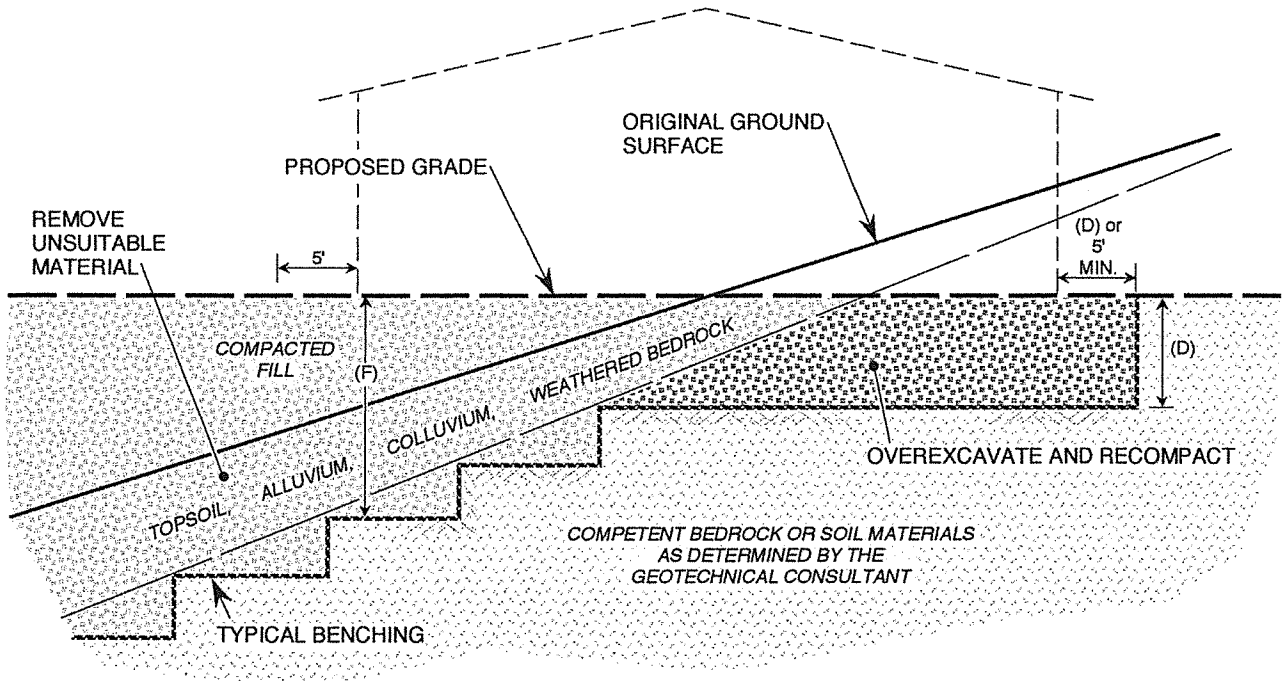

MAXIMUM FILL THICKNESS (F)

FOOTING DEPTH TO 3 FEET

3 TO 6 FEET

GREATER THAN 6 FEET

DEPTH OF OVEREXCAVATION (D)

EQUAL DEPTH

3 FEET

1/2 THE THICKNESS OF DEEPEST FILL PLACED WITHIN THE "FILL" PORTION (F) TO 15 FEET MAXIMUM

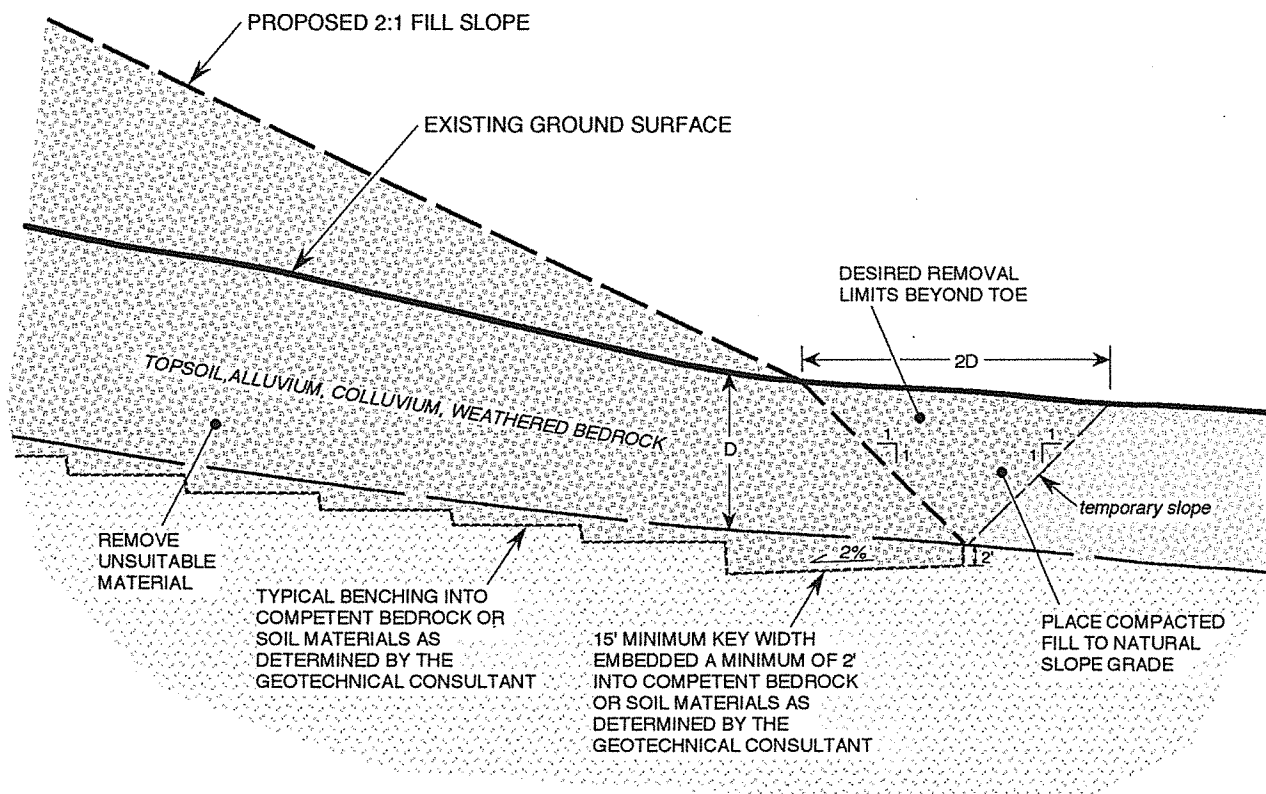

D = RECOMMENDED DEPTH OF REMOVAL PER GEOTECHNICAL REPORT

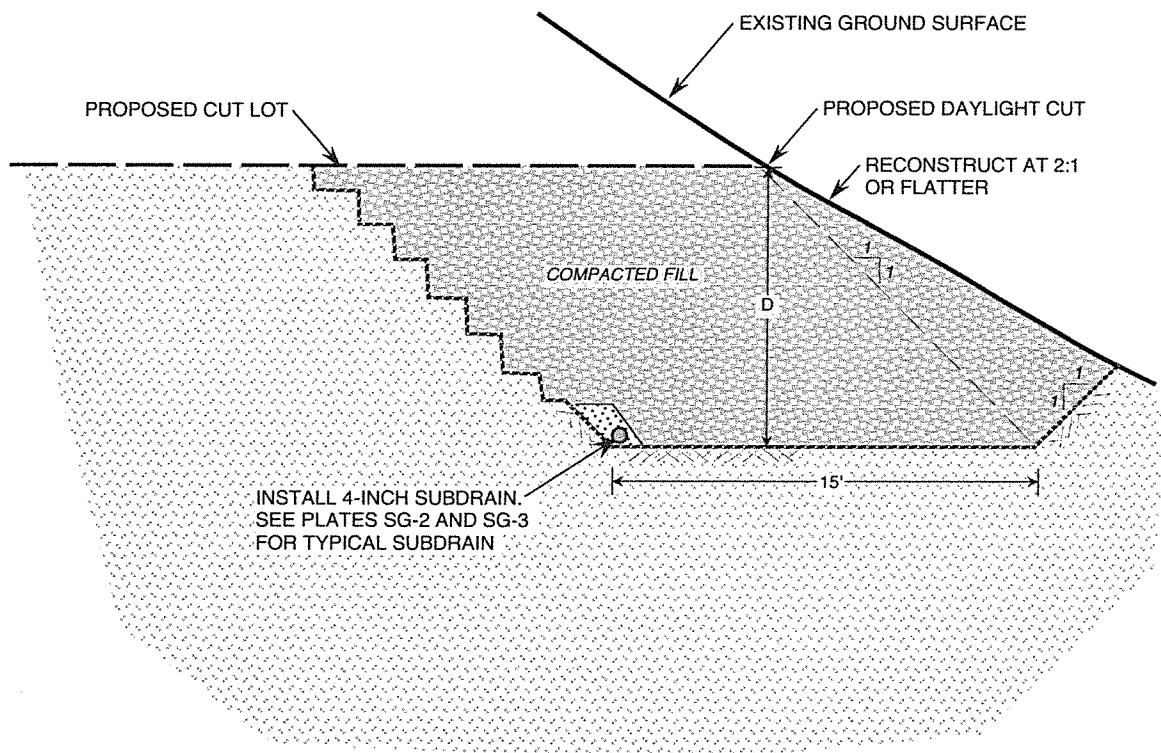

NOTE:

1. "D" SHALL BE 10 FEET MINIMUM OR AS DETERMINED BY SOILS ENGINEER.