

1164

16
14
12
110
08
06
04
02
1100

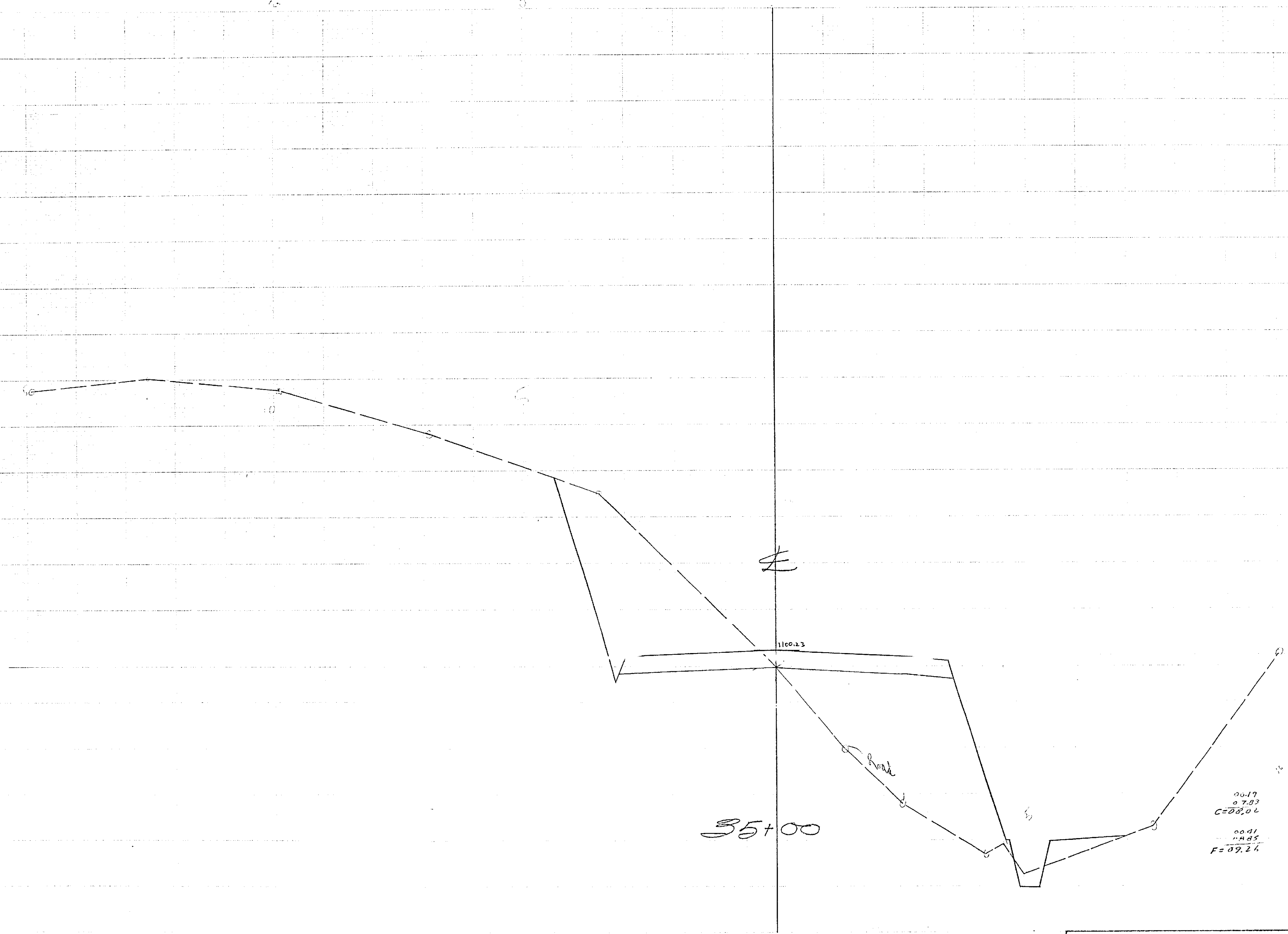

1100
1098
96
94
92
1090
88

Scale Vert. 1"=2'
Hor. 1"=10'

CITY OF RIVERSIDE		SCALE	DATE 1-63	ALBERT A. WEBB ASSOCIATES	W.C. 60-115
CROSS SECTIONS		DRAWN		CIVIL ENGINEERS	SHEET 34
ARLINGTON AVENUE BETWEEN		TRACED		RIVERSIDE CALIFORNIA	OF SHEETS
VICTORIA AVE. & ALESSANDRO BLVD.		CHECKED			DWG. NO.
		F.B.			

1164

1164

1164

18
16
14
12
110
08
06
04
02
100
1098

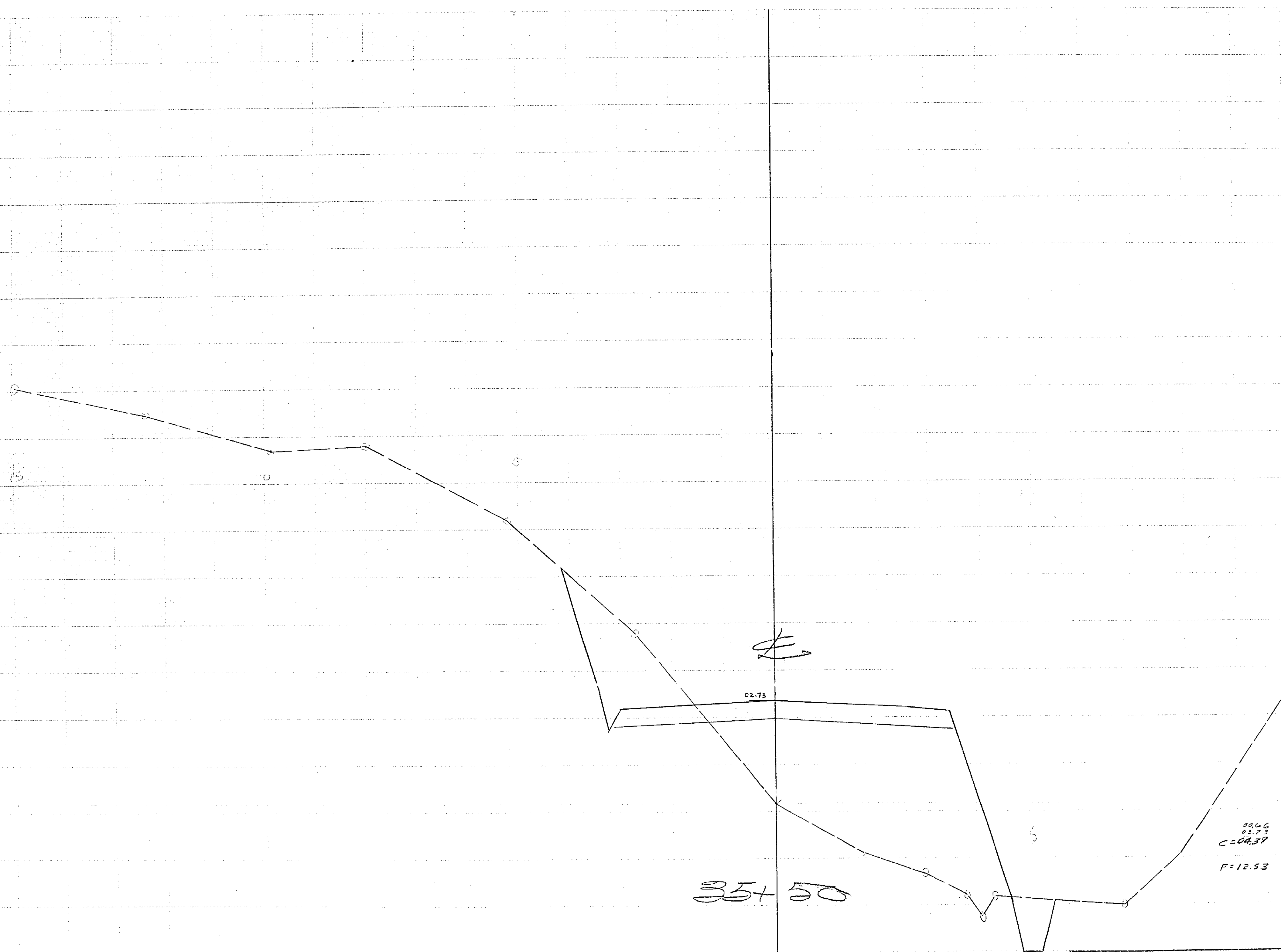

1098
96
94
92

Scale Vert. 1"=2'
Hor. 1"=10'

CITY OF RIVERSIDE
 CROSS SECTIONS
 ARLINGTON AVENUE BETWEEN
 VICTORIA AVE. & ALESSANDRO BLVD

SCALE	DATE 7-63	W.O. 60115
DRAWN	ALBERT A. WEBB ASSOCIATES CIVIL ENGINEERS	SHEET 35
TRACED	RIVERSIDE	OF SHEETS
CHECKED	ILLINOIS	1164
P.S.		DWG. NO.

1164

1164

24
22
1120
18
16
14
12
110
08
06
1107

1104
02
1100
1098
96

36+00

00.82
0.215
C=03.10
00.13
01.21
E=07.54

Scale Vert. 1"=2'
Hor. 1"=10'

CITY OF RIVERSIDE		SCALE	W.O. 60-115
CROSS SECTIONS		DATE 1-63	SHEET 36
ARLINGTON AVENUE BETWEEN		DRAWN	OF SHEETS
VICTORIA AVE & ALESSANDRO BLVD.		TRACED	DWG. NO.
		CHECKED	
		FR	
		ALBERT A. WEBB ASSOCIATES CIVIL ENGINEERS RIVERSIDE CALIFORNIA	

1164

1164

1164

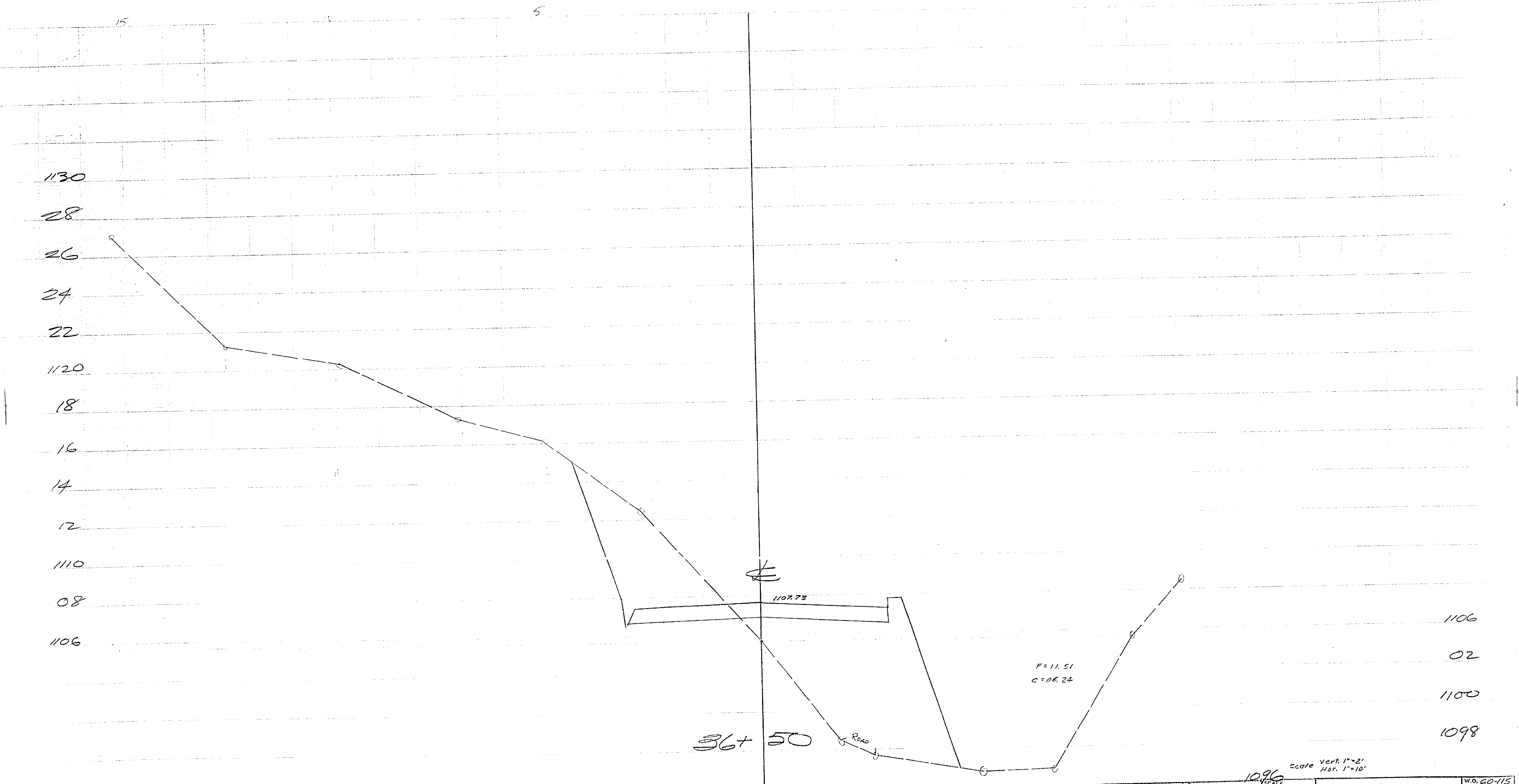

CITY OF RIVERSIDE		DATE 1-63	ALBERT A. WEBB ASSOCIATES CIVIL ENGINEERS	W.O. 60-115
CROSS SECTIONS		DRAWN	RIVERSIDE CALIFORNIA	SHEET 37
ARLINGTON AVENUE BETWEEN VICTORIA AVE. FALESSANDRO BLVD.		TRACED		OF SHEETS
		CHECKED		DWG. NO.
		P.R.		

1096
1164

1164

1164

15

20

5

5

10

15

34

32

1130

28

26

24

22

1120

18

16

14

12

1110

08

1106

04

02

1100

1098

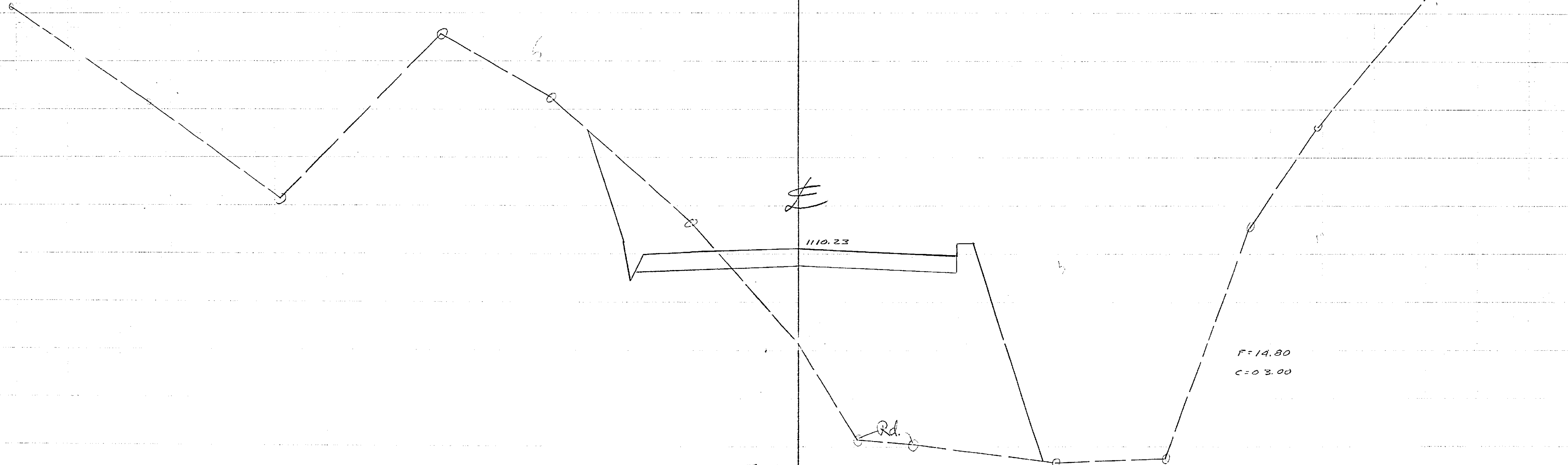

Scale Vert. 1"=2'
Hor. 1"=10'

CITY OF RIVERSIDE		SCALE	ALBERT A. WEBB ASSOCIATES	W.O. 60-115
CROSS SECTIONS		DATE 1-63	CIVIL ENGINEERS	SHEET 38
ARLINGTON AVENUE BETWEEN		DRAWN	RIVERSIDE	OF SHEETS
VICTORIA AVE. & ALESSANDRO BLVD.		TRACED	CALIFORNIA	DWG. NO.
		CHECKED		
		F.S.		

1164

1164

1164

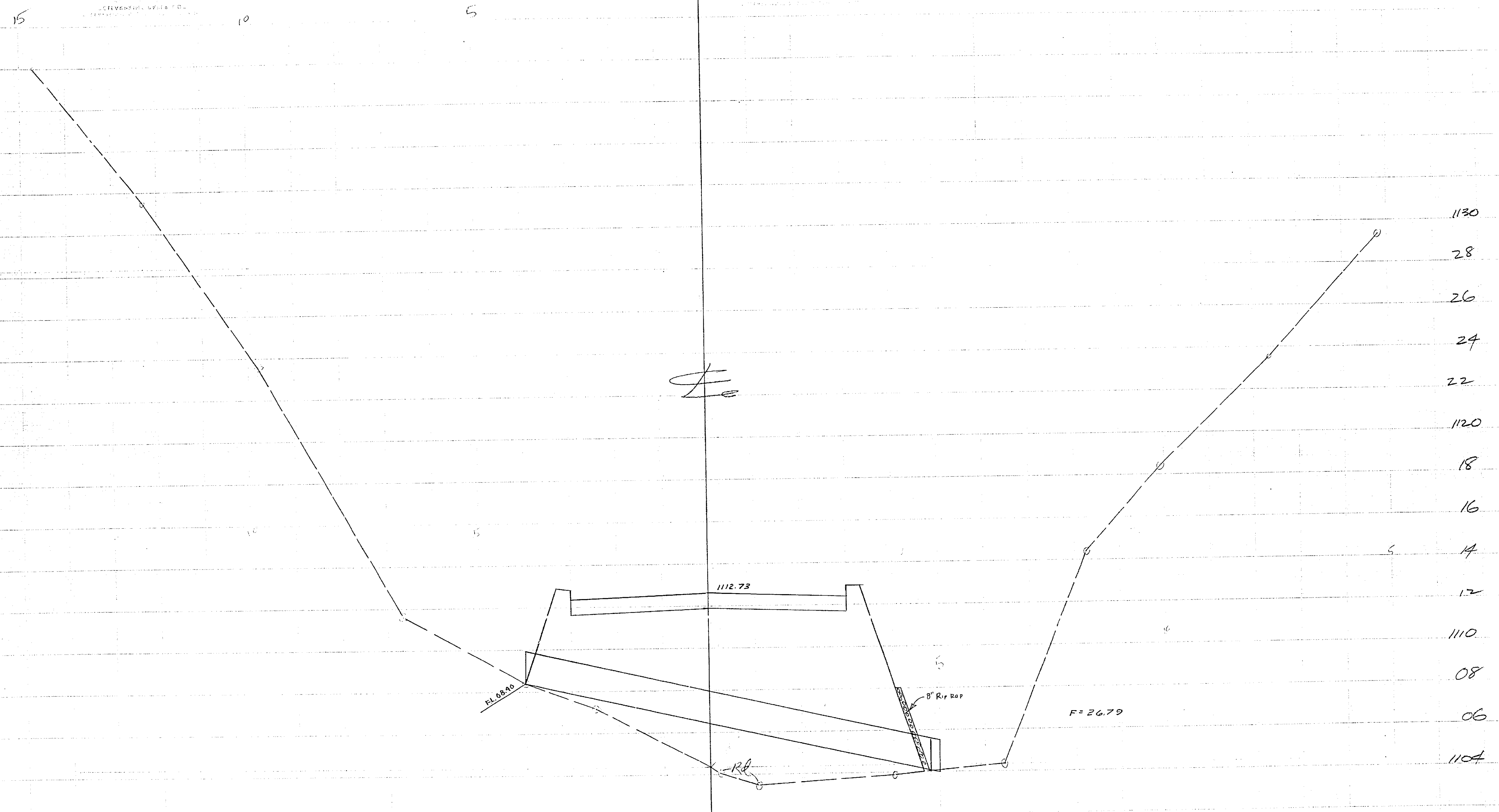

1164

CITY OF RIVERSIDE
 CROSS SECTIONS
 ARLINGTON AVENUE BETWEEN
 VICTORIA AVE. & ALESSANDRO BLVD.

SCALE	DATE 7-63	ALBERT A. WEBB ASSOCIATES	W.O. 60-115
DRAWN		CIVIL ENGINEERS	SHEET 39
CHECKED		RIVERSIDE	OF SHEETS
F.B.		1164	DWG. NO.

1164

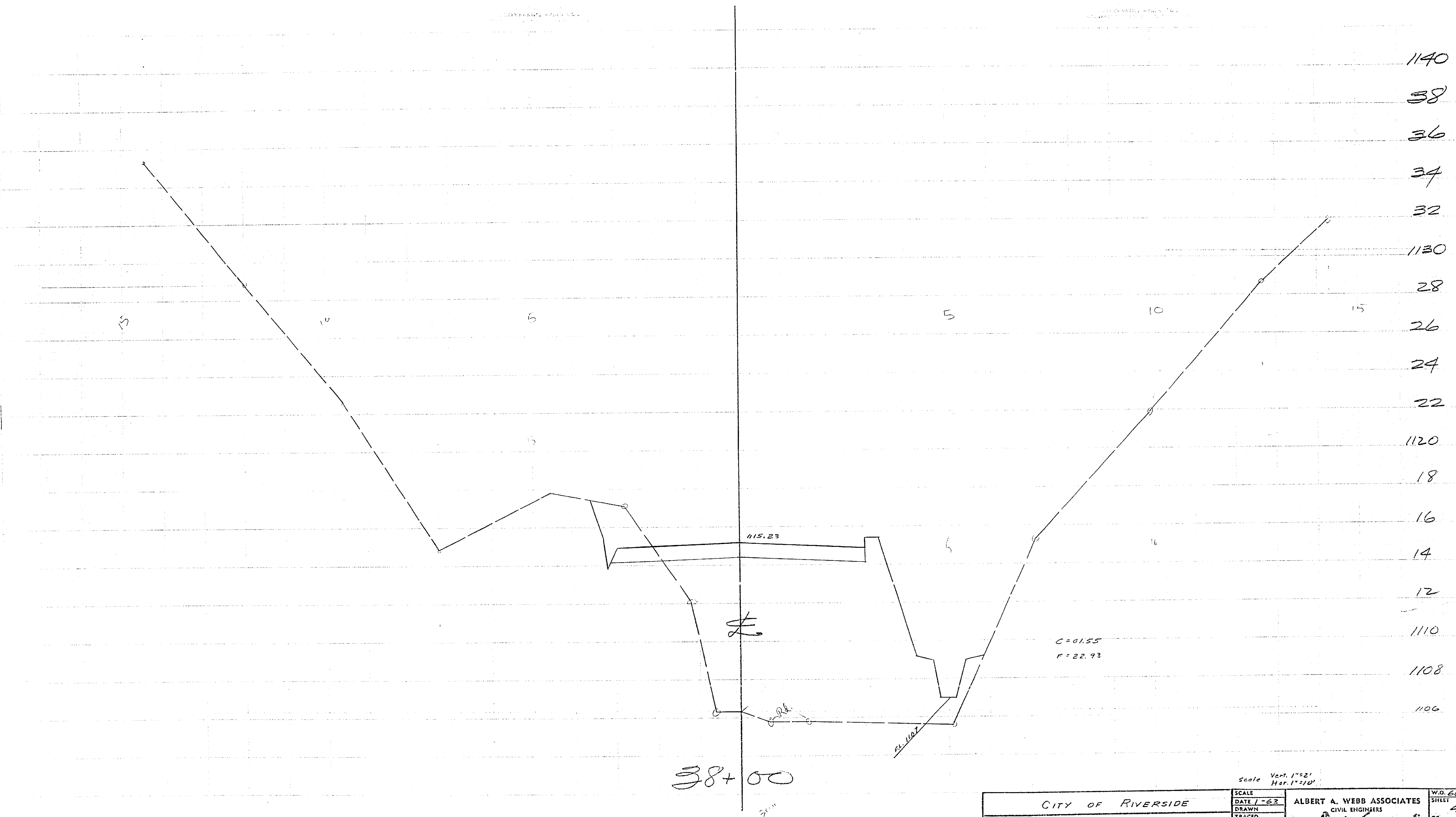

1164

CITY OF RIVERSIDE		SCALE	Vert. 1"=2'	Hor. 1"=20'
CROSS SECTIONS		DATE	1-63	
ARLINGTON AVENUE BETWEEN		DRAWN		
VICTORIA AVE. & ALESSANDRO BLVD.		TRACED		
		CHECKED		
		F.B.		
ALBERT A. WEBB ASSOCIATES			W.O. 60-115	
CIVIL ENGINEERS			STREET	40
RIVERSIDE CALIFORNIA			OF SHEETS	
			DWG. NO.	

1164

1164

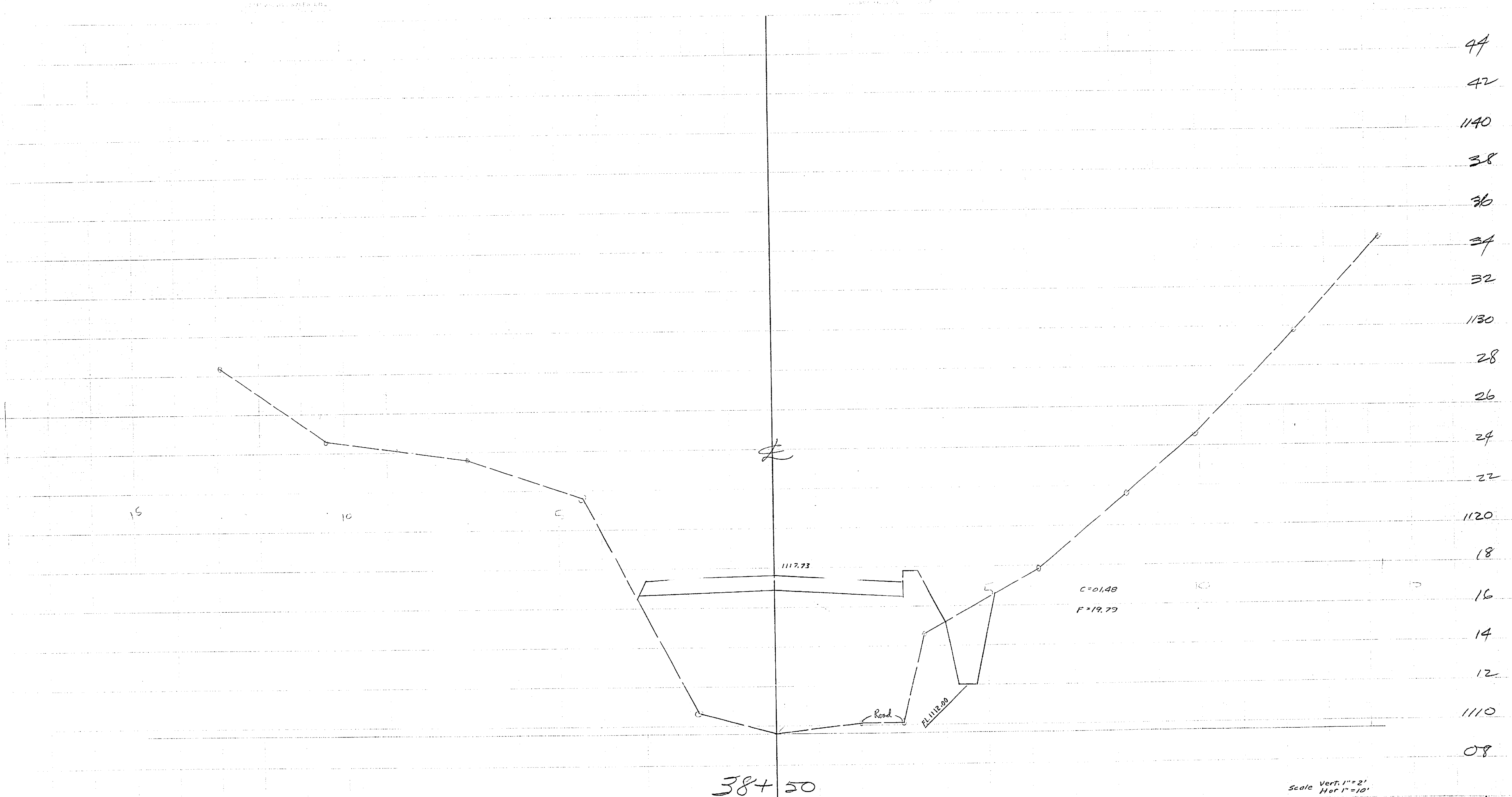

384.50

CITY OF RIVERSIDE
 CROSS SECTIONS
 ARLINGTON AVENUE BETWEEN
 VICTORIA AVE. & ALESSANDRO BLVD.

Scale Vert. 1"=2'
 Hor 1"=10'

SCALE	DATE 1-63	ALBERT A. WEBB ASSOCIATES CIVIL ENGINEERS	W.D. 60-1151
DRAWN			SHEET 41
TRACED			OF SHEETS
CHECKED		RIVERSIDE CALIFORNIA	DWG. NO.
E.E.		1164	

1164

1164

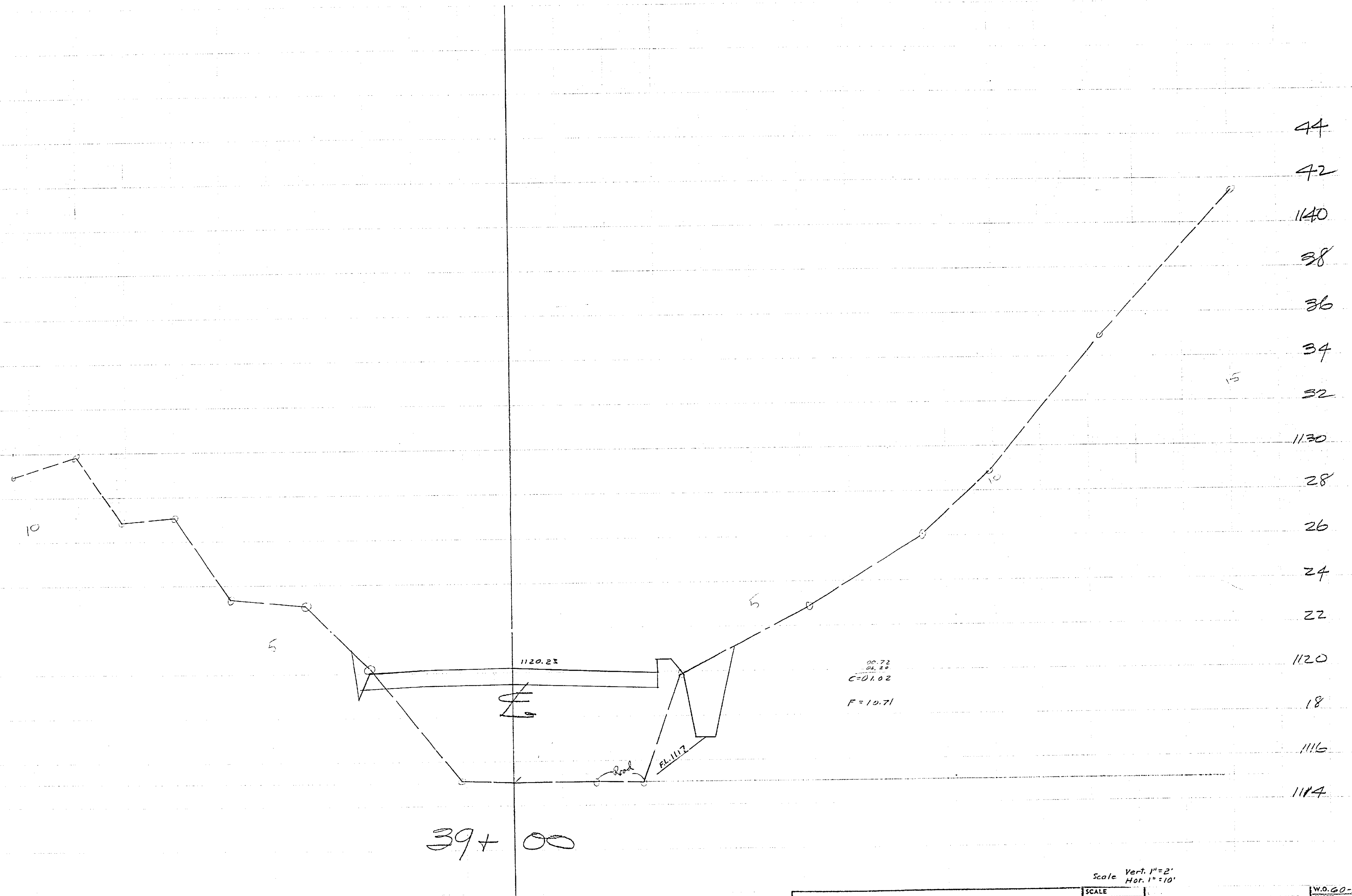

39+00

CITY OF RIVERSIDE		ALBERT A. WEBB ASSOCIATES CIVIL ENGINEERS		W.O. 60-115
SCALE	DATE 1-63	RIVERSIDE, CALIFORNIA		SHEET 42
CROSS SECTIONS		1164		OF SHEETS
ARLINGTON AVENUE BETWEEN VICTORIA AVE. & ALESSANDRO BLVD.				DWG. NO.
DRAWN	CHECKED			
TRACED	P.B.			

1164

1164

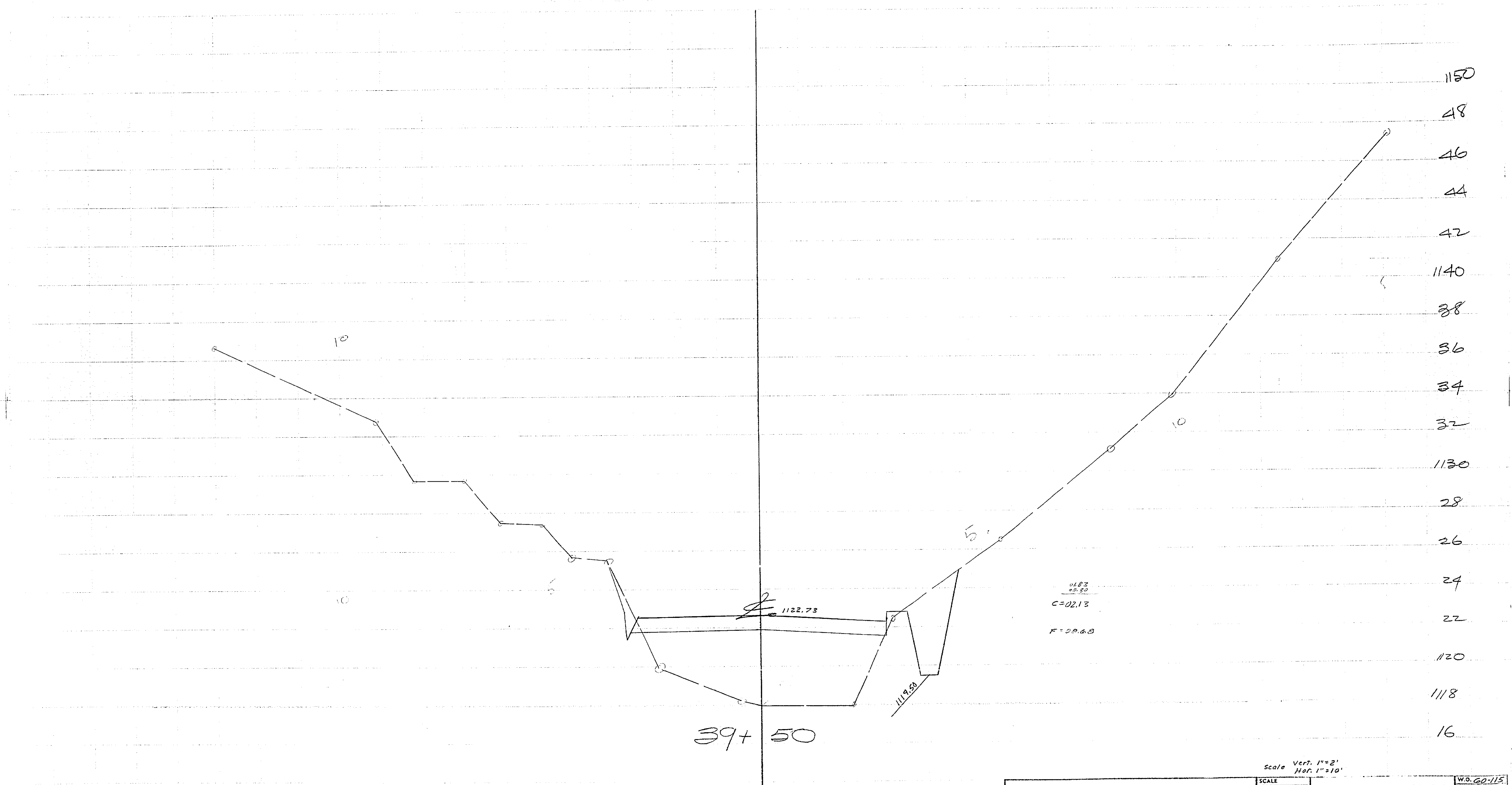

1164

CITY OF RIVERSIDE		SCALE	Ver. 1"=2'	W.O. 60-115
CROSS SECTIONS		DATE	1-63	STREET
ARLINGTON AVENUE BETWEEN		DRAWN		43
VICTORIA AVE. & ALESSANDRO BLVD.		TRACED		OF SHEETS
		CHECKED		1164
		F.R.		OF DWG. NO.

ALBERT A. WEBB ASSOCIATES
CIVIL ENGINEERS
RIVERSIDE CALIFORNIA

1164

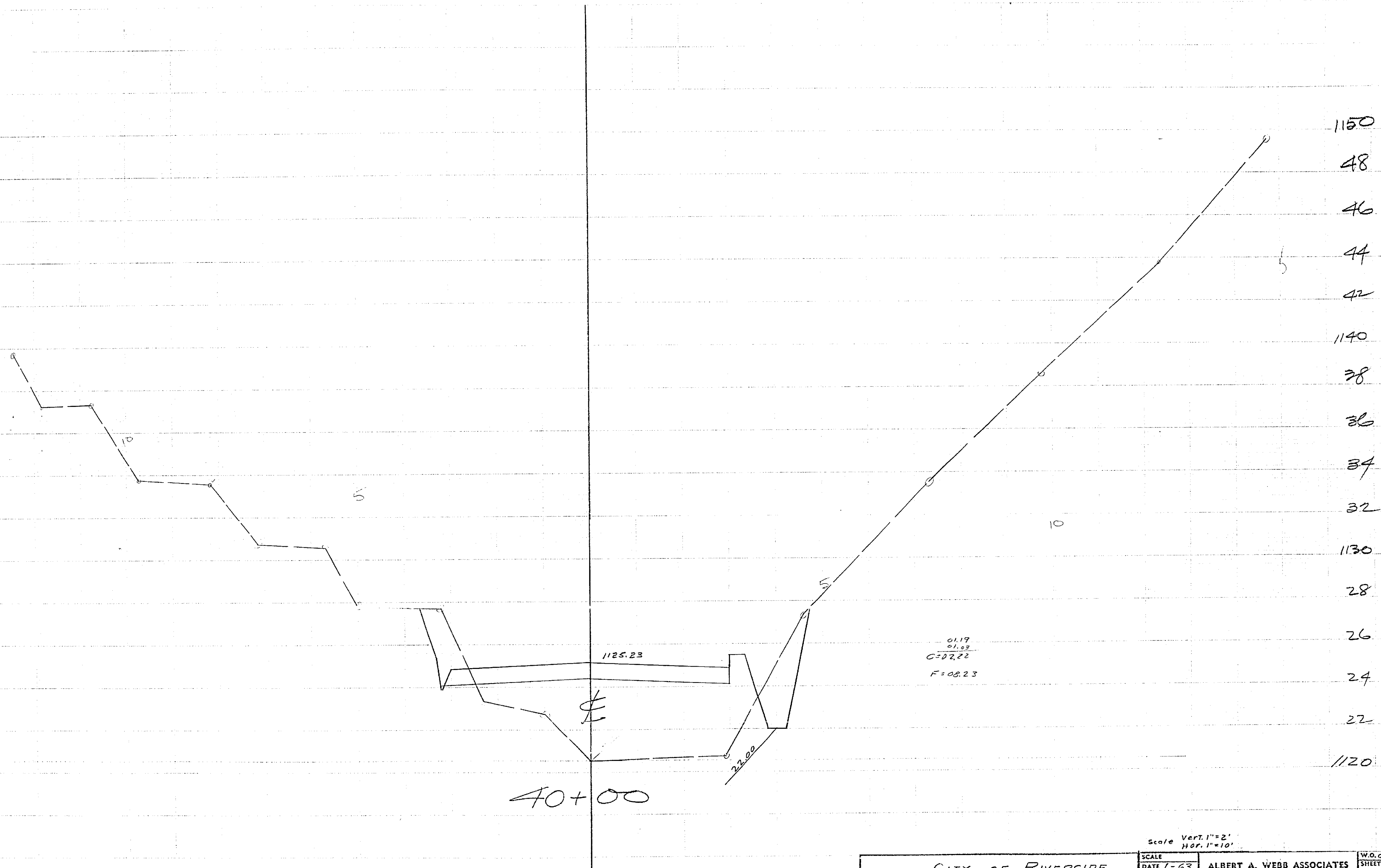

CITY OF RIVERSIDE
 CROSS SECTIONS
 ARLINGTON AVENUE BETWEEN
 VICTORIA AVE & ALESSANDRO BLVD.

Scale Vert. 1"=2'
 Hor. 1"=10'

SCALE	DATE 1-63	ALBERT A. WEBB ASSOCIATES	W.O. 60-115
DRAWN		CIVIL ENGINEERS	SHEET 44
TRACED			OF SHEETS
CHECKED		RIVERSIDE	DWG. NO.
F.B.			

1164

1164

1164

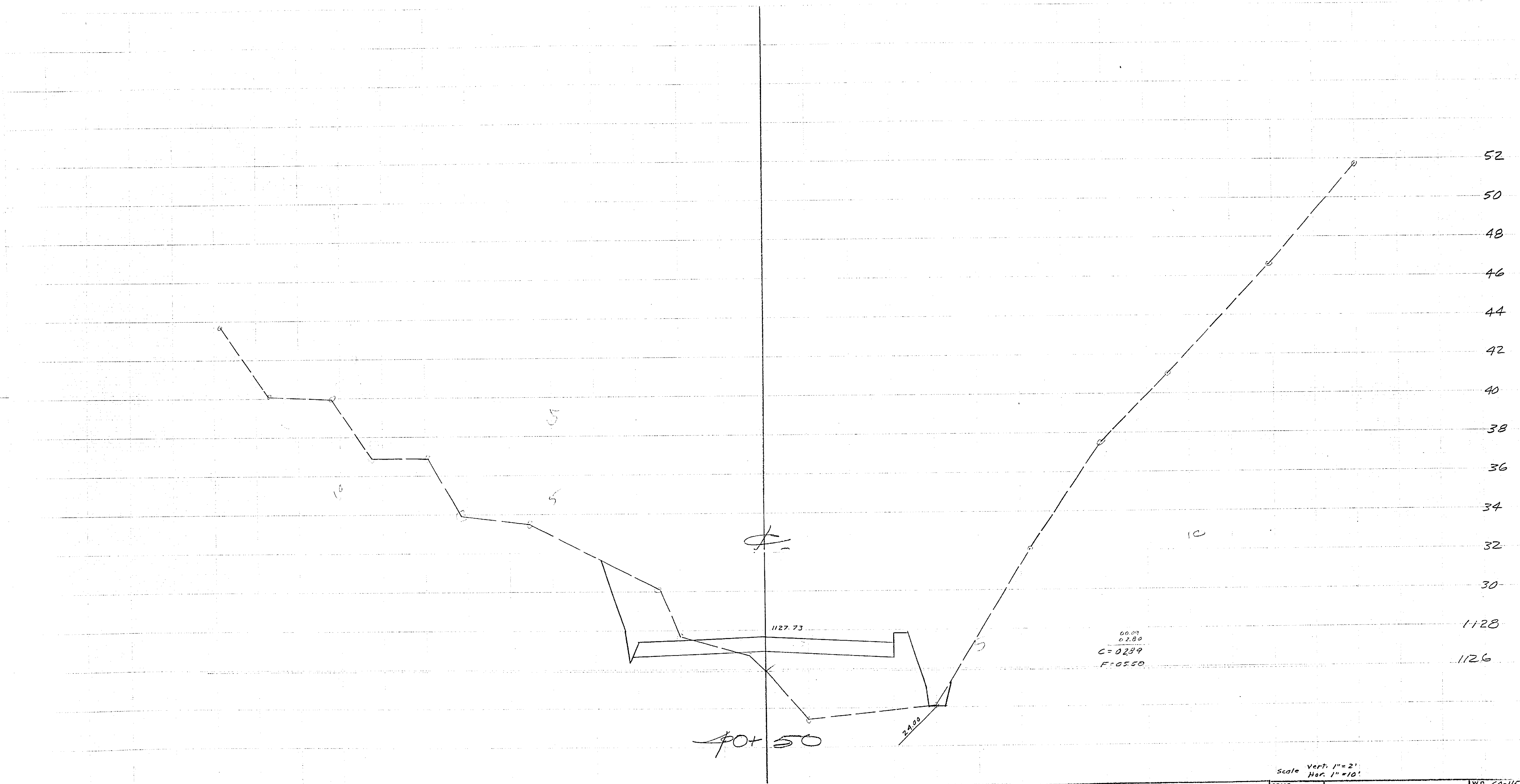

CITY OF RIVERSIDE		SCALE	DATE	ALBERT A. WEBB ASSOCIATES	W.O. 60-115
CROSS SECTIONS		1" = 2'	7-63	CIVIL ENGINEERS	SHEET 45
ARLINGTON AVENUE BETWEEN		DRAWN			OF SHEETS
VICTORIA AVE & ALESSANDRO BLD.		TRACED			DWG. NO.
		CHECKED		RIVERSIDE CALIFORNIA	
		F.B.			

1164

1164

1164

ALBERT A. WEBB ASSOCIATES
ENGINEERS

DATE 7-63

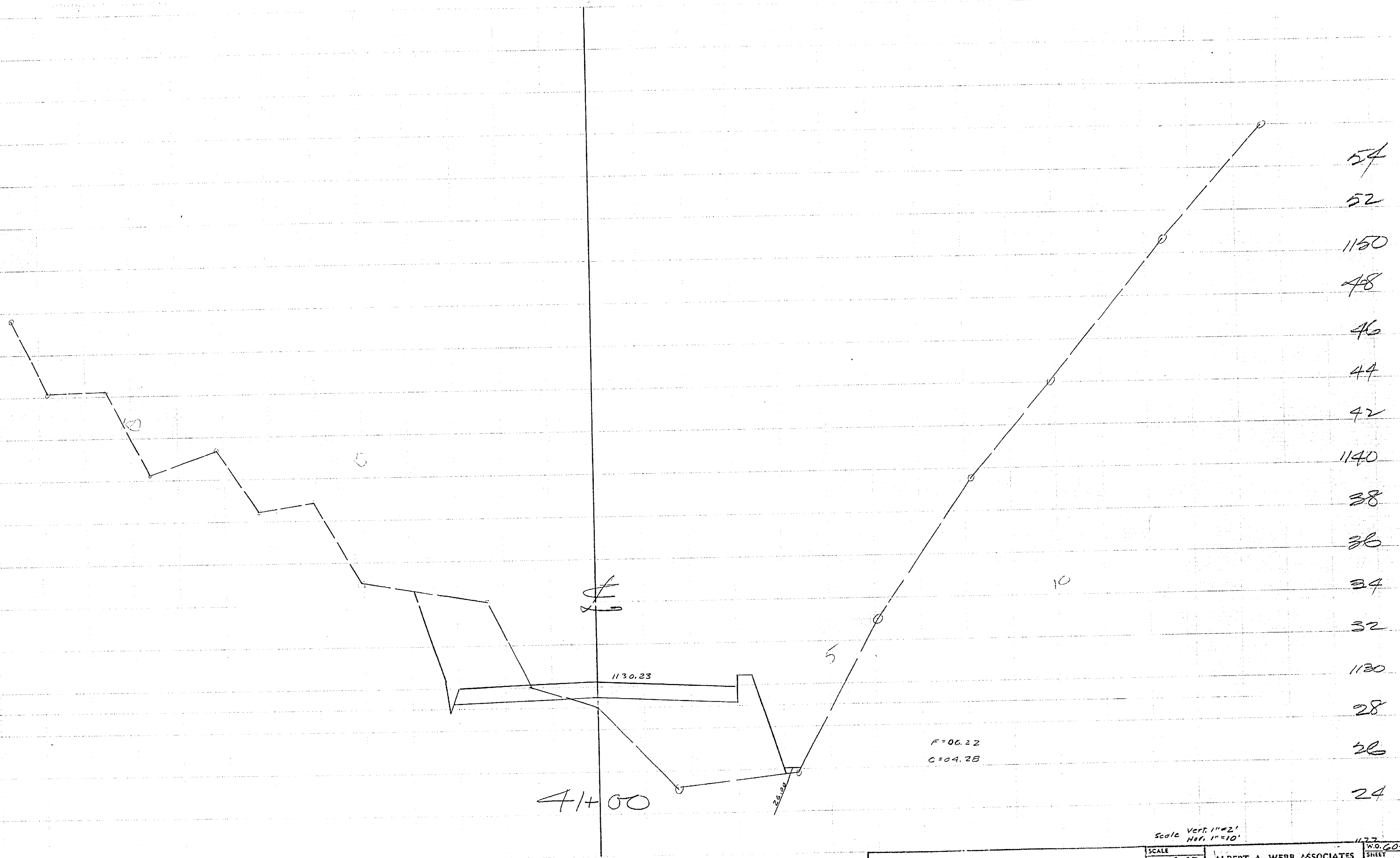

54
52
1150
48
46
44
42
1140
38
36
34
32
1130
28
26
24

CITY OF RIVERSIDE
CROSS SECTIONS
ARLINGTON AVENUE BETWEEN
VICTORIA AVE. & ALESSANDRO BLVD.

Scale Vert. 1"=2'
Hor. 1"=10'

SCALE	ALBERT A. WEBB ASSOCIATES	1175
DATE 7-63	CIVIL ENGINEERS	NO. 60-115
DRAWN		SHEET 40
TRACED		OF SHEETS
CHECKED	RIVERSIDE	DWG. NO.
F.S.	1164	

1164

1164



Scale Ver 1" = 2'
Hor 1" = 10'

CITY OF RIVERSIDE		W.G. 60-115
SCALE	DATE 1-63	SHEET 47
DRAWN	ALBERT A. WEBB ASSOCIATES CIVIL ENGINEERS	
TRACED	RIVERSIDE CALIFORNIA	
CHECKED	OF SHEETS	
P.B.	DWG. NO.	

1164

1164

1167

1156 1154 1152 1150 1148 1146 1144 1152 1154 1156 1158 1160 1162 1164 1166 1168 1170 1172 1156 1158 1160 1152 1154 1156 1158 1160 1162 1164 1166 1168 1170 1172

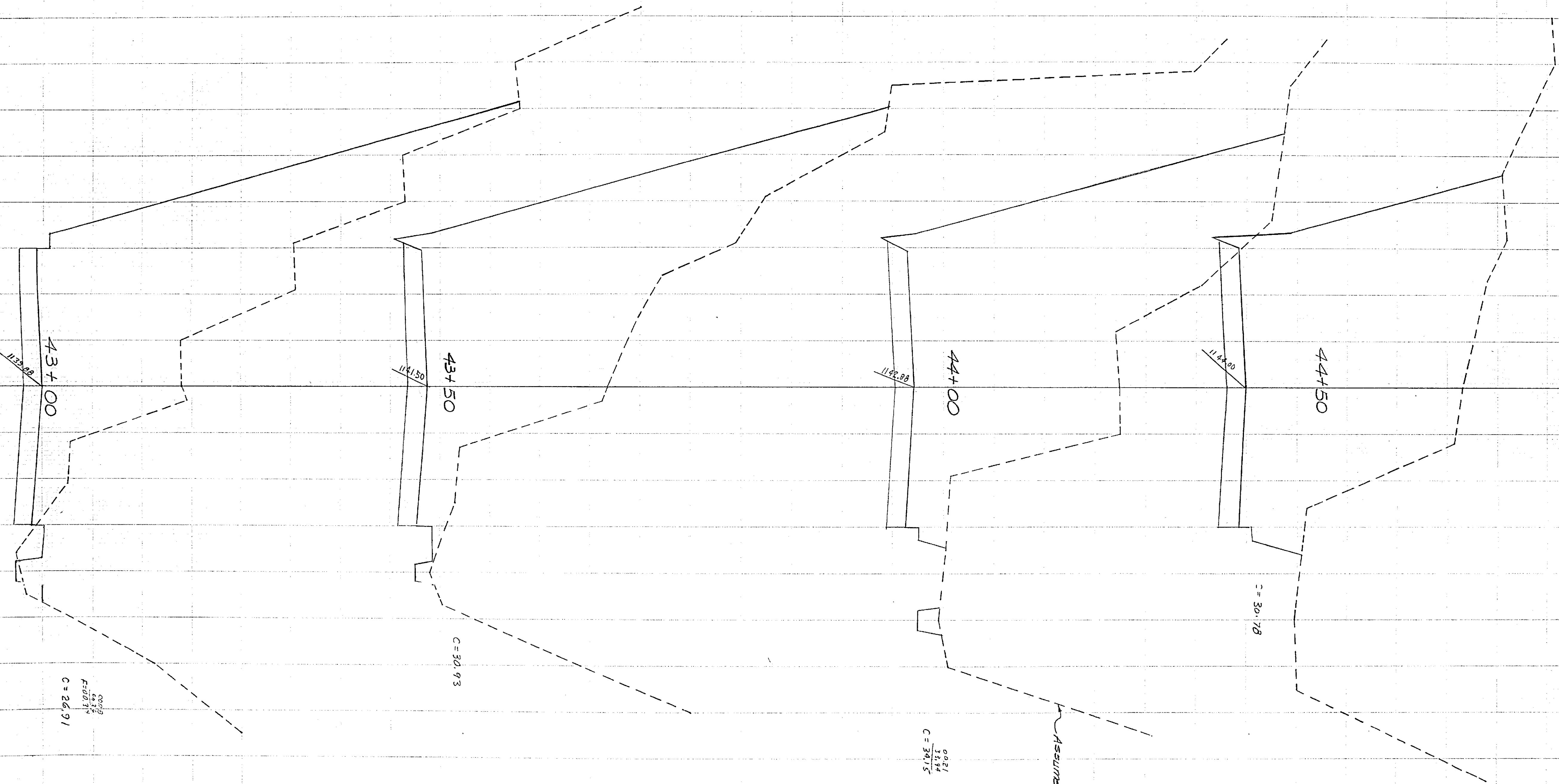

0009
3.5
#5021
C = 267.91

C = 301.93

0021
3.44
#4
C = 347.5

ASSUMED

C = 301.78

1140 1142 1144 1146 1148

1140 1142 1144

1146 1148 1150 1152

1142 1144 1146 1148 1150

1152 1154 1146 1148 1150 1152 1154

CITY OF RIVERSIDE
 CROSS SECTIONS
 ARLINGTON AVENUE BETWEEN
 VICTORIA AVE. & ALESSANDRO BLVD.

SCALE
 DATE 7-63
 DRAWN
 TRACED
 CHECKED
 F.B.

Scale Vert 1"=2'
Hor. 1"=10'

ALBERT A. WEBB ASSOCIATES
 CIVIL ENGINEERS
 RIVERSIDE CALIFORNIA

1154

W.O. 60-115
 SHEET 48
 OF SHEETS
 DWG. NO.

1164

1164

1150
1148
1144
1054
1052
1048
1046
1154
1152
1150
1158
1156
1154
1152
1050
1052
1054
1150
1152
1154
1156
1158
1150
1152
1154
1156
1158
1050
1052
1054
1148
1150
1152

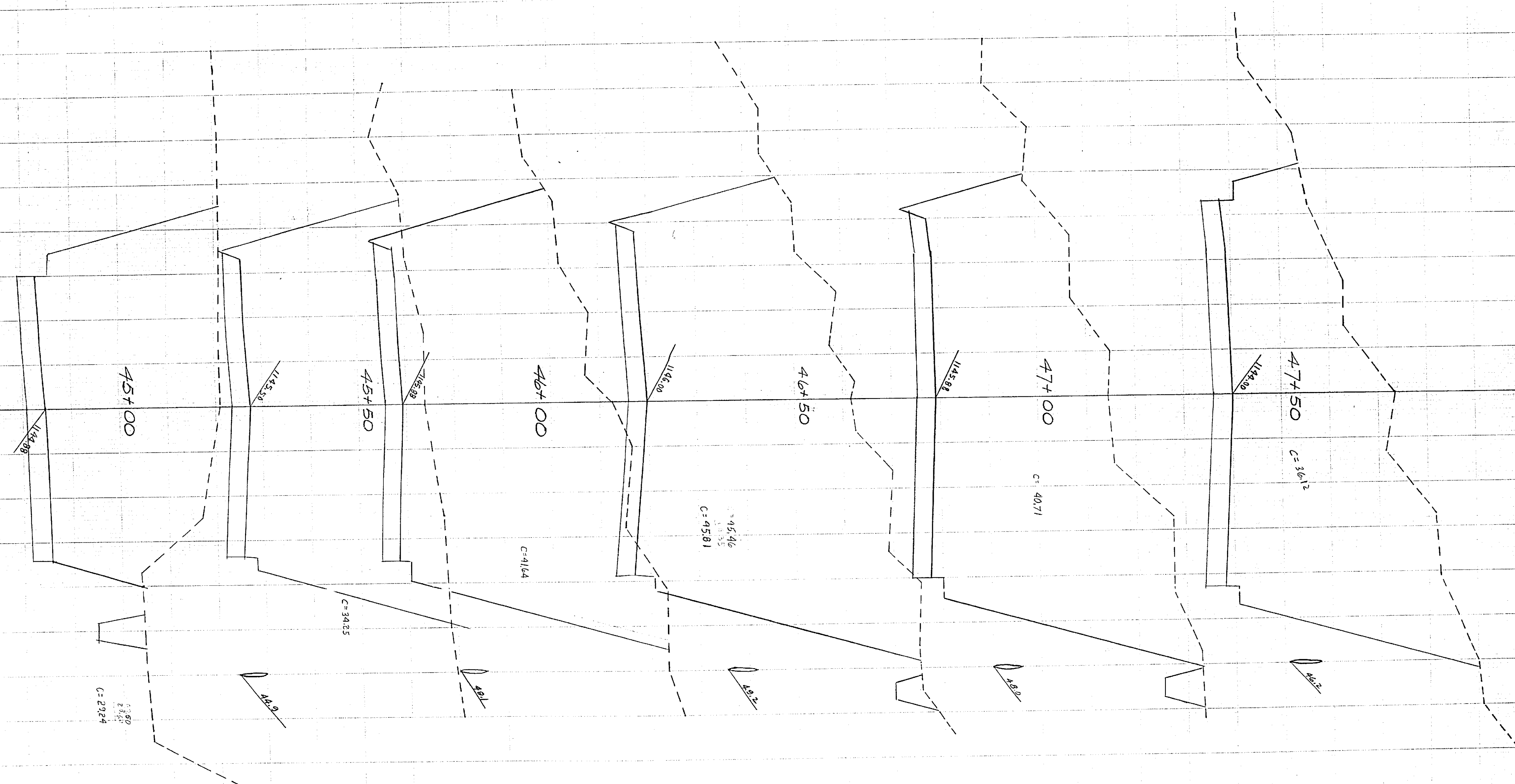

1052
1054
1056
1150
1152
1154
1156
1158
1050
1052
1054
1148
1150
1152

1164

Scale Vert. 1"=2'
Hor. 1"=10'

CITY OF RIVERSIDE
CROSS SECTIONS
ARLINGTON AVENUE BETWEEN
VICTORIA AVE. & ALESSANDRO BLVD.

SCALE	DATE 7-63	ALBERT A. WEBB ASSOCIATES	W.O. 60-115
DRAWN		CIVIL ENGINEERS	SHEET 49
TRACED		RIVERSIDE CALIFORNIA	OF SHEETS
CHECKED			DWG. NO.
T.B.			

1164

1164

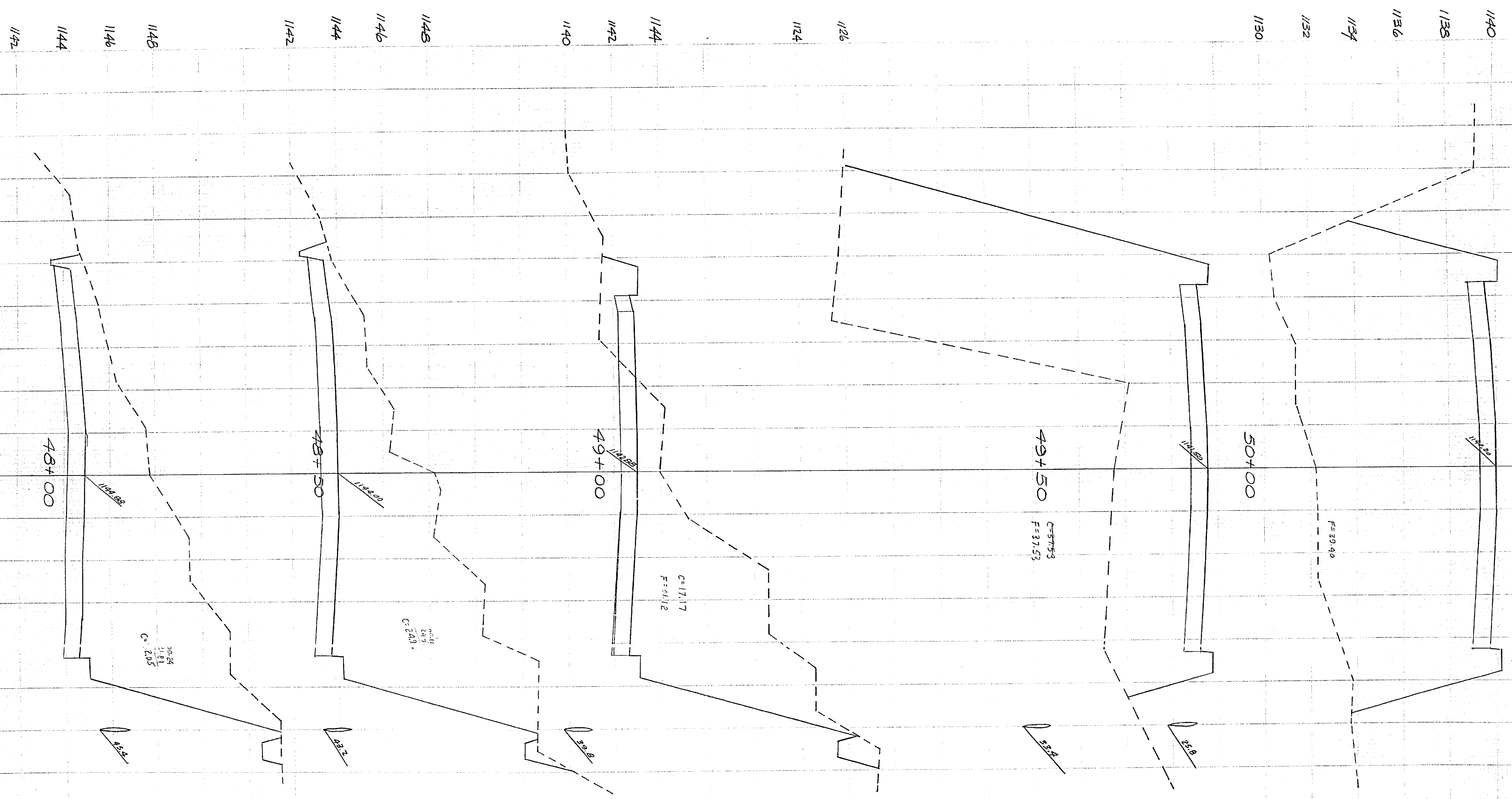

Scale Vert. 1"=2'
Hor. 1"=10'

SCALE	DATE 7-23	ALBERT A. WEBB ASSOCIATES CIVIL ENGINEERS RIVERSIDE, CALIFORNIA <i>1164</i>	W.O. 60-115
DRAWN			SHEET 50
TRACED			OF SHEETS
CHECKED			DWG. NO.
P.E.			

CITY OF RIVERSIDE
 CROSS SECTIONS
 ARLINGTON AVENUE BETWEEN
 VICTORIA AVE. & ALESSANDRO BLVD.

1164

1164

1136
1134
1132
1130
1128
1126
1124
1122
1120
1118
1116

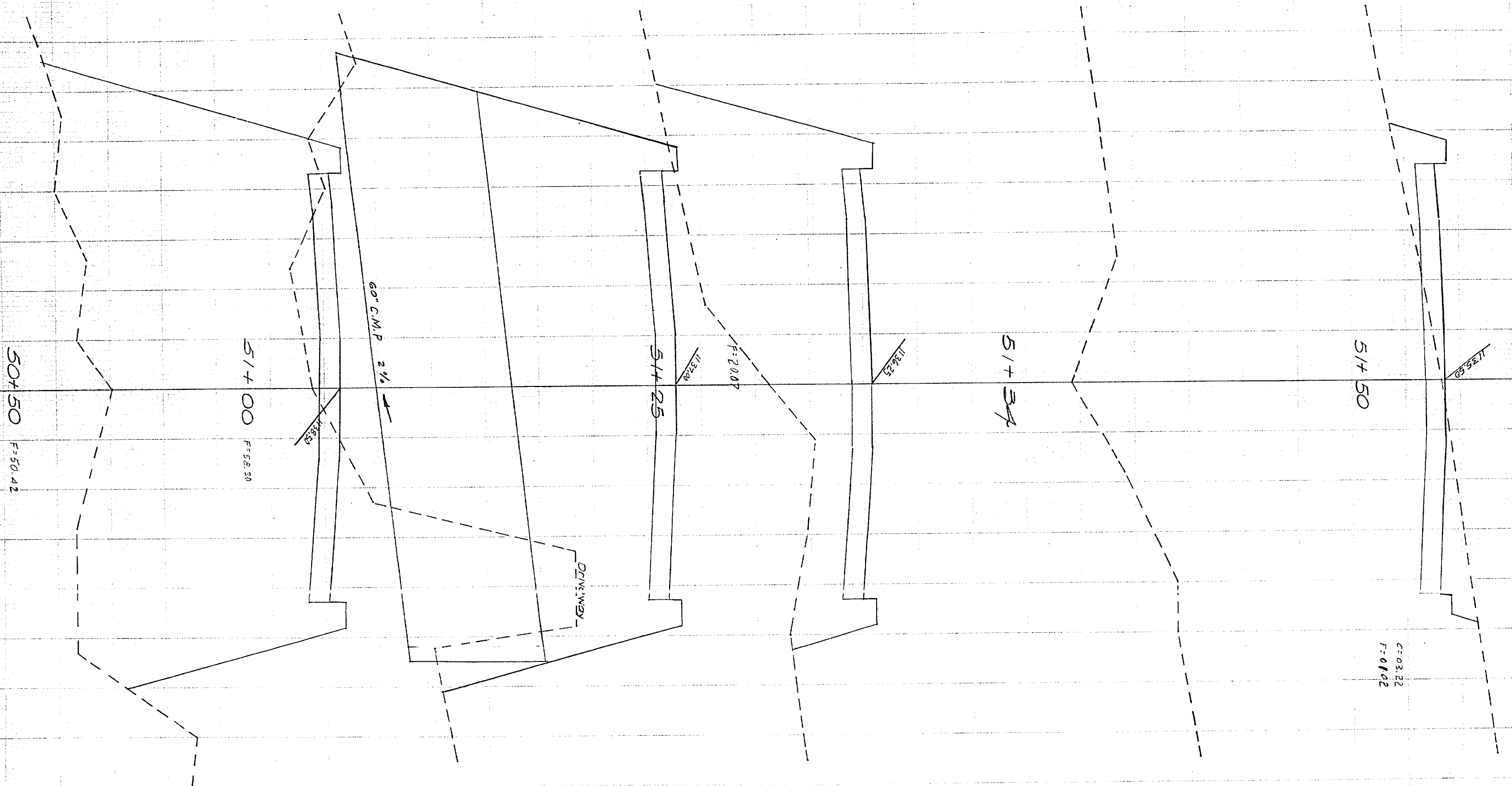

1136
1134
1132
1130
1128
1126
1124
1122
1120
1118
1116

1138
1136
1134
1132
1130
1128
1126
1124
1122
1120
1118
1116

Scale Vert. 1"=2'
Hor. 1"=10'

CITY OF RIVERSIDE

CROSS SECTION

ARLINGTON AVENUE BETWEEN

VICTORIA AVE. & ALESSANDRO BLVD.

SCALE

DATE 7-63

DRAWN

TRACED

CHECKED

P.B.

ALBERT W. WEBB ASSOCIATES

CIVIL ENGINEERS

RIVERSIDE CALIFORNIA

W.D. 20115

SHEET 51

OF 56

DWG. NO.

PLANS AND PROFILES
NO. 1164
 FOR THE CONSTRUCTION OF STORM DRAINS
 IN ARLINGTON AVENUE
 FROM PALM AVENUE TO HORACE STREET
 IN MARY STREET
 FROM ARLINGTON AVENUE TO CANAL DRIVE
 IN HORACE STREET AND DURANGO ROAD
 FROM ARLINGTON AVENUE TO LARAMIE ROAD

CITY OF RIVERSIDE - CALIFORNIA

REFER P.B. 437/75
 486/56
 501/58
 510/25
 541/19

SCALE PLAN 1"=50' UNLESS NOTED
 PROFILE HORIZ 1"=50'
 VERT 1"=5'

APPROVED

M.H. IRVING
 REG. C.E. 3011
 CITY ENGINEER

THESE PLANS APPROVED AND ADOPTED
 BY THE MAYOR AND COUNCIL OF THE
 CITY OF RIVERSIDE, CALIFORNIA
 THIS DAY OF

N27
 BUILT

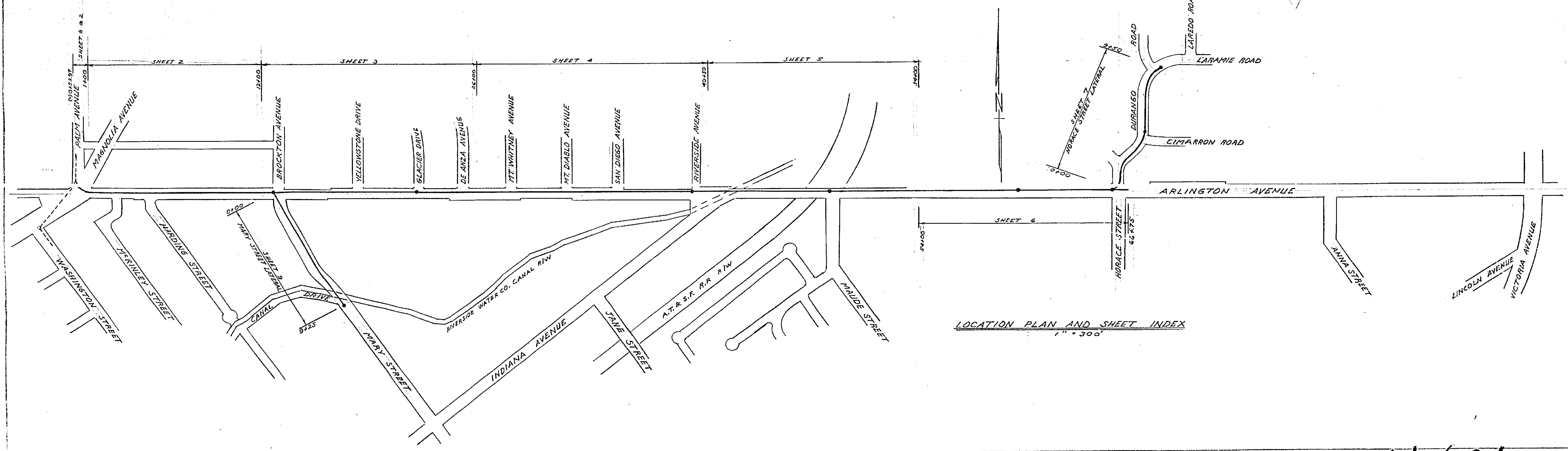

LOCATION PLAN AND SHEET INDEX
 1" = 300'

1164

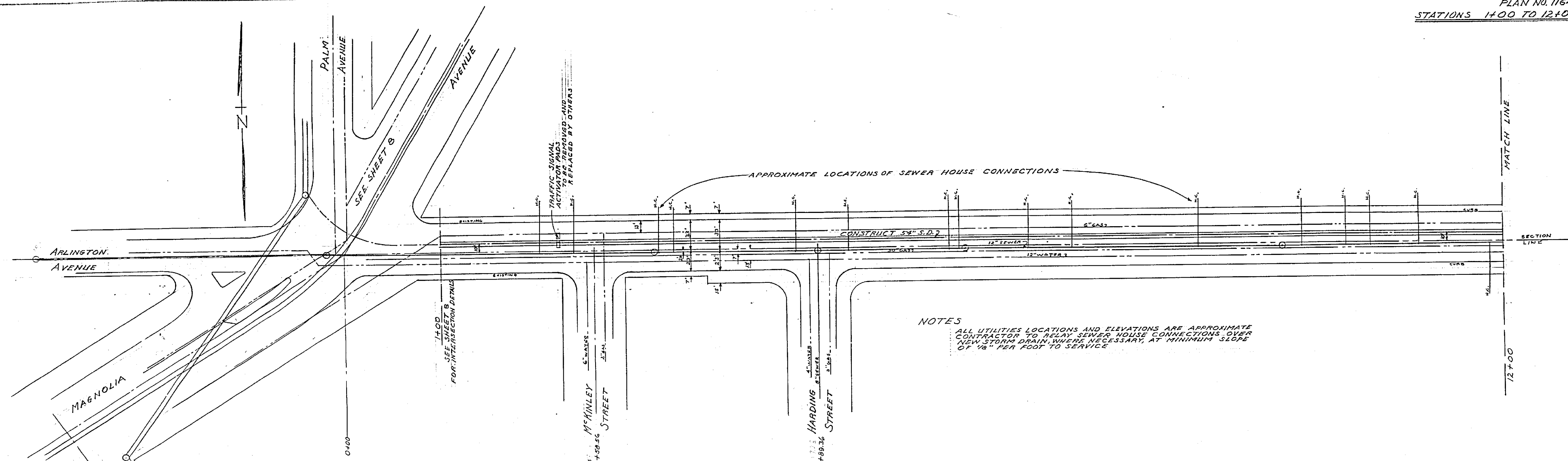

NOTES
 ALL UTILITIES LOCATIONS AND ELEVATIONS ARE APPROXIMATE
 CONTRACTOR TO RELAY SEWER HOUSE CONNECTIONS OVER
 NEW STORM DRAIN WHERE NECESSARY, AT MINIMUM SLOPE
 OF 1% PER FOOT TO SERVICE.

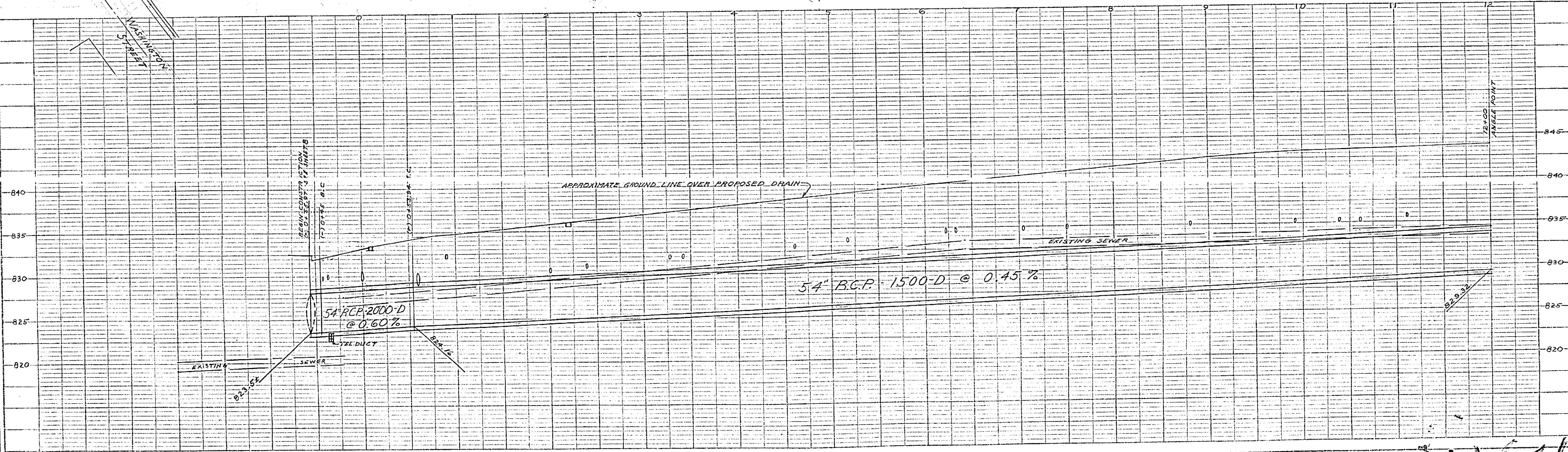

DATE	BY

DATE	BY

1164

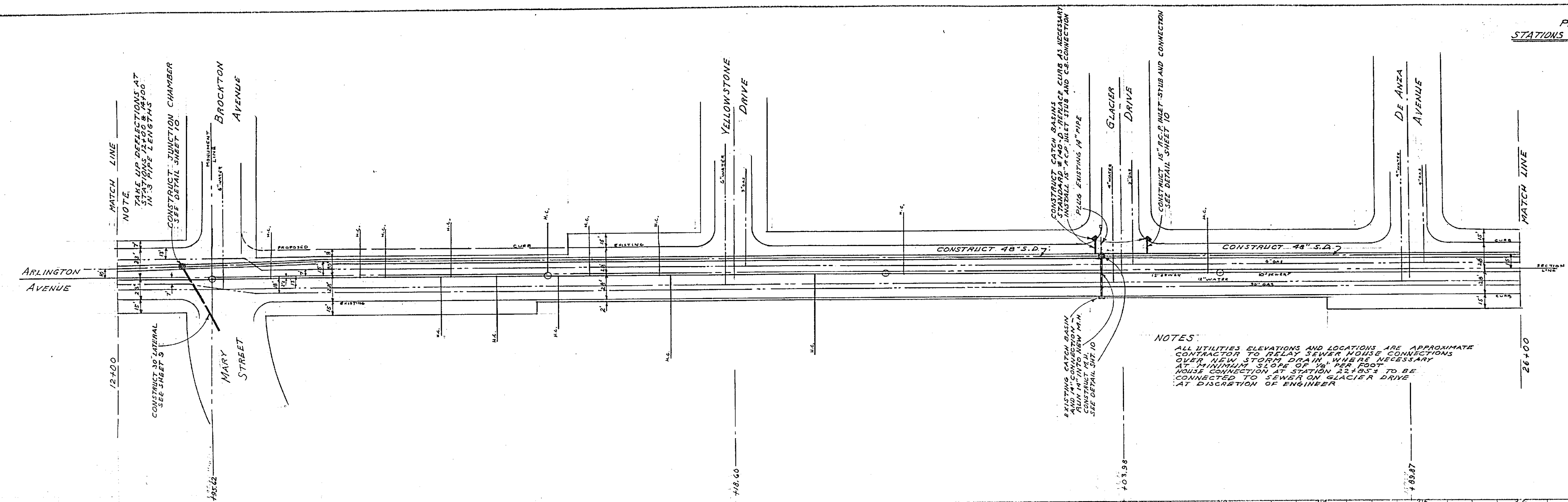

NOTES:
 ALL UTILITIES ELEVATIONS AND LOCATIONS ARE APPROXIMATE
 CONTRACTOR TO RELAY SEWER HOUSE CONNECTIONS
 OVER NEW STORM DRAIN WHERE NECESSARY
 AT MINIMUM SLOPE OF 1/8\"/>

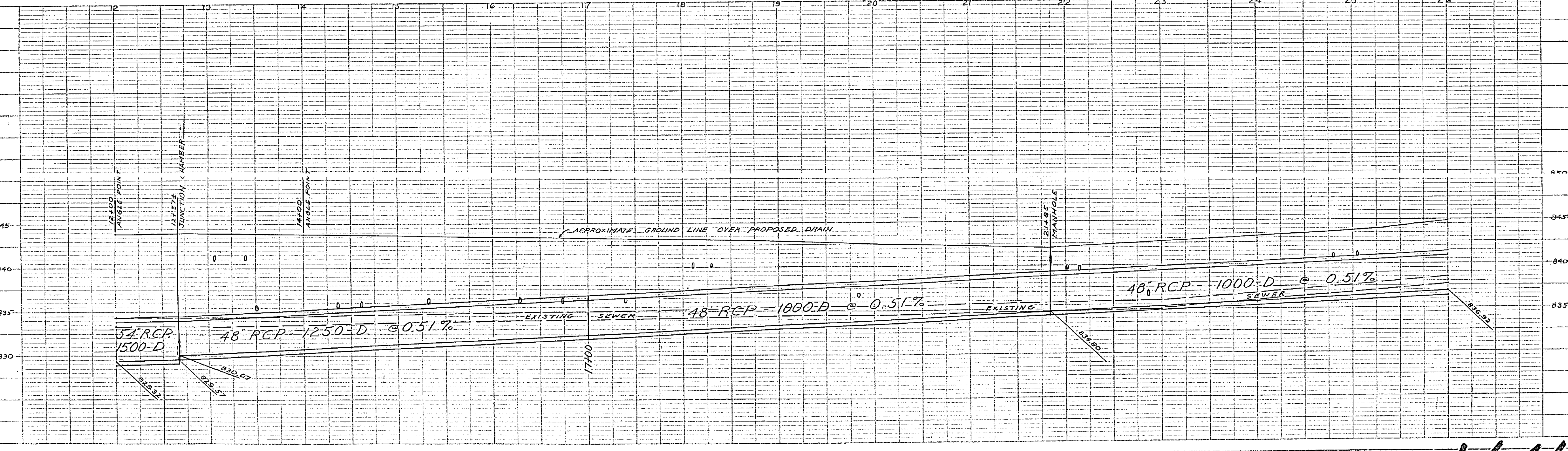

BY	DATE	DESCRIPTION

BY	DATE	DESCRIPTION

1164

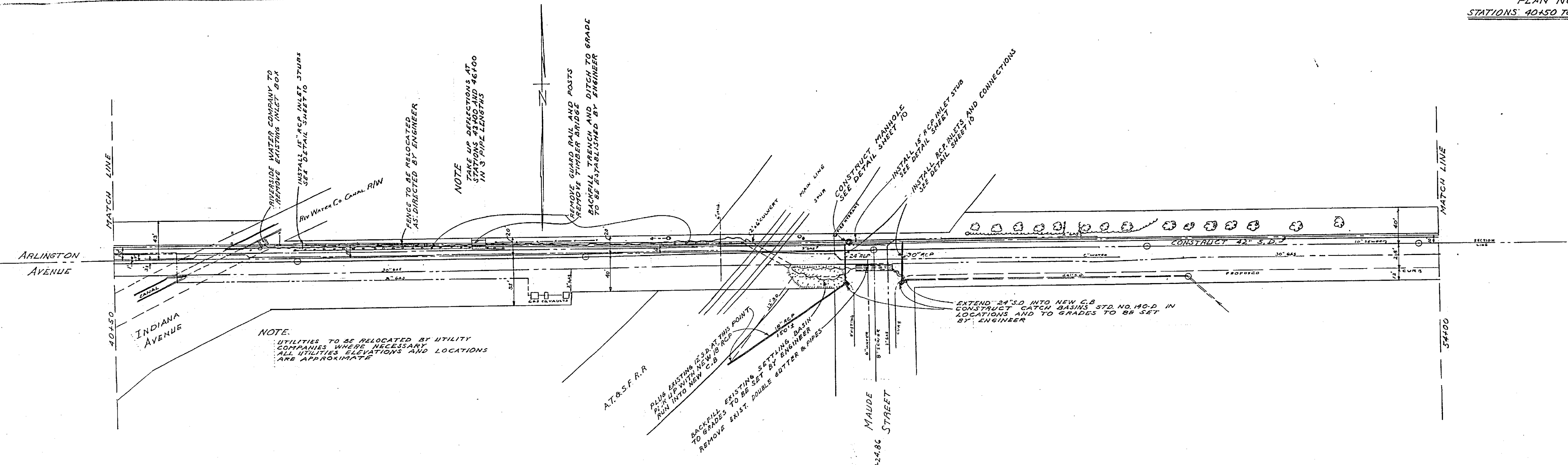

NO.	DATE	BY	CHKD.

NO.	DATE	BY	CHKD.

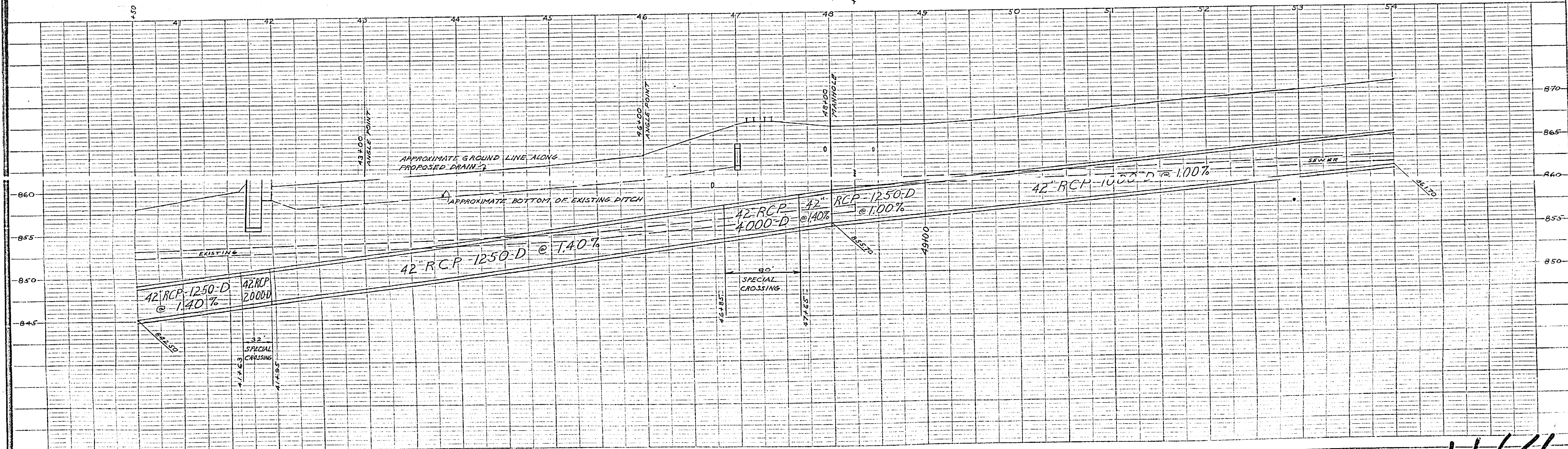

1164

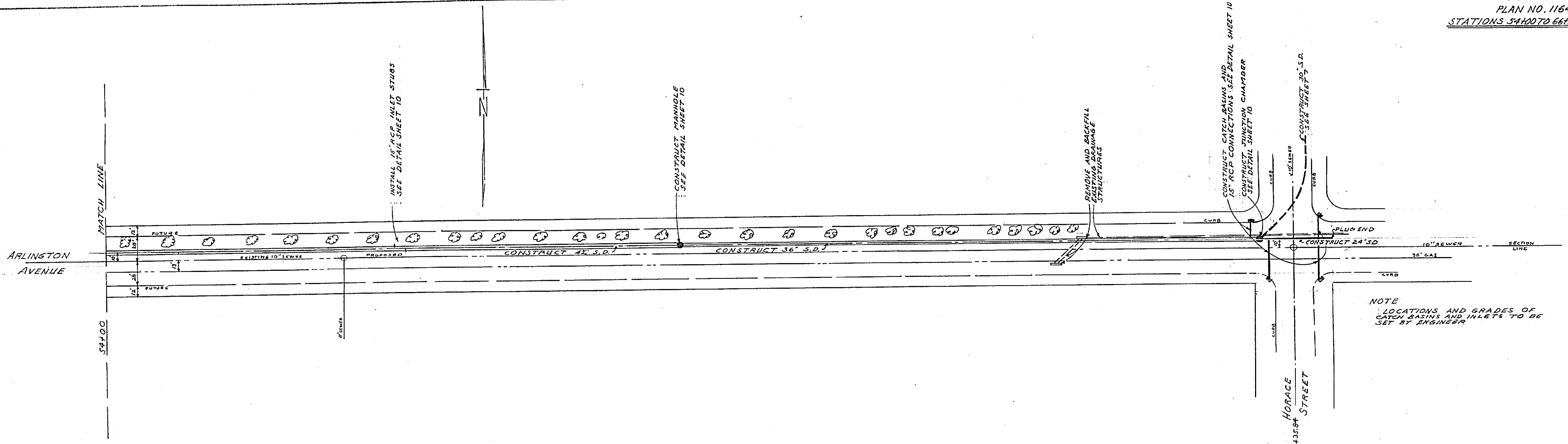

NOTE
 LOCATIONS AND GRADES OF
 CATCH BASINS AND INLETS TO BE
 SET BY ENGINEER

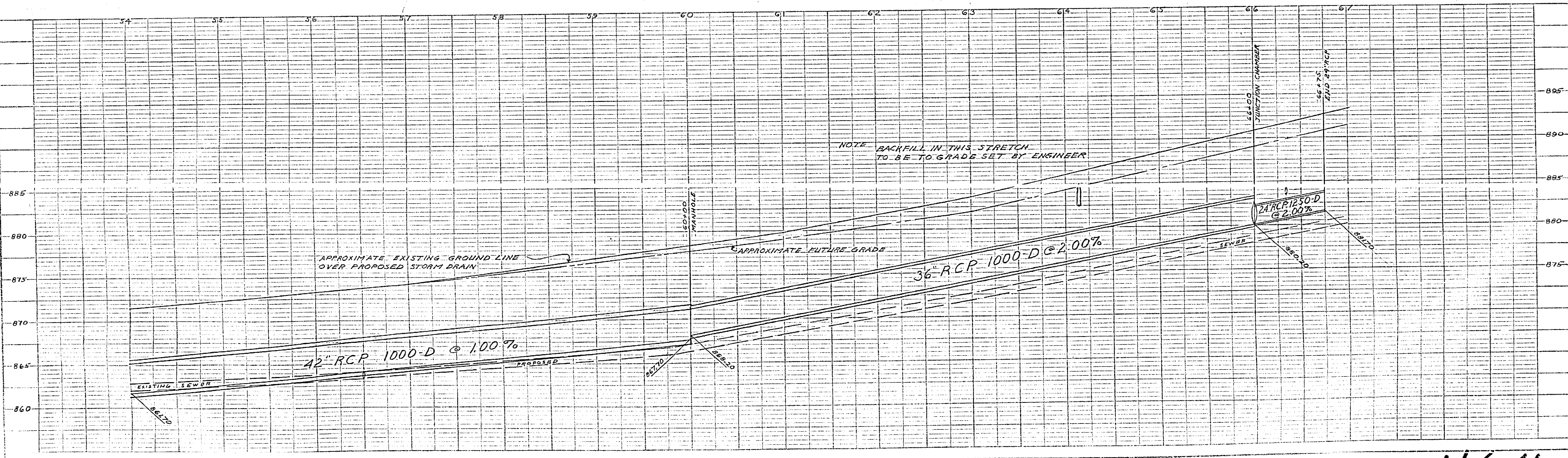

NOTE
 BACKFILL IN THIS STRETCH
 TO BE TO GRADE SET BY ENGINEER

1164

DATE	
BY	
CHECKED	
DESIGNED	
PROJECT	
SCALE	
DATE	

PROJECT	
SCALE	
DATE	
DESIGNED	
CHECKED	
BY	
DATE	

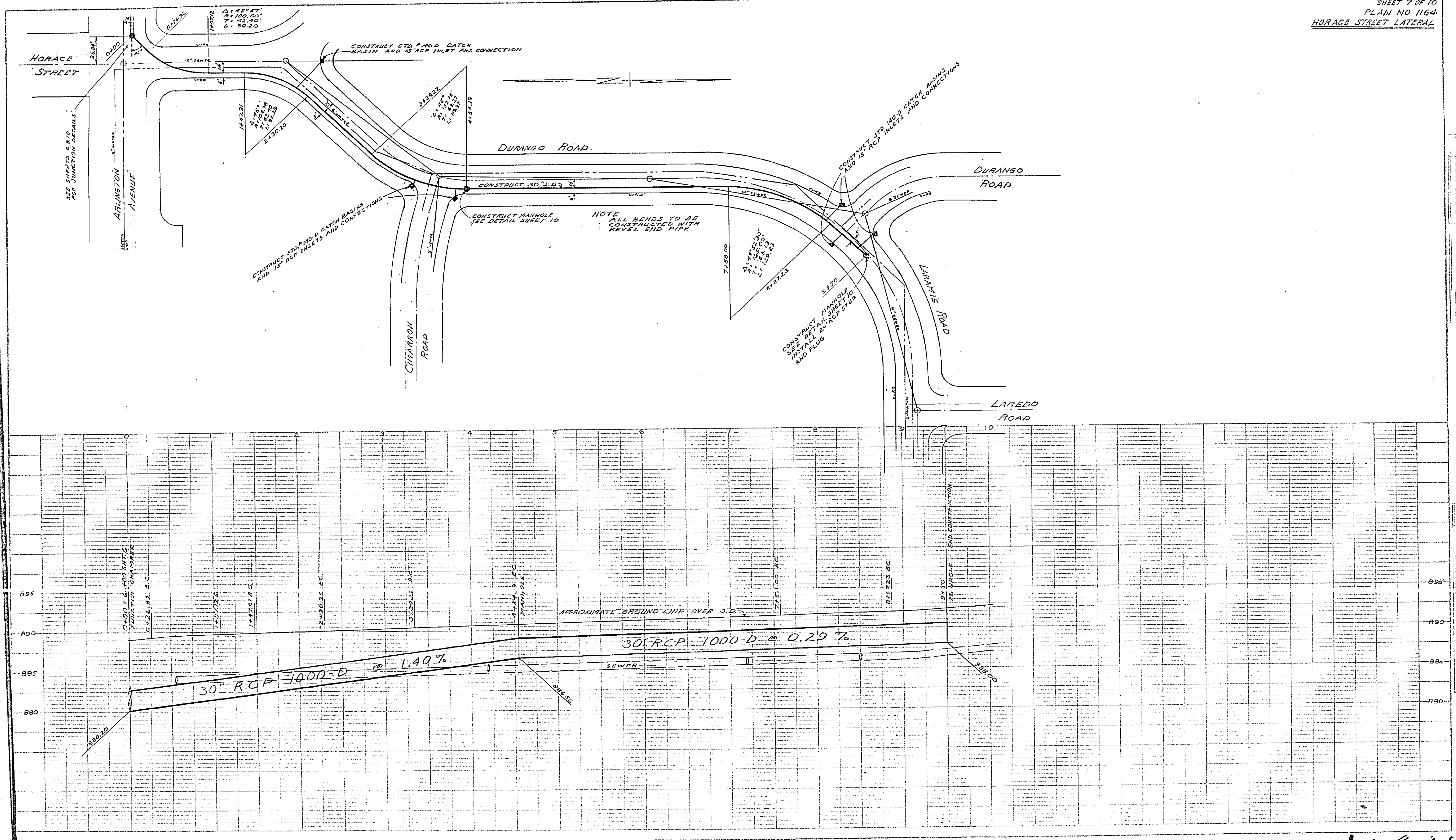

DATE	
SCALE	
BY	
CHECKED	
APPROVED	
PROJECT NO.	
SHEET NO.	

DATE	
SCALE	
BY	
CHECKED	
APPROVED	
PROJECT NO.	
SHEET NO.	

1164

SHEET 9 OF 10
PLAN NO. 1164
MARY STREET LATERAL

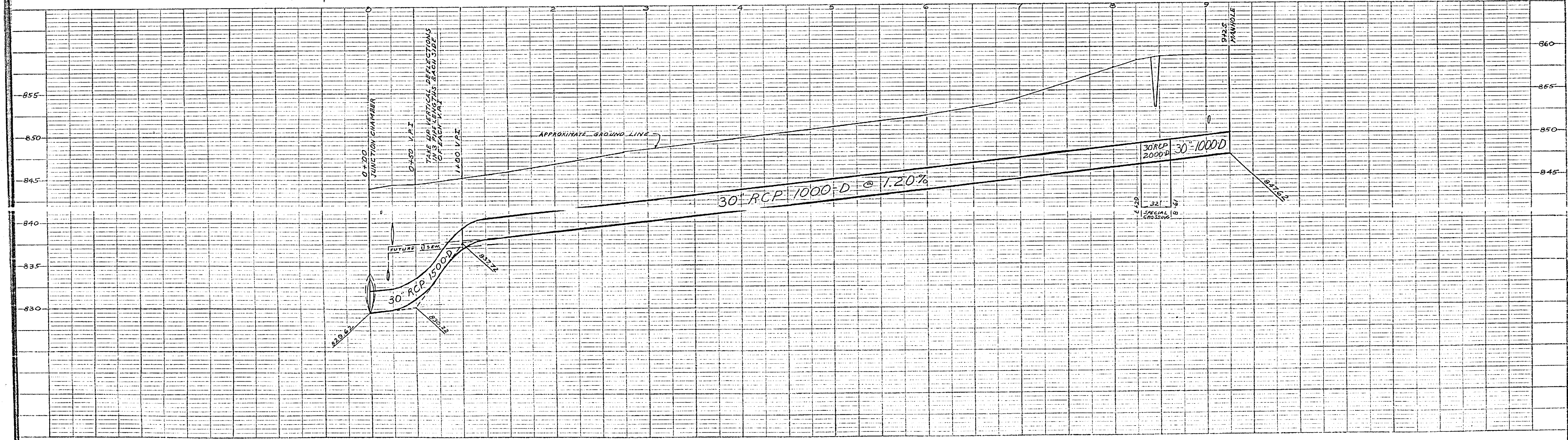
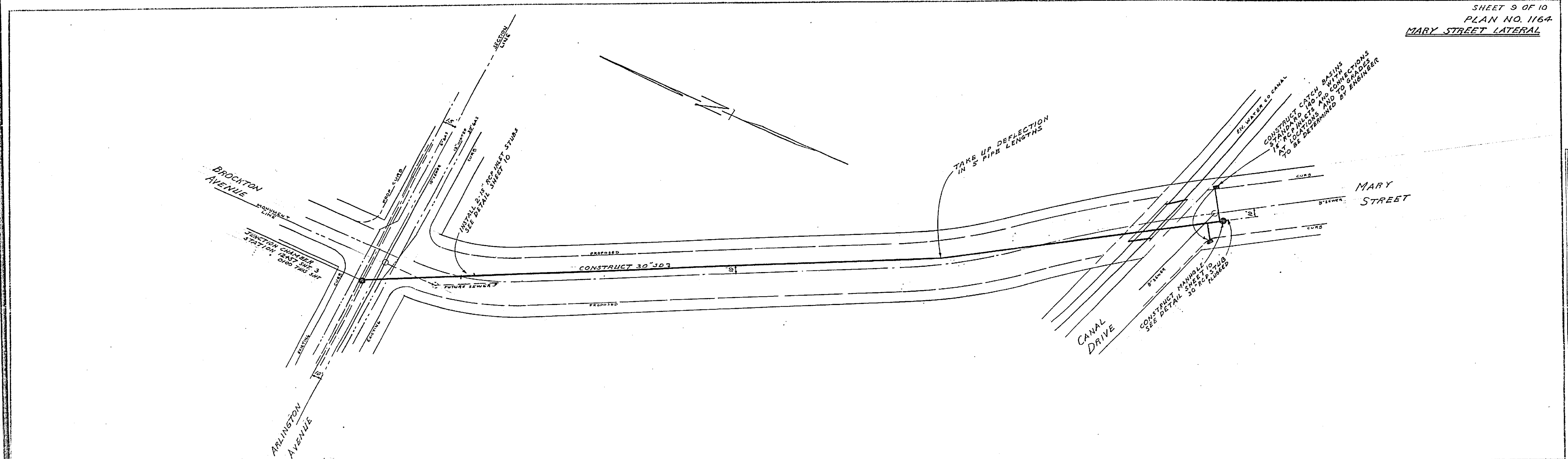

BY OR FOR THE ENGINEER	DATE
BY OR FOR THE CITY	DATE
BY OR FOR THE BOARD	DATE
BY OR FOR THE STATE	DATE

PROJECT NO.	DATE
BY	DATE
CHECKED BY	DATE
APPROVED BY	DATE

1164

SCALE: 1" = 20' HORIZONTAL, 1" = 4' VERTICAL

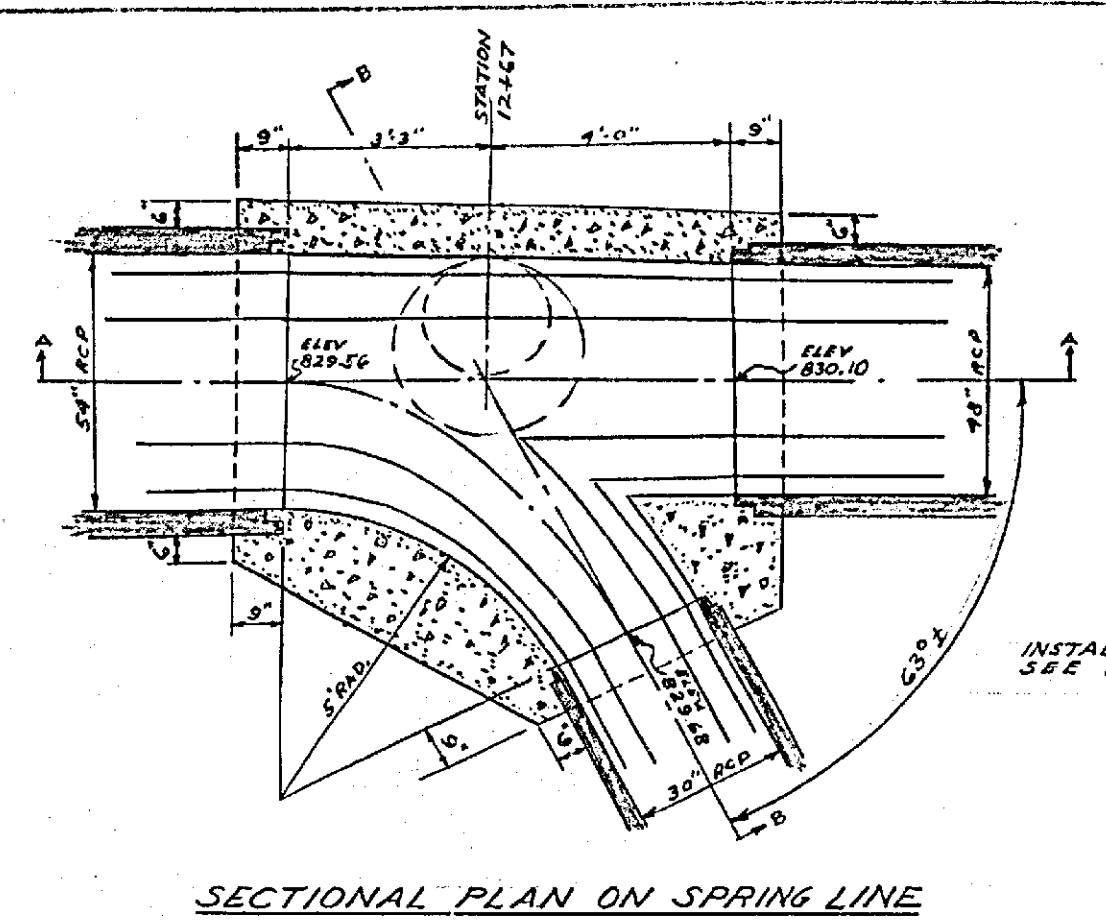

SECTIONAL PLAN ON SPRING LINE

NOTE
 ALL REINFORCING STEEL $\frac{1}{2}"$ #4
 KEEP $1\frac{1}{2}"$ CLEAR TO FACE OF CONCRETE
 TOP SLAB - 12" O.C. BOTH WAYS - BOTH FACES
 SIDES - OUTSIDE FACE - 12" O.C. - BRICKS
 INSIDE FACE BITTO TO 1" BELOW SPRING LINE
 BOTTOM - 12" O.C. - 12" O.C. - TOP FACE ONLY
 TOP CORNERS - 18" x 18" - 12" O.C.
 OPENINGS - #4 DIAGONALS - 4" O.C. - D.F.

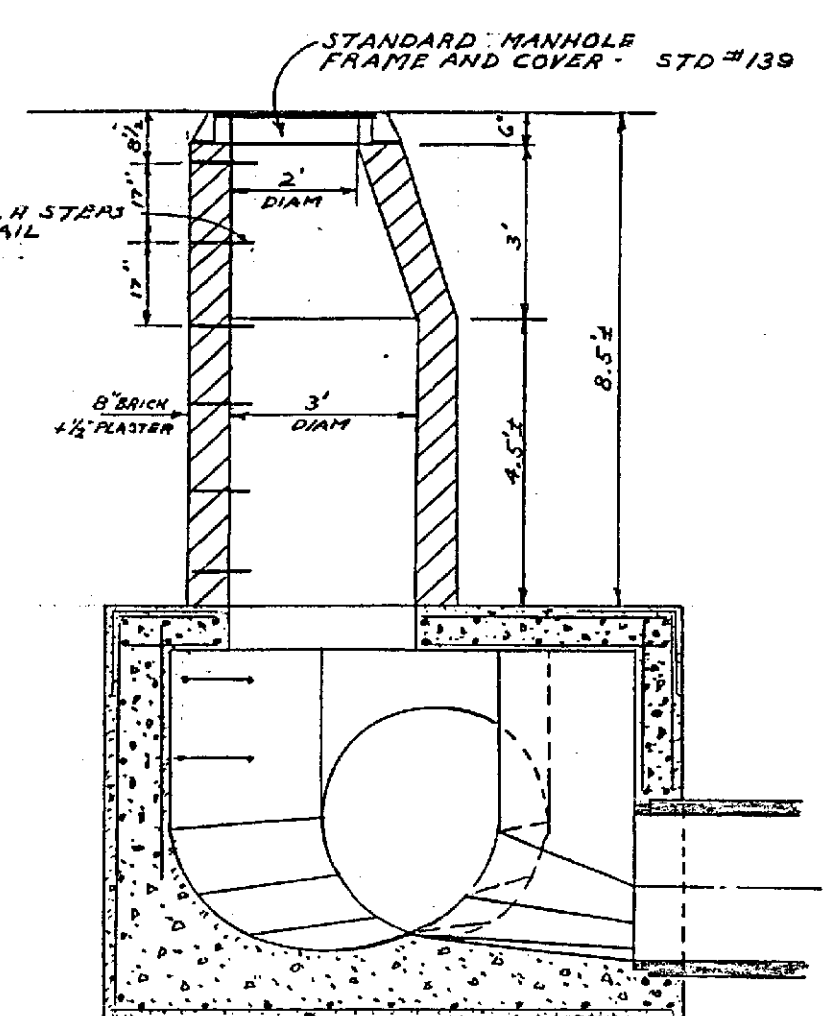

SECTION B-B SHOWING MANHOLE AND REINFORCING STEEL

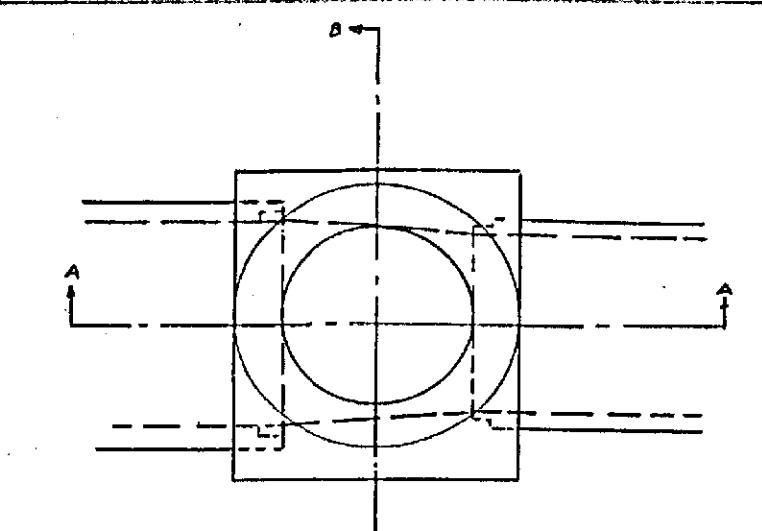

PLAN AT TOP OF CONCRETE

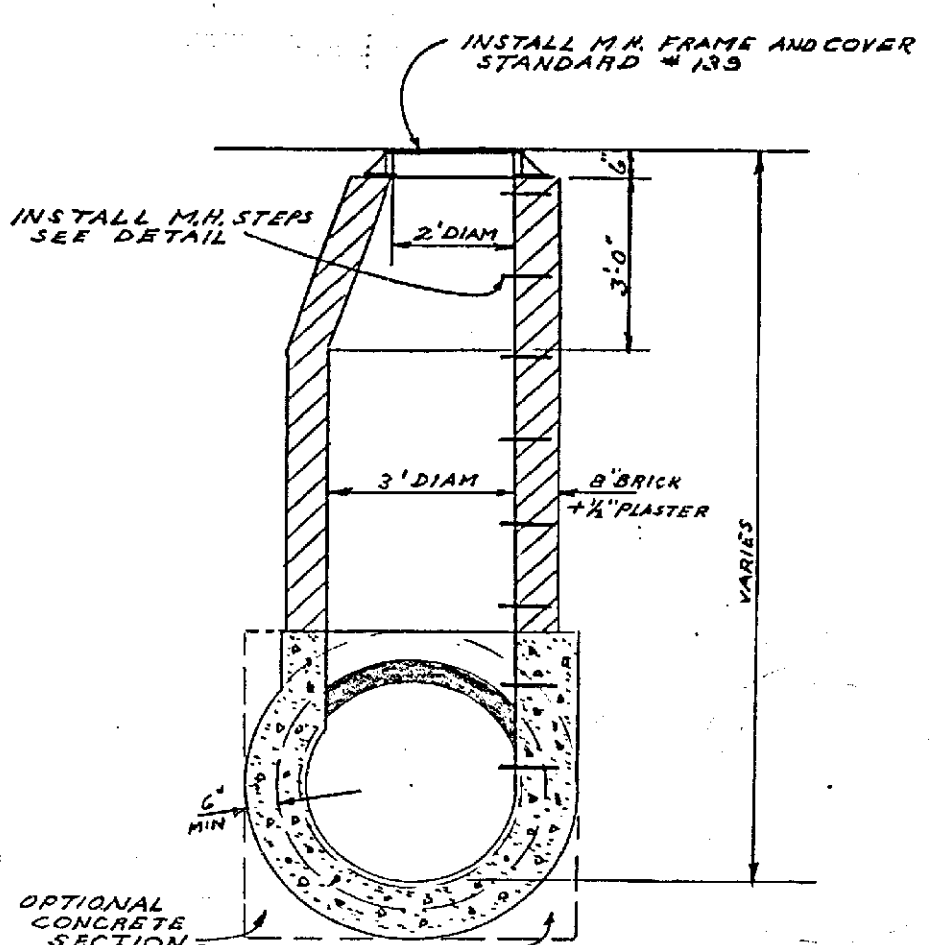

SECTION B-B OPTIONAL CONCRETE SECTION

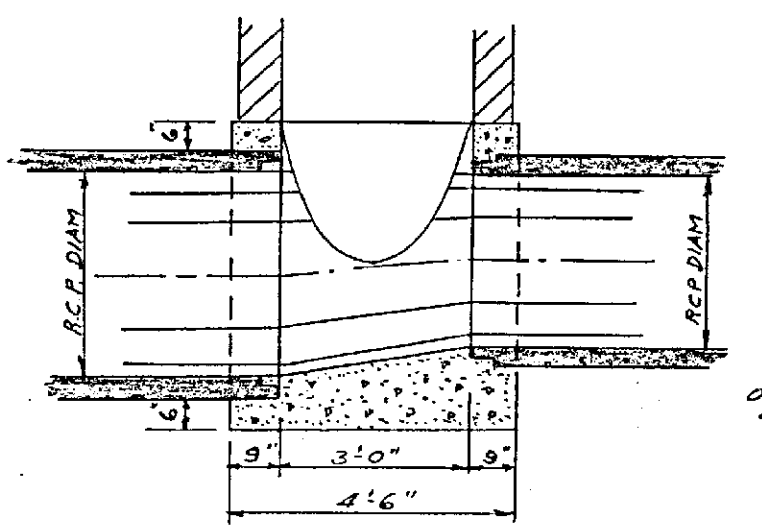

SECTION A-A

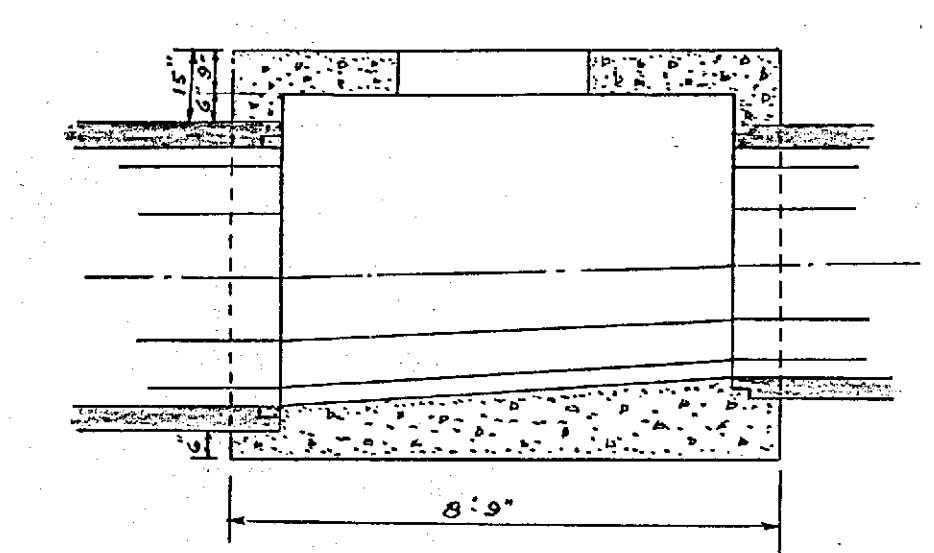

SECTION A-A

JUNCTION CHAMBER AT STATION 12+57 1/8" x 1'-0"

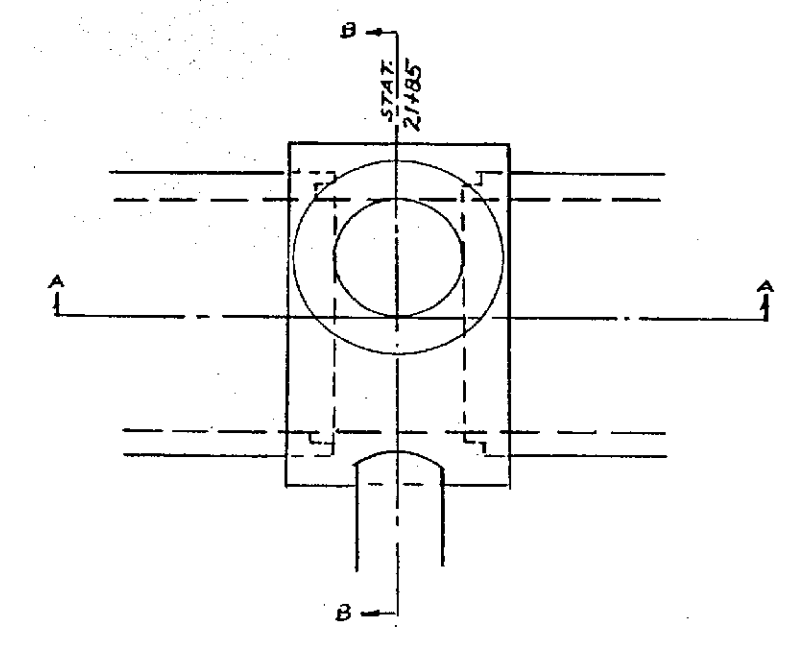

PLAN AT TOP OF CONCRETE

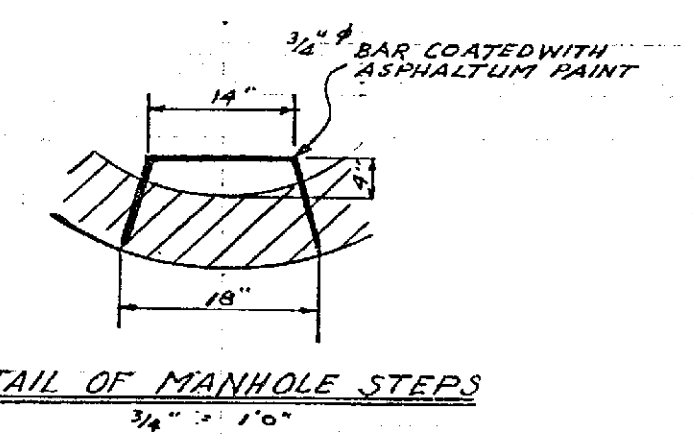

DETAIL OF MANHOLE STEPS 3/4" x 1'-0"

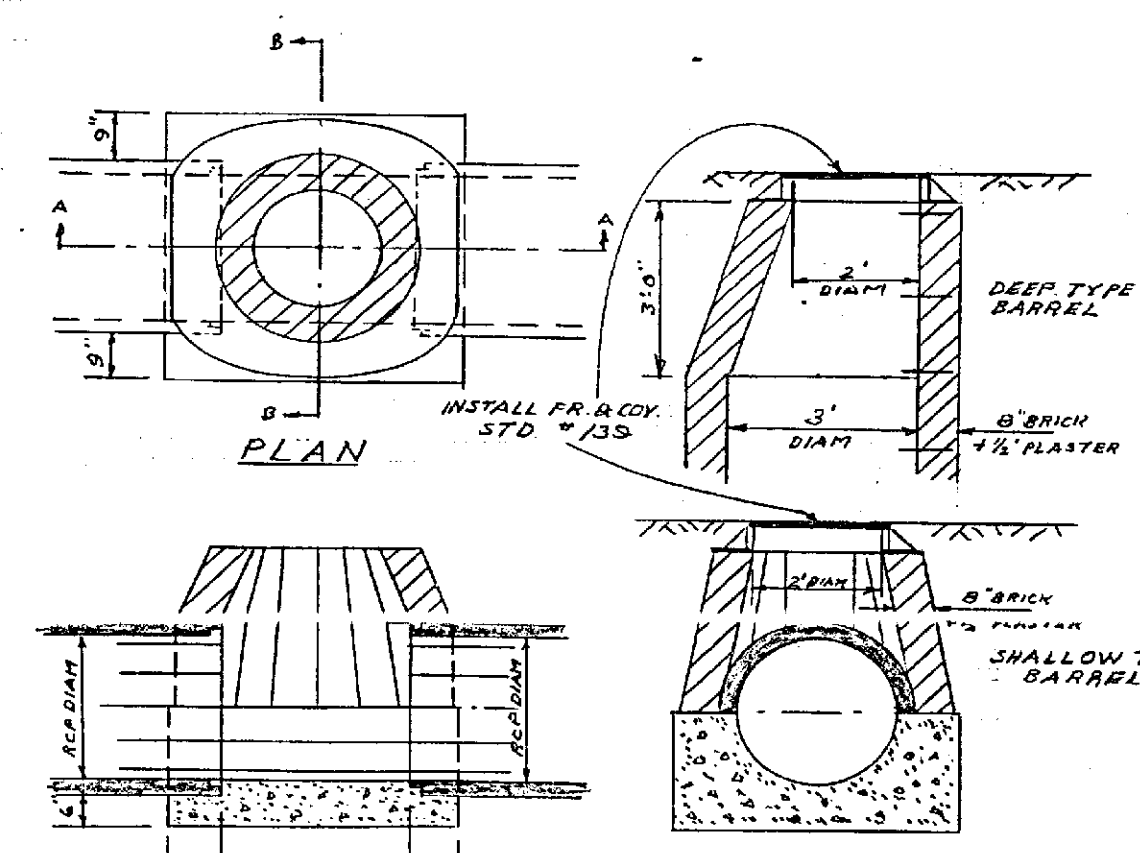

SECTION A-A SECTION B-B

STANDARD SMALL PIPE MANHOLE AT STATIONS 4+54.19 & 9+25 (MORACE STREET LATERAL) AND STATION 9+25 (MARY STREET LATERAL) 3/8" x 1'-0"

NOTE
 MANHOLE STEPS TO BE INSTALLED IN MARY STREET MANHOLE

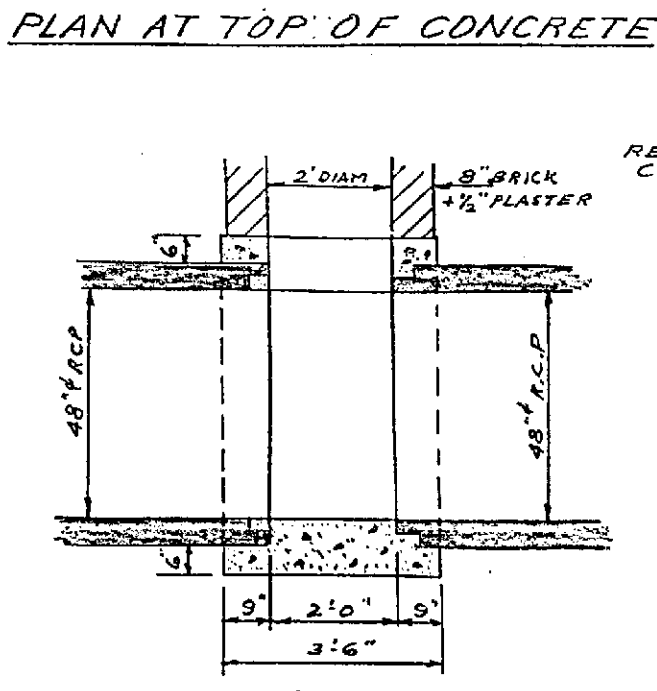

SECTION A-A

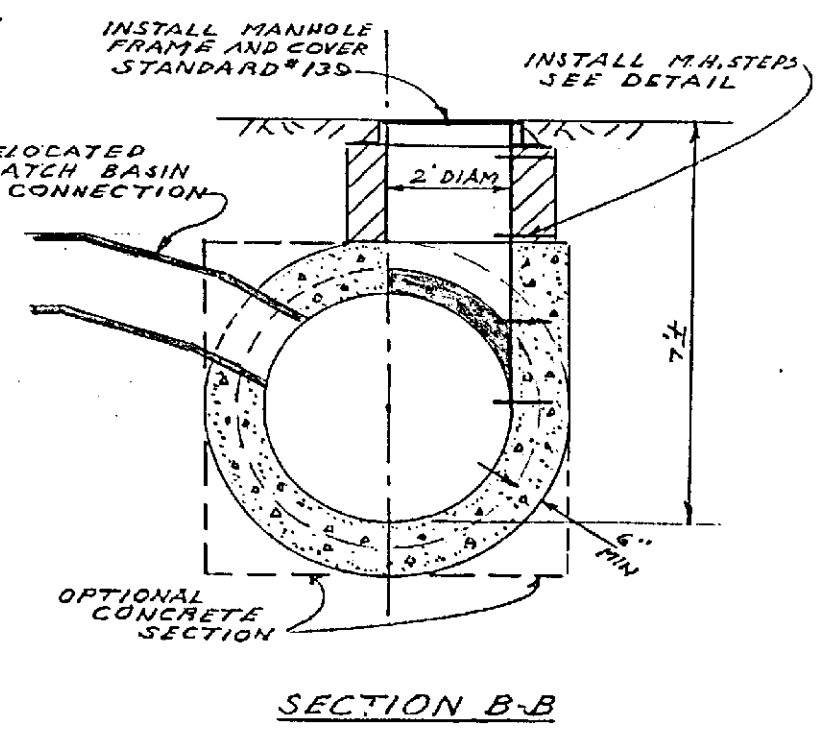

SECTION B-B

MANHOLE AT STATION 21+85 3/8" x 1'-0"

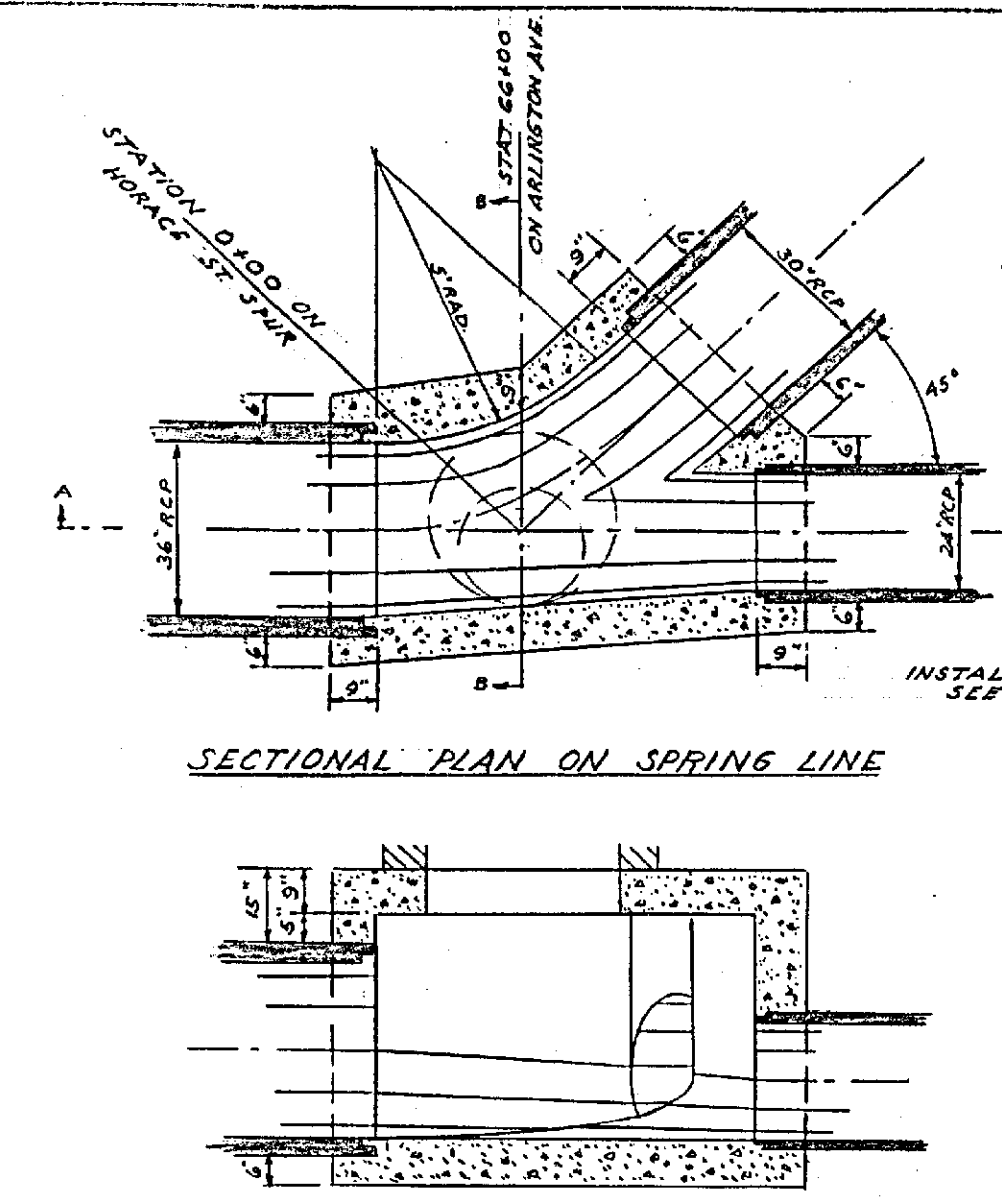

SECTIONAL PLAN ON SPRING LINE

NOTE
 SEE DETAIL OF CHAMBER AT STATION 12+57 FOR REINFORCING STEEL REQUIREMENTS

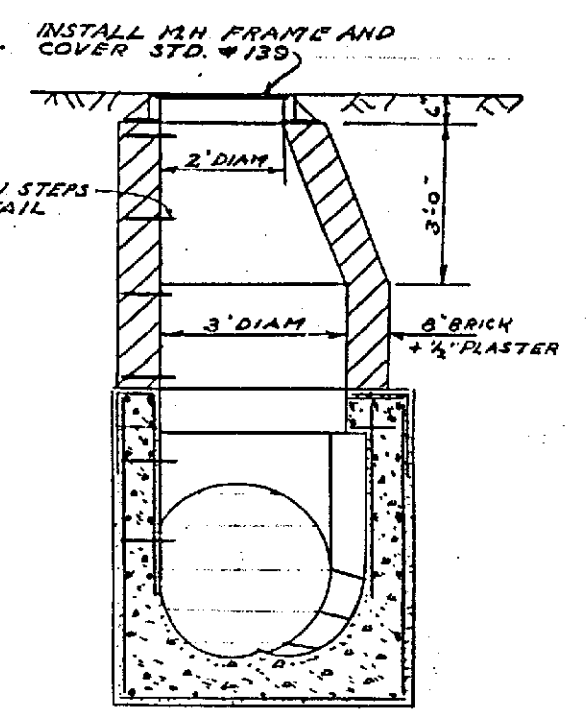

SECTION B-B SHOWING M.H. AND STEEL

SECTION A-A

JUNCTION CHAMBER AT STATION 66+00 3/8" x 1'-0"

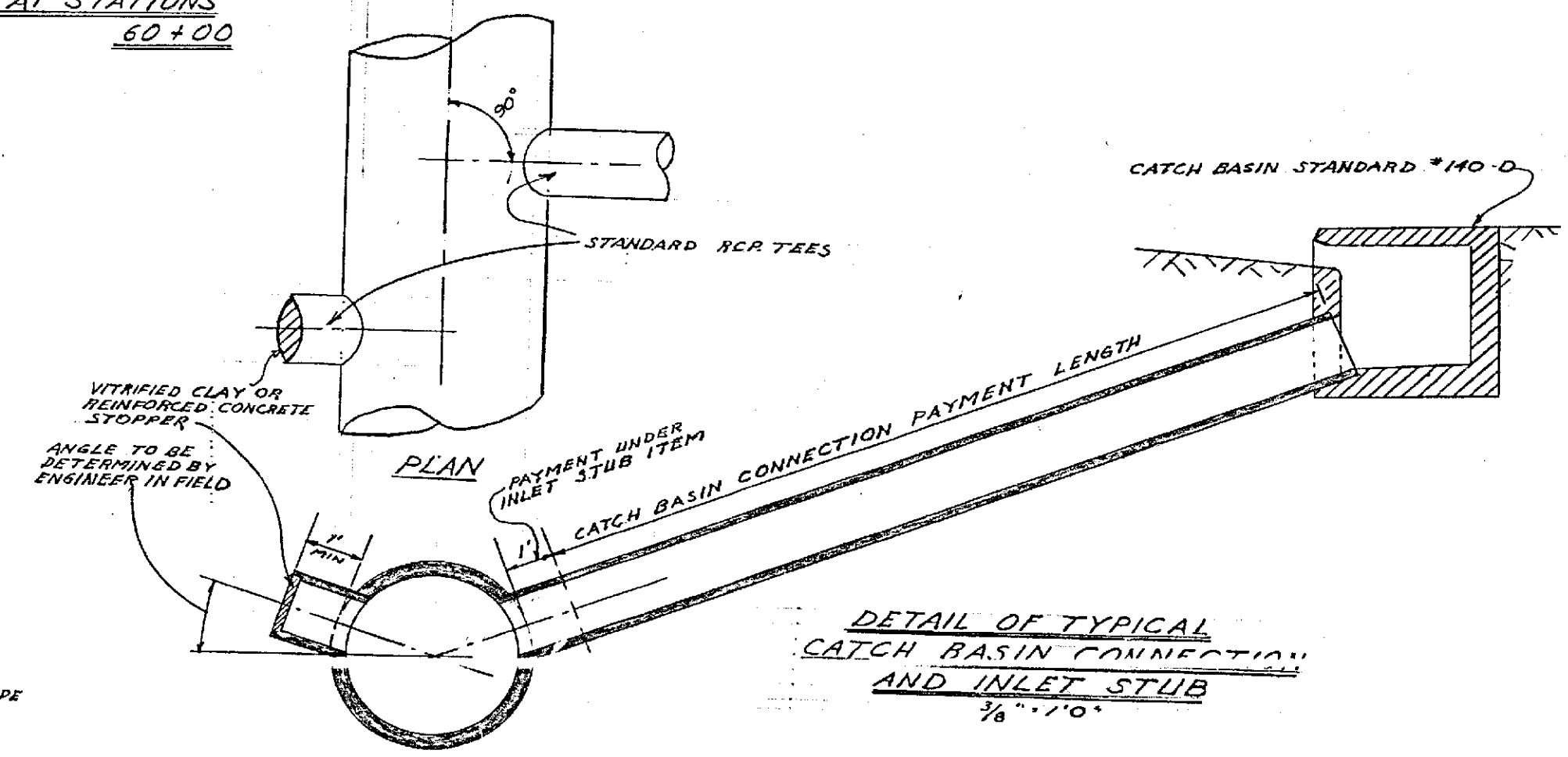

DETAIL OF TYPICAL CATCH BASIN CONNECTION AND INLET STUB 3/8" x 1'-0"

15911

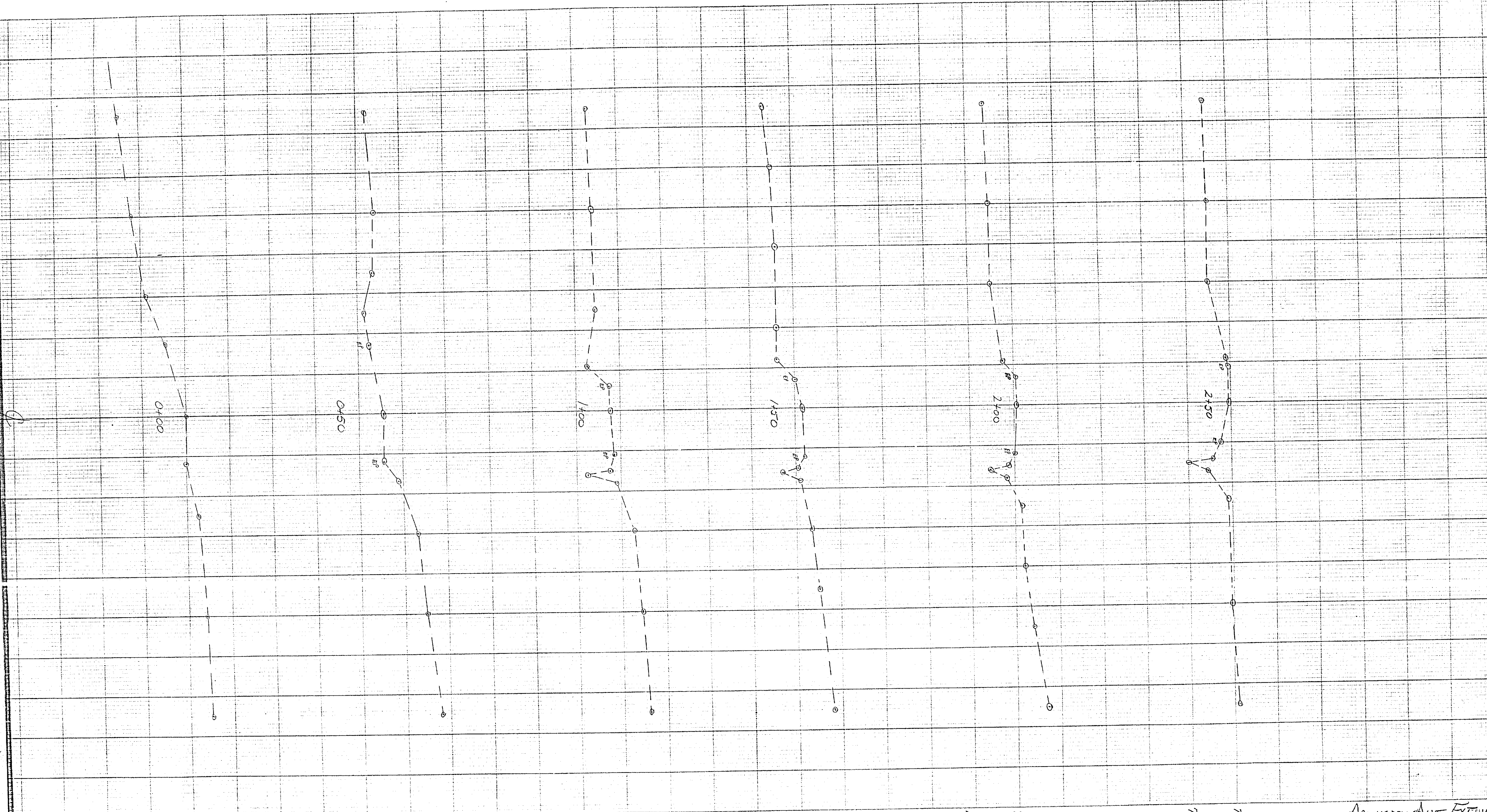

64

66

68

CLEARPRINT CO. SECTION 12 X 10
"CLEARPRINT PAPER CO."

68

70

72

68

70

72

70

72

74

CLEARPRINT CO. SECTION 12 X 10
"CLEARPRINT PAPER CO."

72

74

74

76

7164

ARLINGTON AVE EXT. CLEARPRINT CO.
DATE: SEPT. 28, 1964
RSK

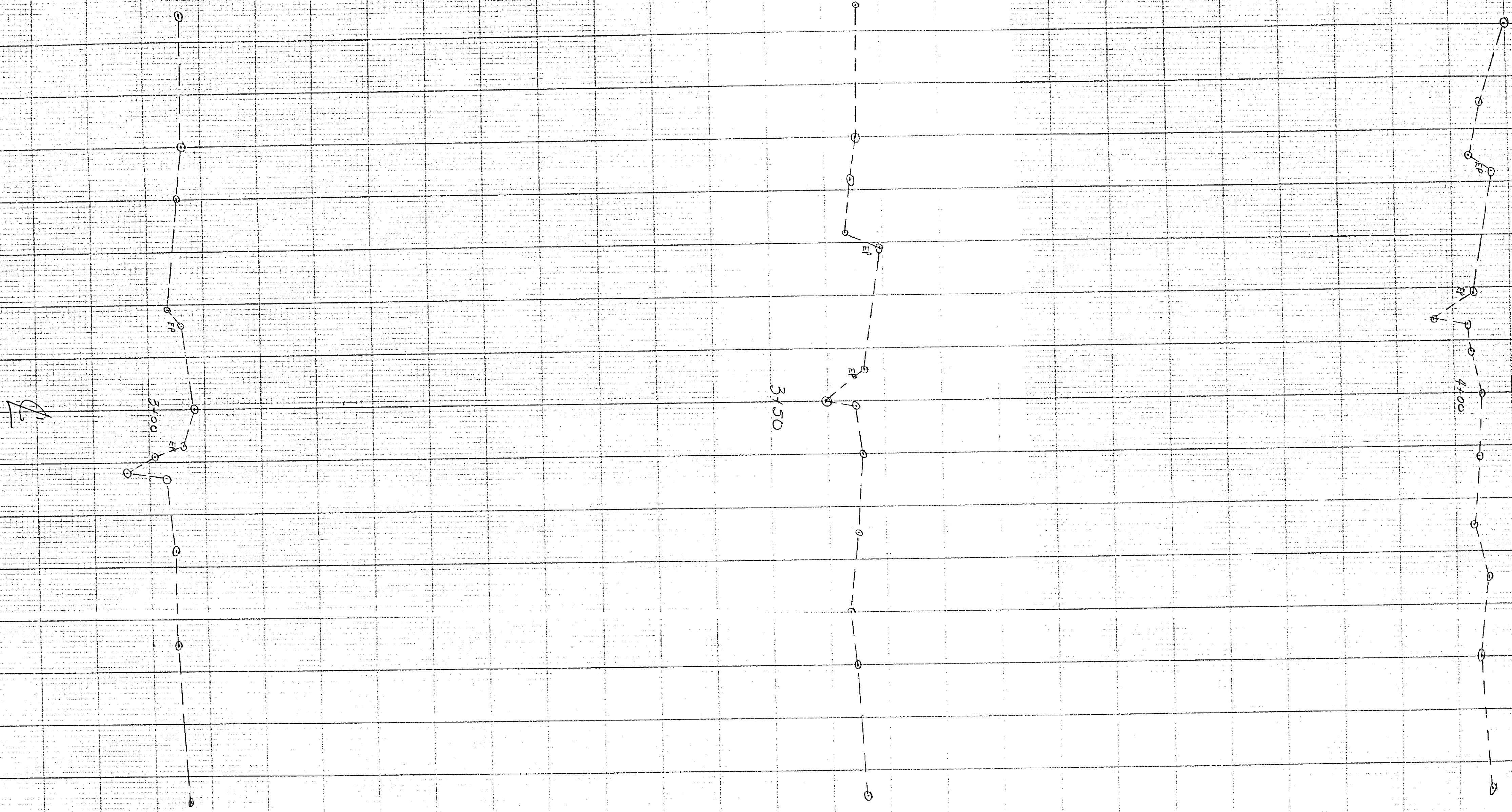

74
76
78

CLEARPRINT PAPER CO.

78
80

88

CLEARPRINT PAPER CO.

1164

ARLINGTON AVE EXT
Date: Sept 28, 1964
RGL

1164

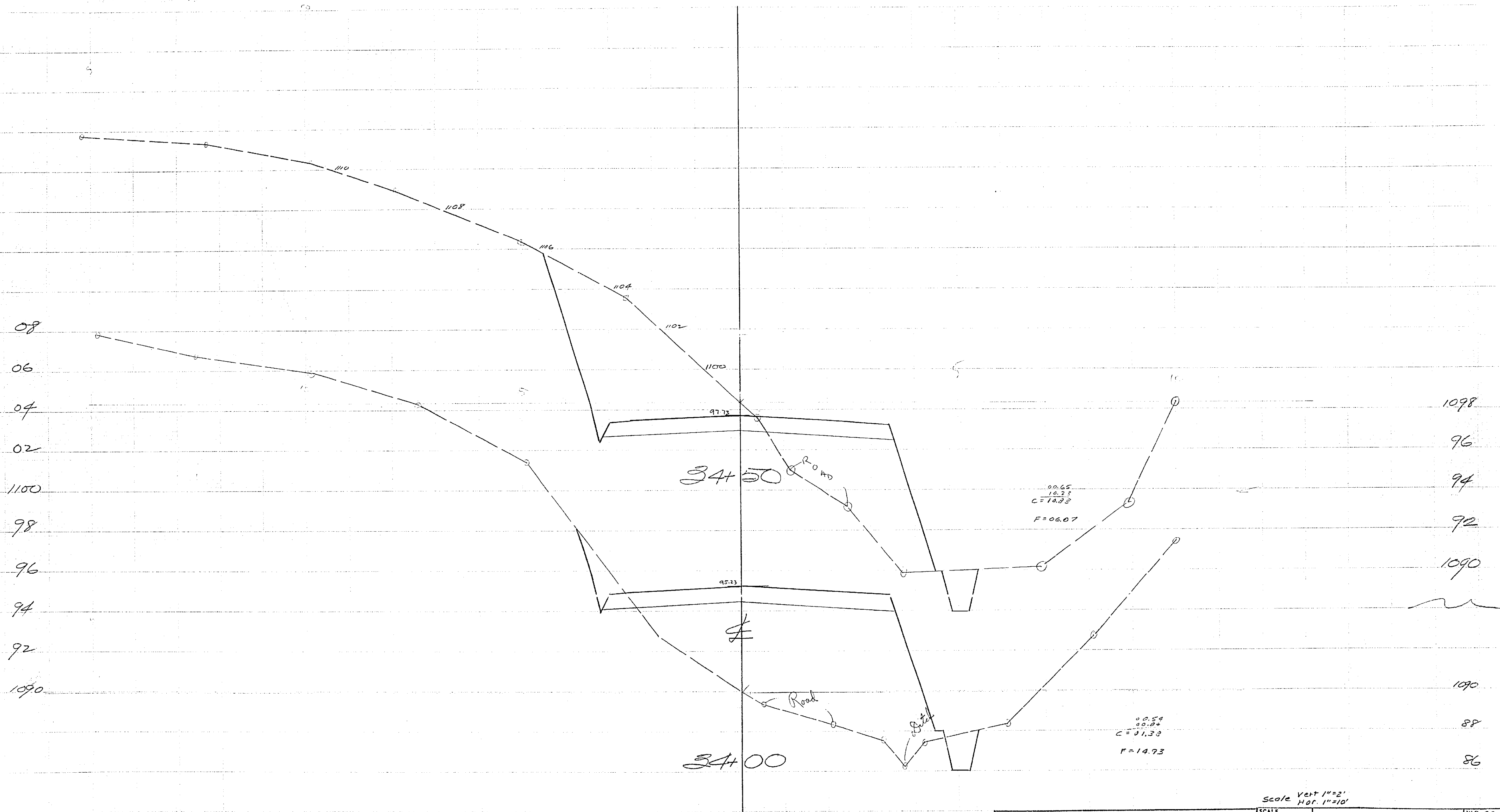

CITY OF RIVERSIDE
 CROSS SECTIONS
 ARLINGTON AVENUE BETWEEN
 VICTORIA AVE. & ALESSANDRO BLVD

Scale Vert 1"=2' Hor. 1"=10'		DATE 7-63	ALBERT A. WEBB ASSOCIATES	W.O. 20-115
DRAWN	CIVIL ENGINEER	CHECKED	RIVERSIDE CALIFORNIA	SHEET 33
CHECKED				OF SHEETS
				DWG. NO.

1164

1164

15

1102
1100
98
96
94
92
1090

1088
86
84
87
1088
86
84
82

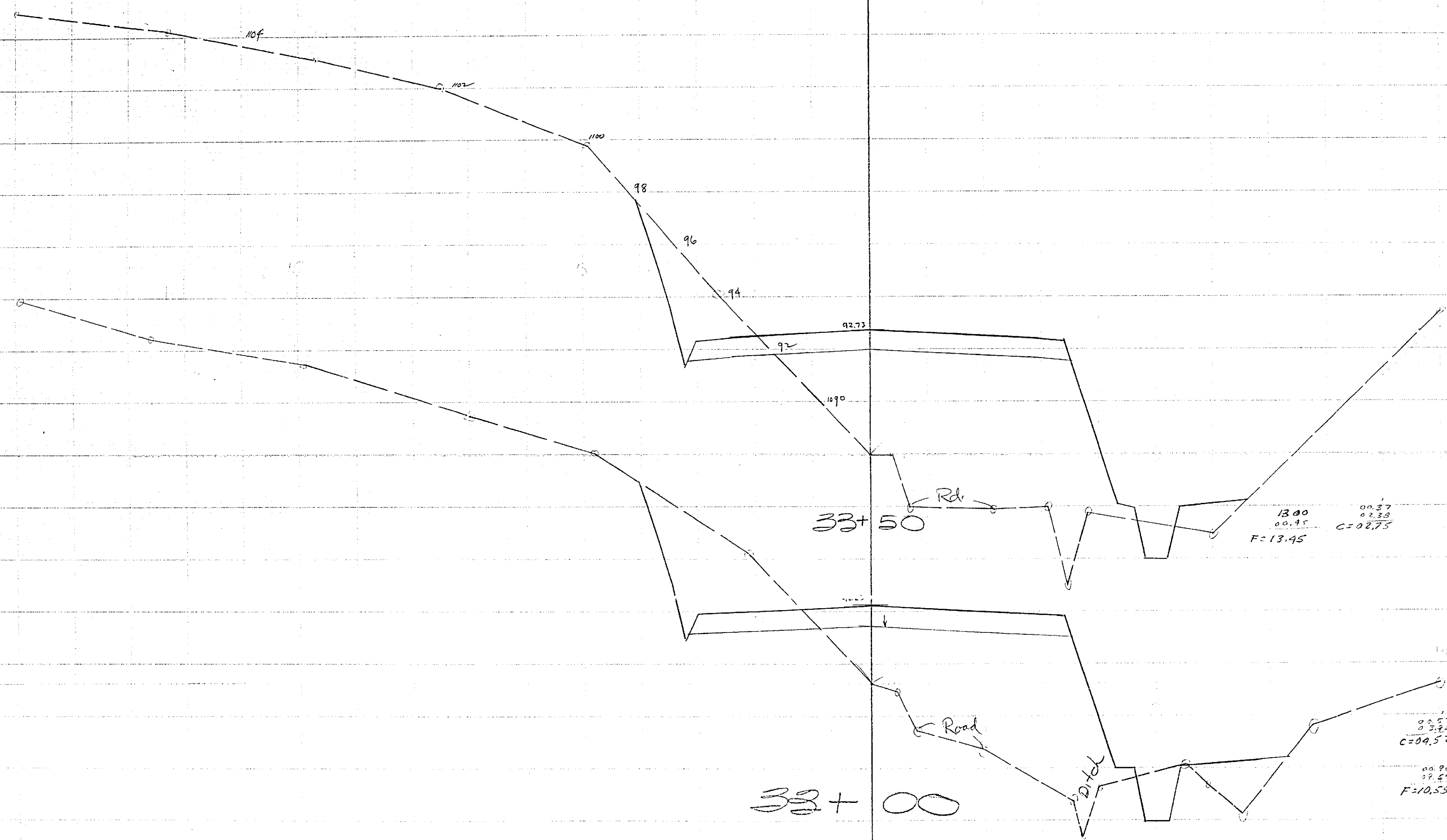

33+00

33+50

1080 Scale Vert 1"=2'
Hor. 1"=10'

CITY OF RIVERSIDE		ALBERT A. WEBB ASSOCIATES CIVIL ENGINEERS		W.O. 60-115
GROSS SECTIONS ARLINGTON AVENUE BETWEEN VICTORIA AVE. & ALESSANDRO BLVD		DATE 7-63	RIVERSIDE CALIFORNIA	SHEET 32
DRAWN		CHECKED		OF SHEETS
TRACED		F.B.		DWG. NO.

1164

1164

1164

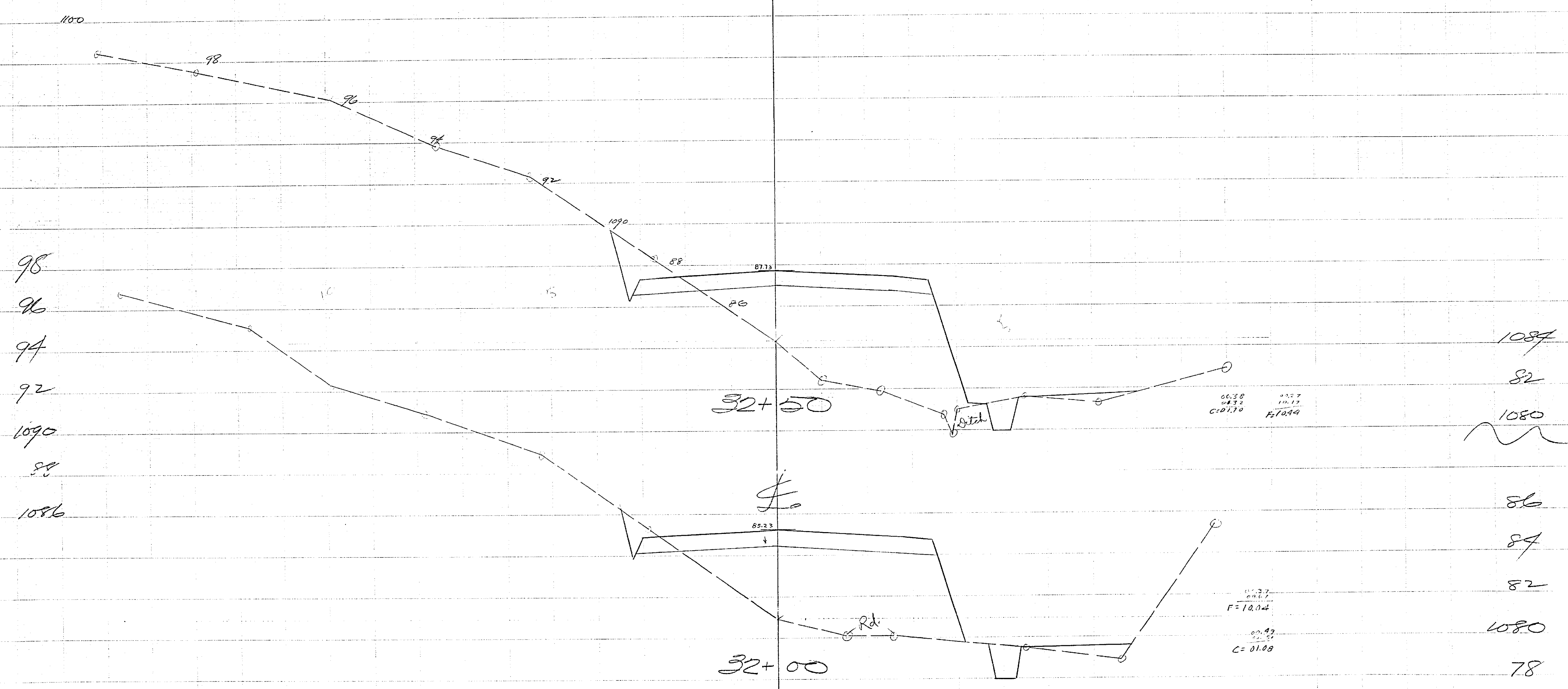

Scale Vert. 1"=2'
Hor. 1"=10'

CITY OF RIVERSIDE		SCALE	W.O. 60-115
CROSS SECTIONS		DATE 7-63	SHEET 31
ARLINGTON AVENUE BETWEEN		DRAWN	OF SHEETS
VICTORIA AVE. & ALESSANDRO BLVD.		TRACED	DWG. NO.
		CHECKED	
		F.B.	
		RIVERSIDE	CALIFORNIA

ALBERT A. WEBB ASSOCIATES
CIVIL ENGINEERS

1164

1164

1164

09

02

11.00

98

96

94

92

1090

88

86

84

82

1080

1078

Road

FL 78.30

3450

FL 72.00

E=1.7.70

78

76

74

Scale Vert. 1"=2'
Hor. 1"=10'

CITY OF RIVERSIDE
 CROSS SECTIONS
 ARLINGTON AVENUE BETWEEN
 VICTORIA AVE. & ALESSANDRO BLVD

SCALE
 DATE 7-68
 DRAWN
 TRACED
 CHECKED
 F.B.
 ALBERT A. WEBB ASSOCIATES
 CIVIL ENGINEERS
 RIVERSIDE CALIFORNIA

W.O. 60-115
 SHEET 30
 OF SHEETS
 DWG. NO.

1164

1164

1164

1102

1100

98

96

94

92

1090

88

86

84

82

1080

78

1076

10

05

31+00

80.24

F=67.34
C=01.80

1076

74

72

Scale Vert: 1"=2'
Hor: 1"=10'

CITY OF RIVERSIDE		ALBERT A. WEBB ASSOCIATES CIVIL ENGINEERS	W.D. 60-115
CROSS SECTIONS ARLINGTON AVENUE BETWEEN VICTORIA AVE. & ALESSANDRO BLVD		RIVERSIDE CALIFORNIA	SHEET 29
SCALE	DATE 1-63		OF SHEETS
DRAWN			DWG. NO.
TRACED			
CHECKED			
P.D.			

1164

1164

1100

98

96

94

92

1090

88

86

84

82

1080

10

5

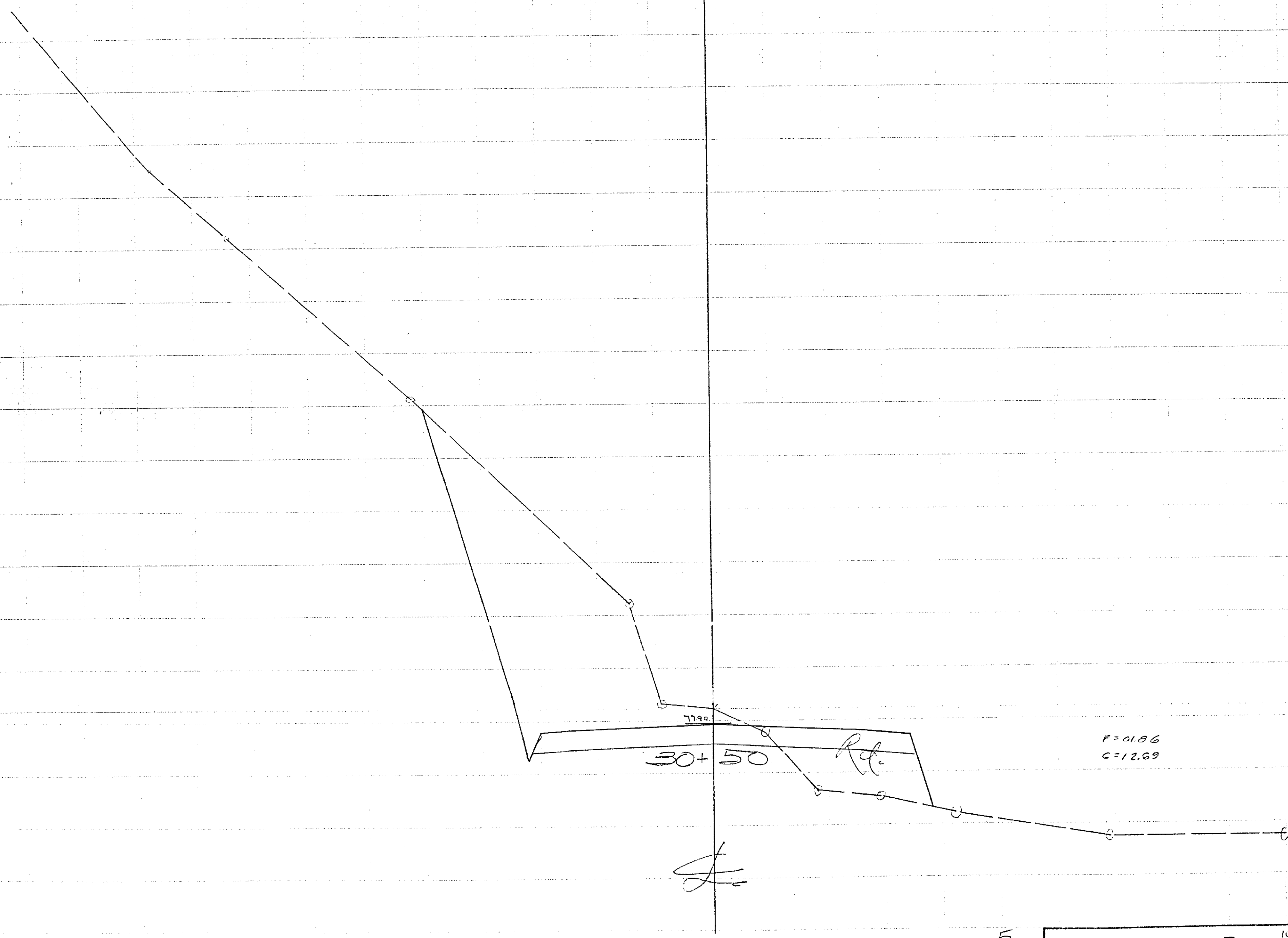

CITY OF RIVERSIDE		SCALE	ALBERT A. WEBB ASSOCIATES	W.G. 60-115
CROSS SECTIONS		DATE 7-63	CIVIL ENGINEERS	SHEET 28
ARLINGTON AVENUE BETWEEN		DRAWN	RIVERSIDE	OF SHEETS
VICTORIA AVE. & ALESSANDRO BLVD.		TRACED	CALIFORNIA	DWG. NO.
		CHECKED		
		F.B.		

1164

+911

1104

02

1100

98

96

94

92

1090

88

86

84

82

1080

1080

78

76

74

72

30+00

75.47

C=27.53

Scale Vert. 1"=2'
Hor. 1"=10'

CITY OF RIVERSIDE		SCALE	ALBERT & WEBB ASSOCIATES	NO. 60-115
CROSS SECTIONS		DATE 7-63	CIVIL ENGINEERS	SHEET 27
ARLINGTON AVENUE BETWEEN		DRAWN	RIVERSIDE CALIFORNIA	OF SHEETS
VICTORIA AVE. & ALESSANDRO BLVD.		TRACED		DWG. NO.
		CHECKED		
		F.B.		

1164

1164

06
04
02
1100
98
96
94
92
1090
88
86
84
82
1080

1080
78
76
74
72
1070
68

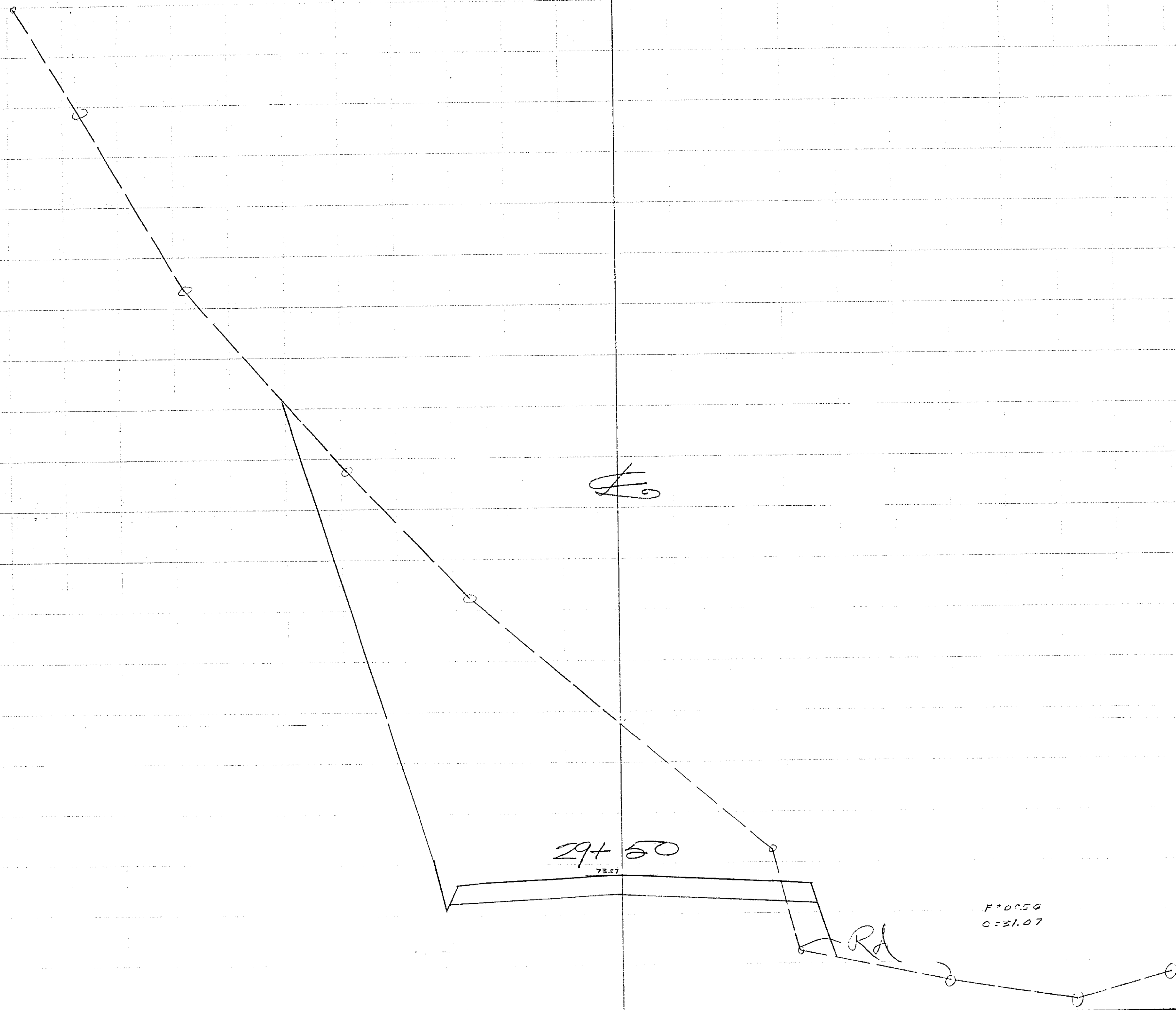

CITY OF RIVERSIDE
 CROSS SECTIONS
 ARLINGTON AVENUE BETWEEN
 VICTORIA AVE. & ALESSANDRO BLVD.

SCALE	Vert. 1"=2'	Hor. 1"=10'
DATE	1-63	
DRAWN		
TRACED		
CHECKED		
F.D.		
ALBERT A. WEBB ASSOCIATES CIVIL ENGINEERS		NO. 20-115 SHEET 26
RIVERSIDE CALIFORNIA		OF SHEETS DWG. NO.

1164

1164

1164

CLEVELAND DYKES CO.

CLEVELAND DYKES CO.

CLEVELAND DYKES CO.

110 08 06 04 02 1100 98 96 94 92 1090 88 86 84 82 1080 78 76 1074

1074 72 1070 68 66

F=0.128
C=30.42

Top of Wall

Rd

29+00

Scale Vert 1"=2'
Hor 1"=10'

CITY OF RIVERSIDE		ALBERT A. WEBB ASSOCIATES CIVIL ENGINEERS		W.O. 60-115
CROSS SECTIONS		RIVERSIDE, CALIFORNIA		SHEET 25
ARLINGTON AVENUE BETWEEN		1164		OF SHEETS
VICTORIA AVE. & ALESSANDRO BLVD.				DWG. NO.
SCALE	DATE 7-53			
DRAWN				
TRACED				
CHECKED				
P.R.				

1164

1164

02 15
20

1100

98

96

94

92

1090

88

86

84

82

1080

78

76

74

72

1070

CIVIL ENGINEERS

CIVIL ENGINEERS

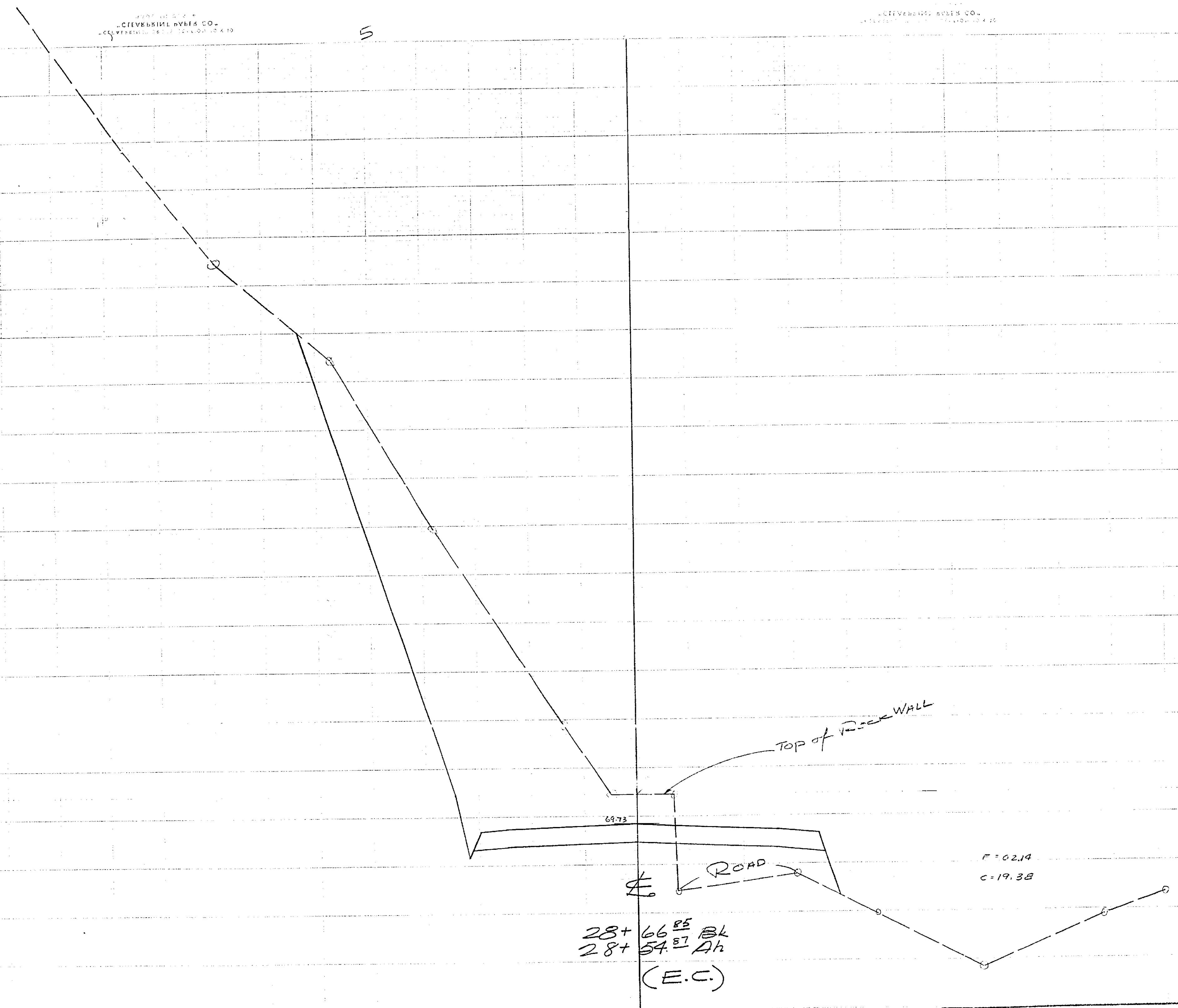

1070

68

66

64

62

Scale Vert. 1"=2'
Hor. 1"=10'

CITY OF RIVERSIDE
 CROSS SECTIONS
 ARLINGTON AVENUE BETWEEN
 VICTORIA AVE & ALESSANDRO BLVD.

SCALE	DATE 7-68	ALBERT A. WEBB ASSOCIATES	W.D. 60-115
DRAWN	TRACED	CIVIL ENGINEERS	SHEET 24
CHECKED	F.B.	RIVERSIDE CALIFORNIA	OF SHEETS
			DWG. NO.

1164

1164

07
02
1100
98
96
94
92
1090
88
86
84
82
1080
78
76
74
72
1070

CLEVELAND ENGINEERING & SURVEYING CO.

CLEVELAND ENGINEERING & SURVEYING CO.

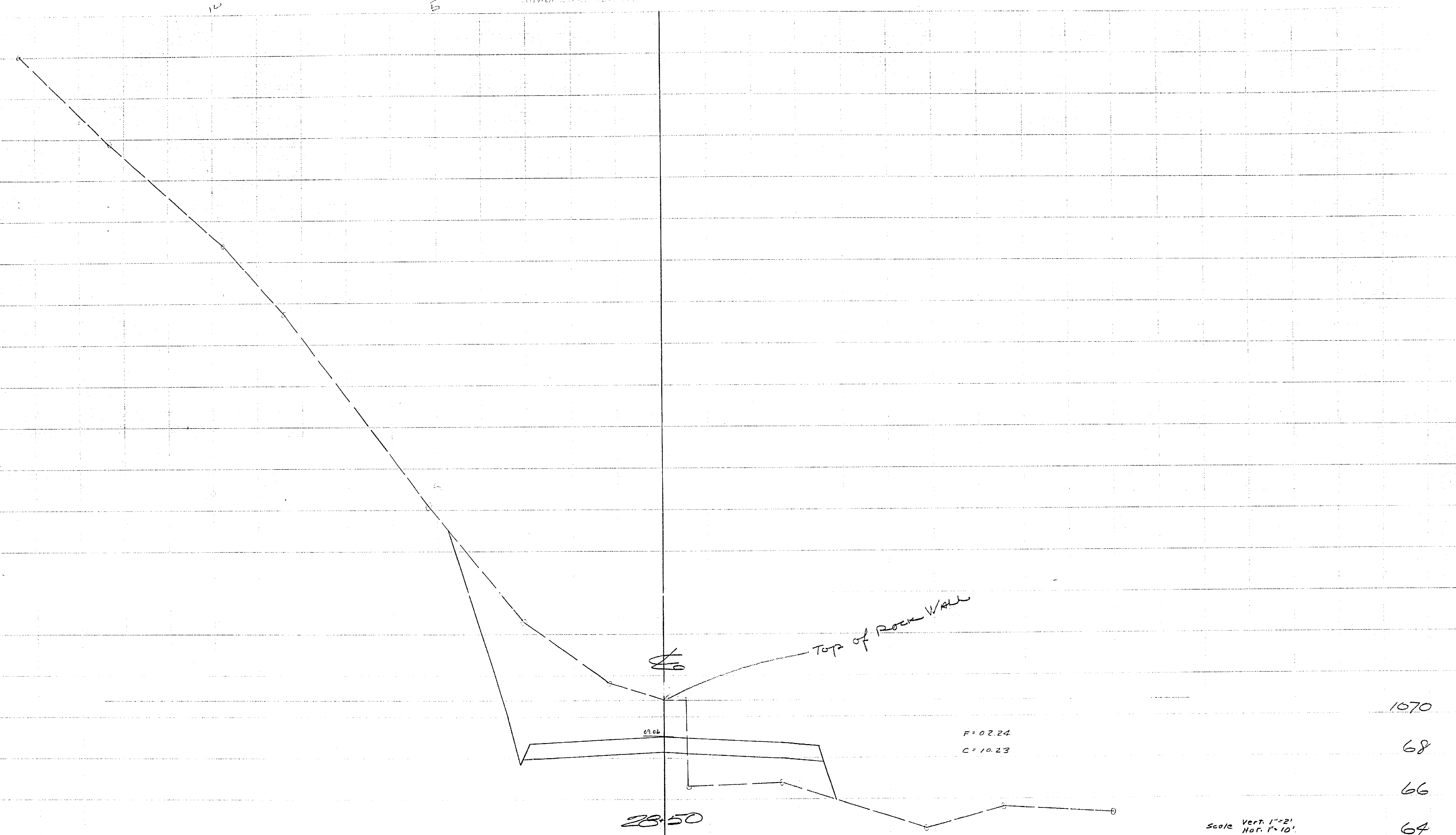

Top of Rock Wall

F=02.24
C=10.23

28+50

1070
68
66
64

Scale Vert. 1"=2'
Hor. 1"=10'

CITY OF RIVERSIDE		SCALE	W.D. 60-115
CROSS SECTIONS		DATE 1-63	SHEET 23
ARLINGTON AVENUE BETWEEN		DRAWN	OF SHEETS
VICTORIA AVE. & ALESSANDRO BLVD		TRACED	DWG. NO.
		CHECKED	
		F.B.	
		ALBERT A. WEBB ASSOCIATES CIVIL ENGINEERS RIVERSIDE CALIFORNIA	

1164

1164

1164

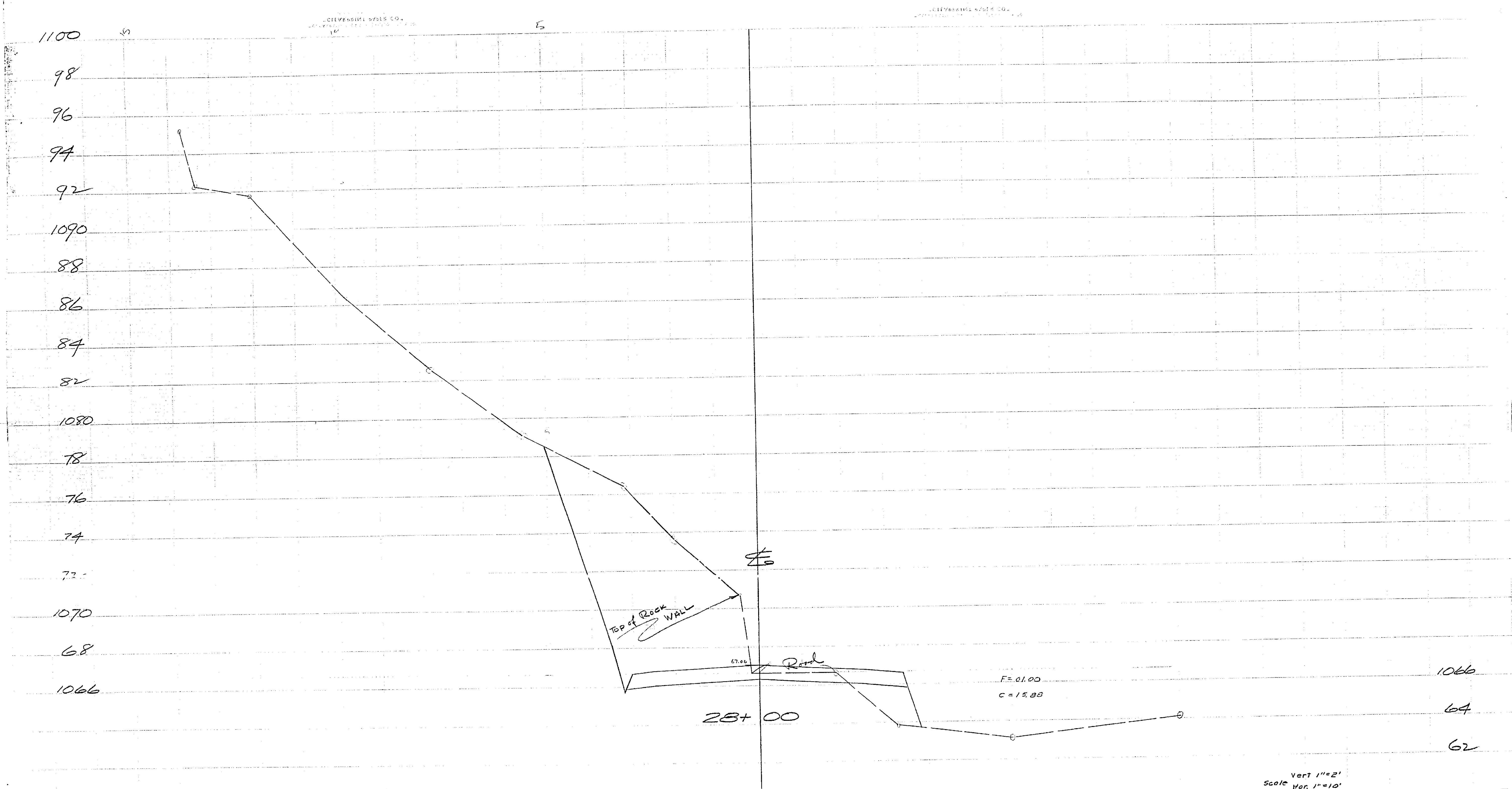

1164

CITY OF RIVERSIDE		SCALE	ALBERT A. WEBB ASSOCIATES	W.O. 60-115
CROSS SECTIONS		DATE 7-63	CIVIL ENGINEERS	SHEET 22
ARLINGTON AVENUE BETWEEN		DRAWN	RIVERSIDE	OF SHEETS
VICTORIA AVE. & ALESSANDRO BLVD.		TRACED	CALIFORNIA	DWG. NO.
		CHECKED	1164	
		F.B.		

Vert 1"=2'
Scale Hor. 1"=10'

1164

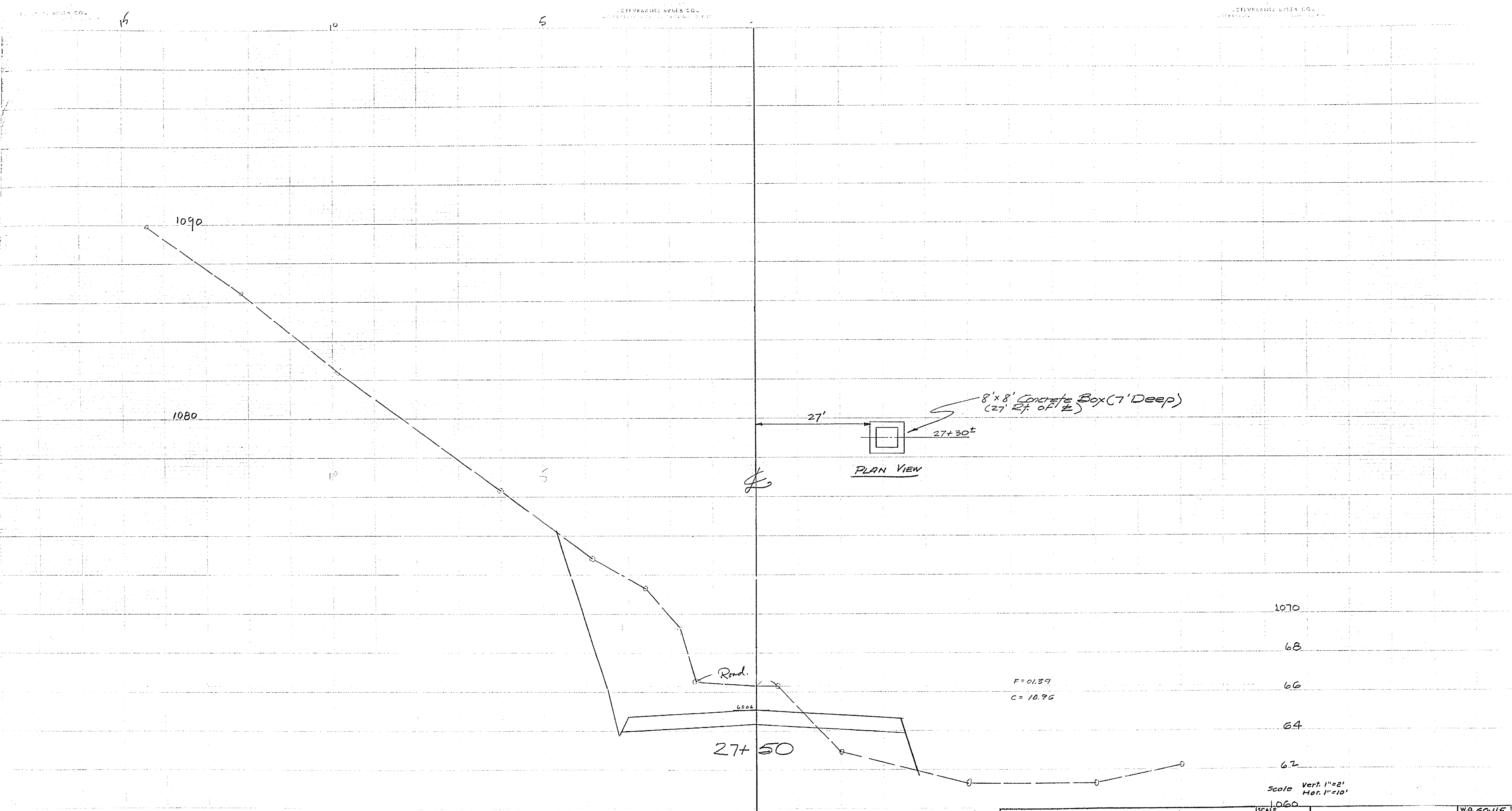

1164

CITY OF RIVERSIDE		W.O. 60-115
CROSS SECTIONS		SHEET 21
ARLINGTON AVENUE BETWEEN		OF SHEETS
VICTORIA AVE. & ALESSANDRO BLVD		DWG. NO.
SCALE	DATE 1-63	ALBERT A. WEBB ASSOCIATES CIVIL ENGINEERS 1164
DRAWN		
TRACED		
CHECKED		
P.D.		

1164

CLEVELAND RYAN CO.
CIVIL ENGINEERS

CLEVELAND RYAN CO.
CIVIL ENGINEERS

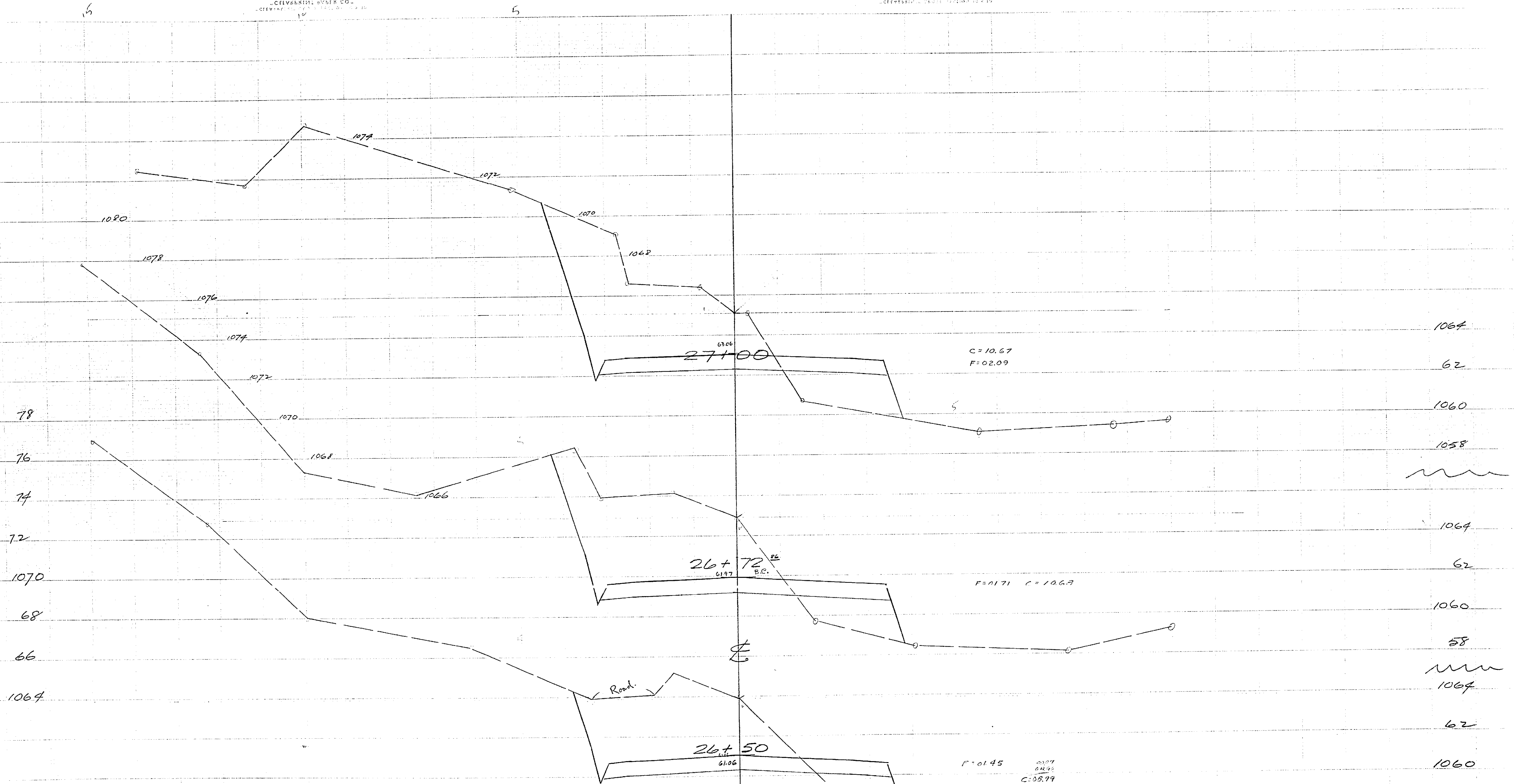

CITY OF RIVERSIDE
 CROSS SECTIONS
 ARLINGTON AVENUE BETWEEN
 VICTORIA AVE. & ALESSANDRO BLVD.

Scale Vert. 1"=2'
Hor. 1"=10'

SCALE	DATE 7-63	ALBERT A. WEBB ASSOCIATES CIVIL ENGINEERS	W.O. 60-115
DRAWN	CHECKED 7/05	RIVERSIDE CALIFORNIA	SHEET 20
TRACED			OF SHEETS
F.S.			UWG. NO.

1164

1164

1164

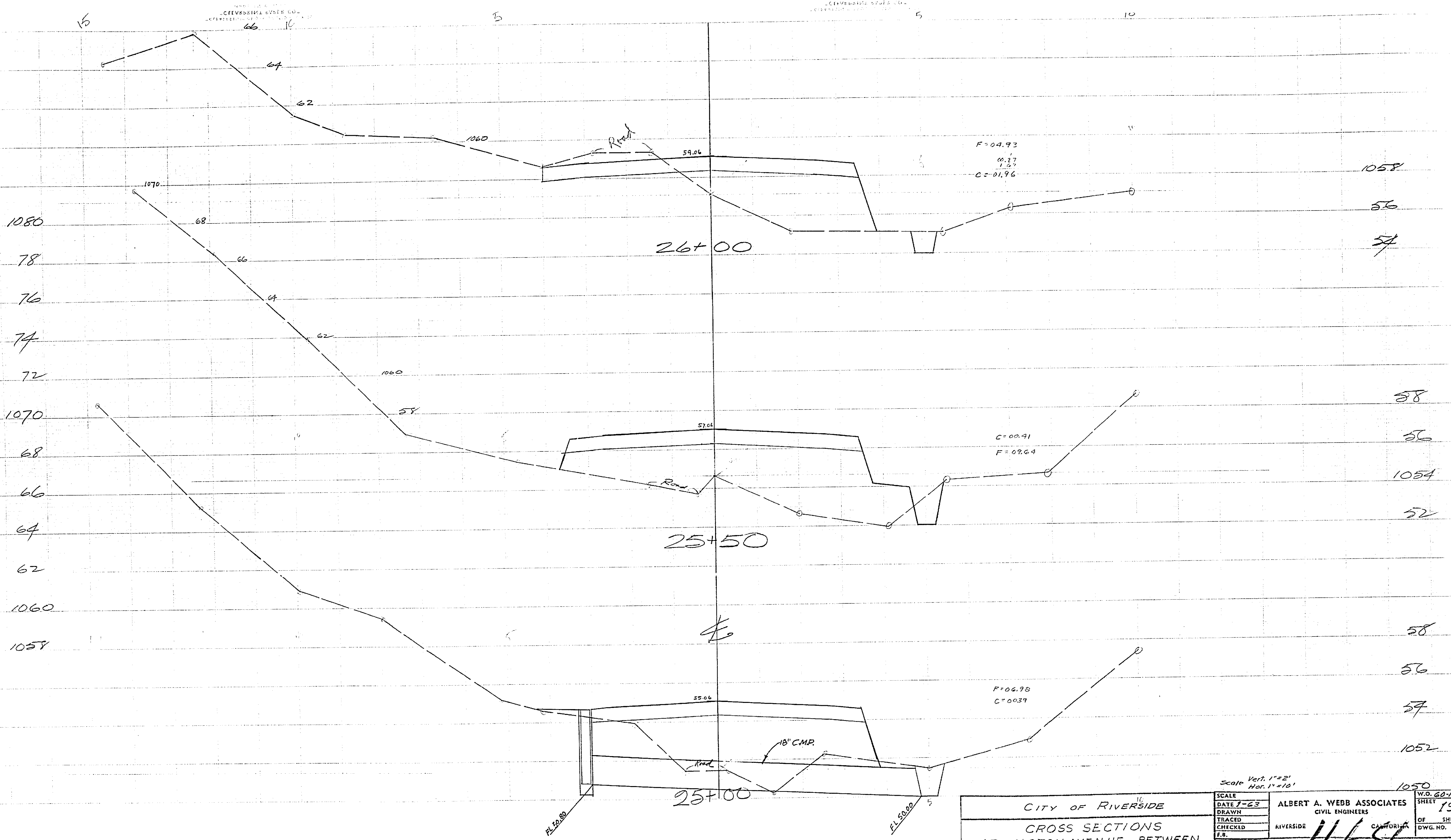

CITY OF RIVERSIDE
 CROSS SECTIONS
 ARLINGTON AVENUE BETWEEN
 VICTORIA AVE. & ALESSANDRO BLVD.

Scale Vert. 1"=2'
 Hor. 1"=10'

SCALE	DATE 1-63	ALBERT A. WEBB ASSOCIATES CIVIL ENGINEERS	W.O. 60-115
DRAWN			SHEET 19
TRACED			OF SHEETS
CHECKED		RIVERSIDE	DWG. NO.
F.R.			

1164

1164

1164

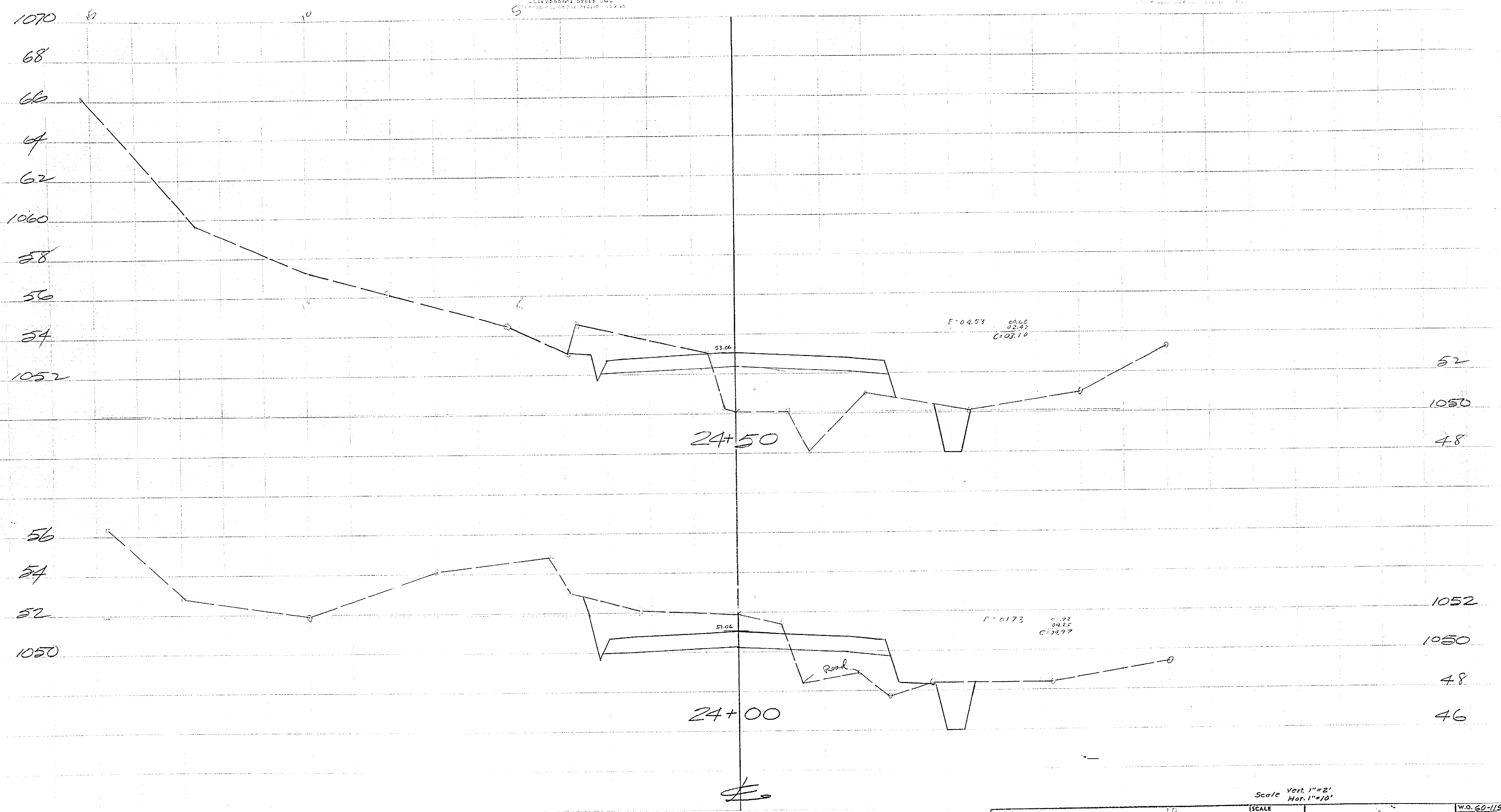

1164

CITY OF RIVERSIDE		SCALE	W.O. 60-115
CROSS SECTIONS		DATE 7-63	SHEET 18
ARLINGTON AVENUE BETWEEN		DRAWN	OF SHEETS
VICTORIA AVE. & ALESSANDRO BLVD.		TRACED	DWG. NO.
		CHECKED	
		P.B.	
		ALBERT A. WEBB ASSOCIATES CIVIL ENGINEERS	
		RIVERSIDE CALIFORNIA	

Scale: Vert. 1"=2', Hor. 1"=10'

1164

1164

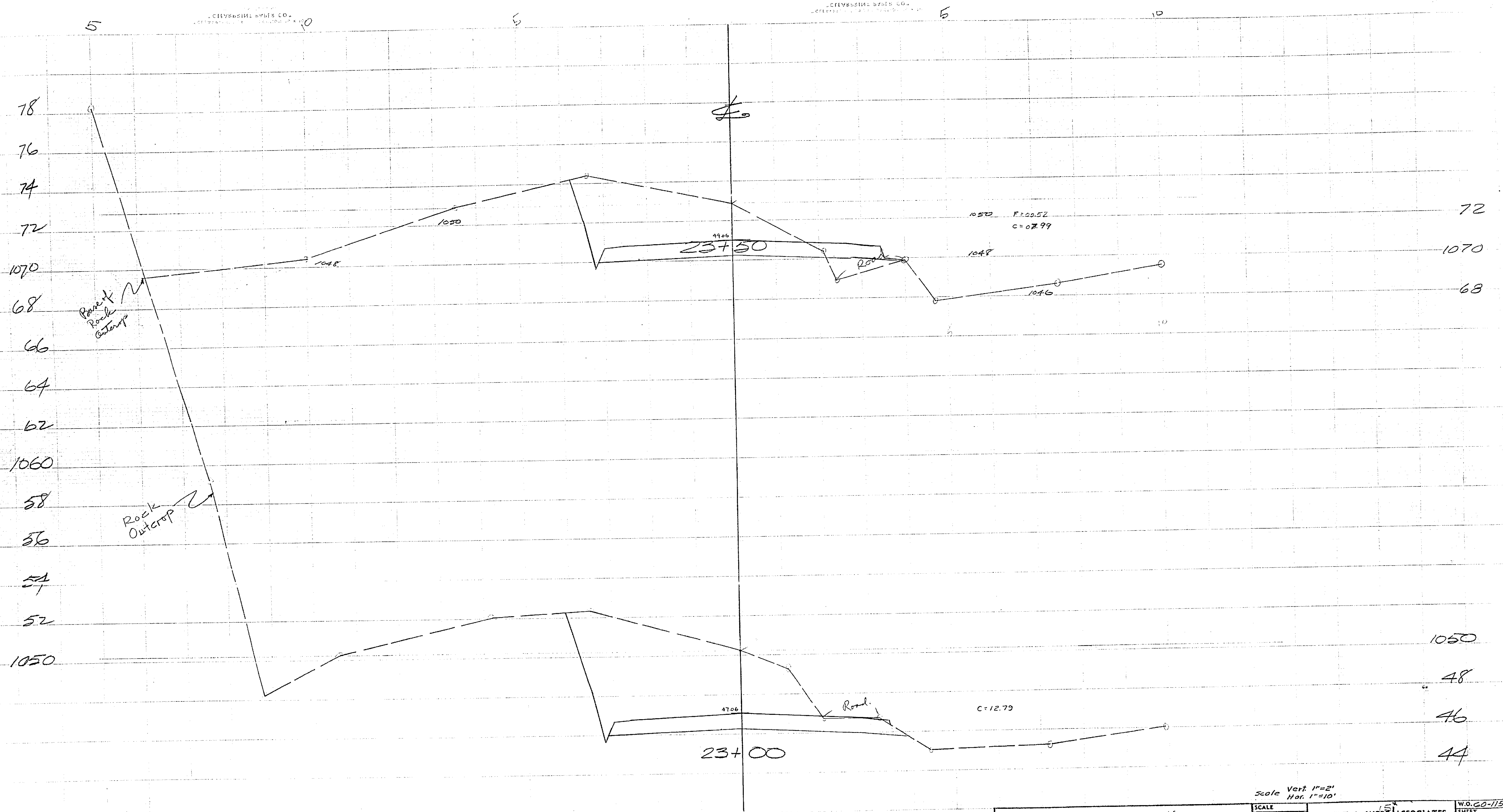

1164

CITY OF RIVERSIDE
 CROSS SECTIONS
 ARLINGTON AVENUE BETWEEN
 VICTORIA AVE & ALESSANDRO BLVD.

Scale Vert 1"=2'
 Hor. 1"=10'

SCALE	DATE 1-63	ALBERT A. WEBB ASSOCIATES	W.O. 60-115
DRAWN		CIVIL ENGINEERS	SHEET 17
TRACED			OF SHEETS
CHECKED		RIVERSIDE	DWG. NO.
T.B.			

1164

1164

CITY OF RIVERSIDE
ENGINEERING DEPARTMENT

CITY OF RIVERSIDE
ENGINEERING DEPARTMENT

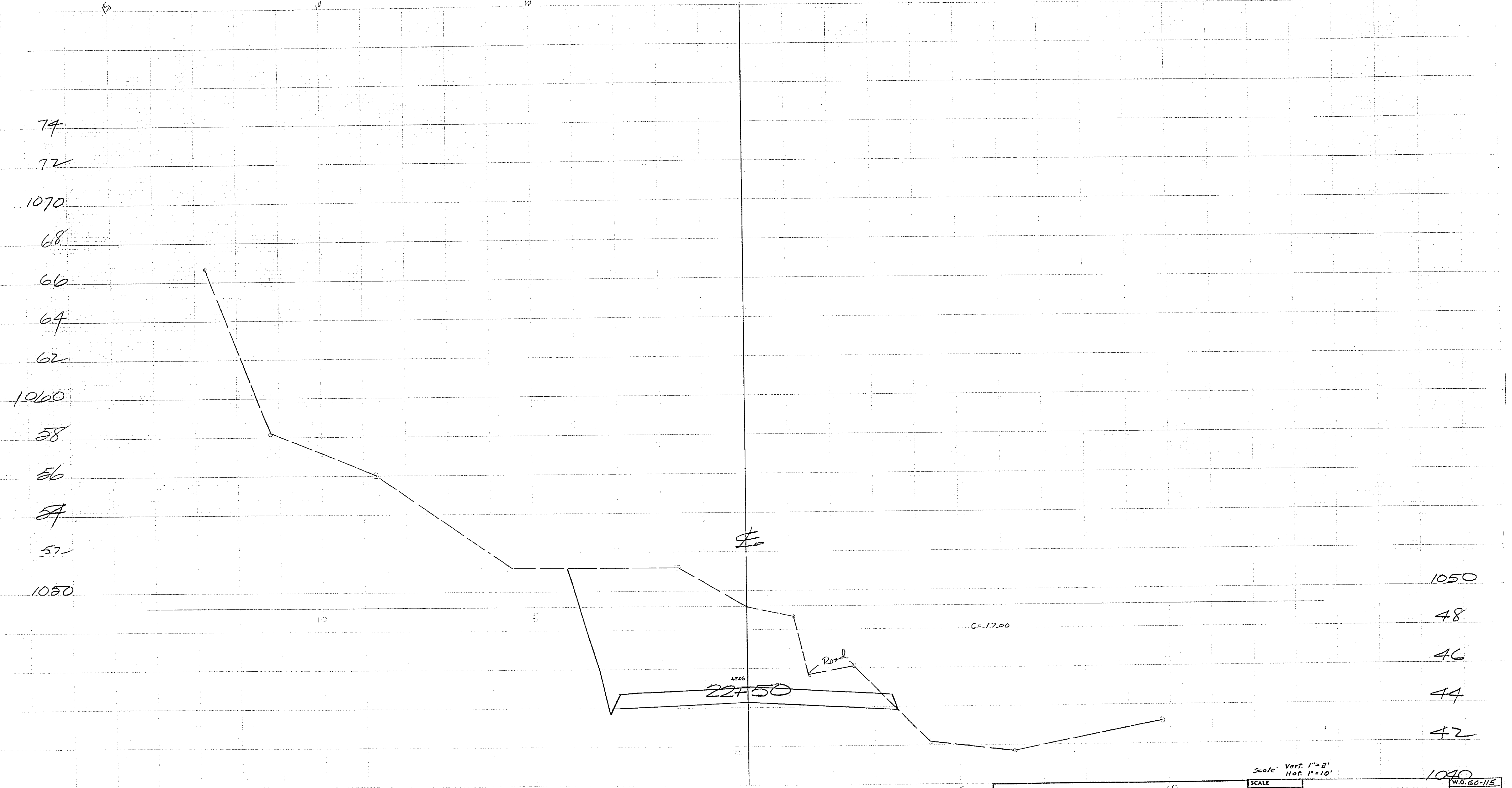

1164

CITY OF RIVERSIDE
 CROSS SECTIONS
 ARLINGTON AVENUE BETWEEN
 VICTORIA AVE. & ALESSANDRO BLVD.

Scale: Vert. 1"=2'
Hor. 1"=10'

SCALE	DATE 1-63	ALBERT A. WEBB ASSOCIATES CIVIL ENGINEERS	W.O. 60-115 SHEET 16
DRAWN		RIVERSIDE	OF SHEETS
TRACED		CAJON	DWG. NO.
CHECKED			
P.R.			

1040
1164

1164

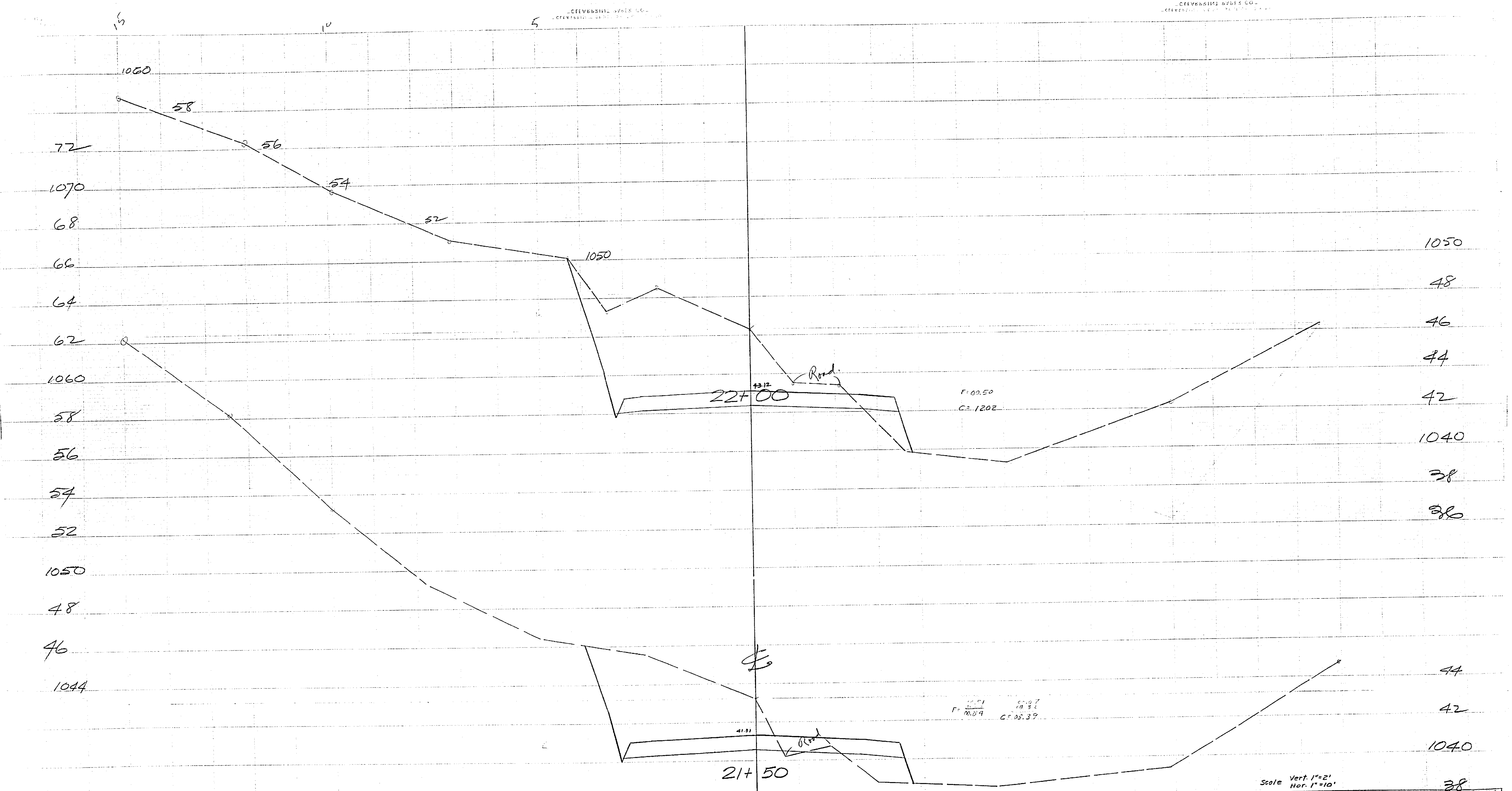

CITY OF RIVERSIDE		SCALE	Vert. 1"=2'	Hor. 1"=10'	38
CROSS SECTIONS		DATE			W.O. 60-115
ARLINGTON AVENUE BETWEEN		DRAWN			SHEET 15
VICTORIA AVE. & ALESSANDRO BLVD.		TRACED			OF SHEETS
		CHECKED			DWG. NO.
		F.B.			

ALBERT A. WEBB ASSOCIATES
CIVIL ENGINEERS
RIVERSIDE CALIFORNIA

1164

1164

1164

CITY OF RIVERSIDE

CITY OF RIVERSIDE

78
76
74
72
1070
68
66
64
62
1060
58
56
54
52
1050
48
46
1044

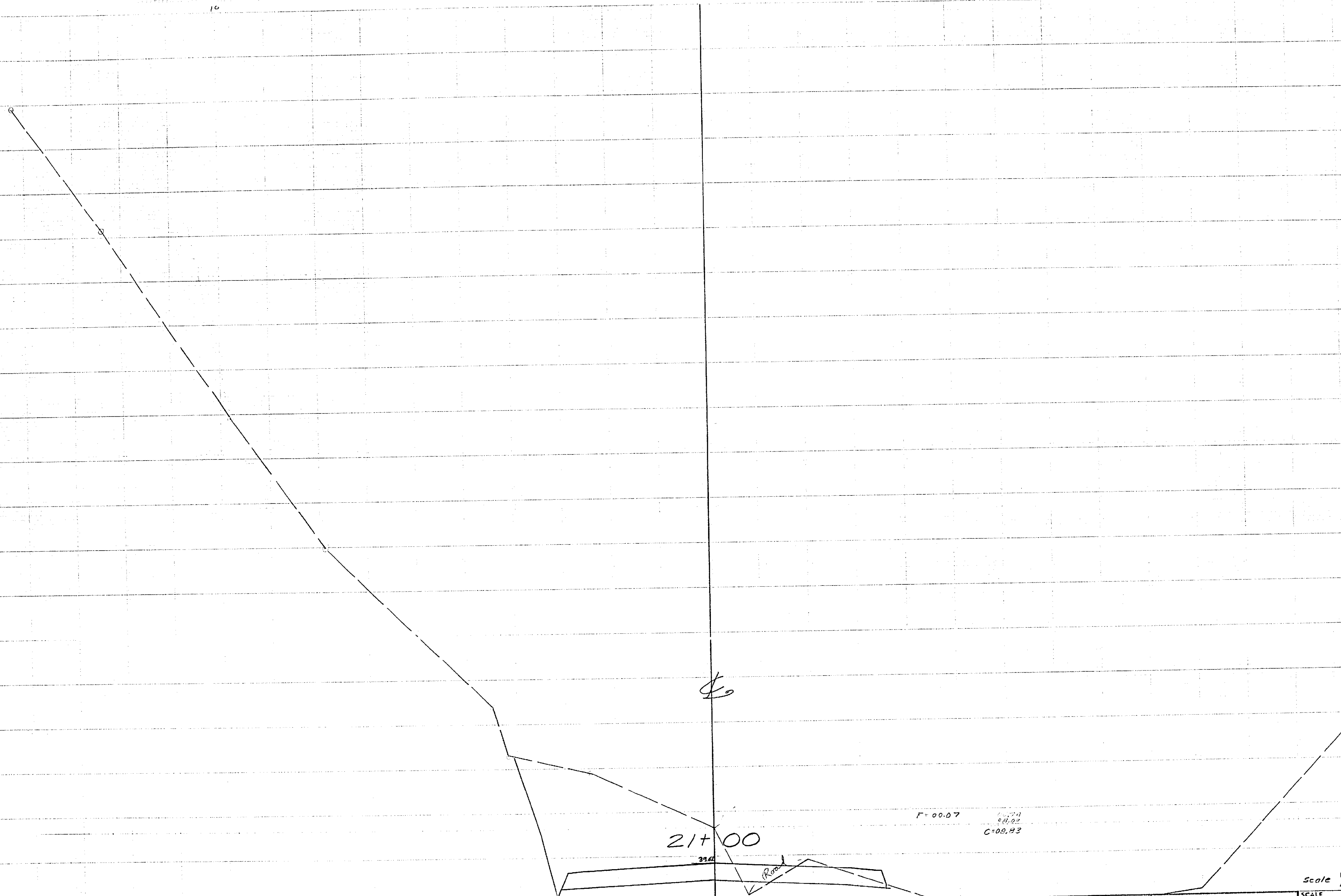

21+00

F=00.07
C=08.83

44
42
1040

Scale Vert. 1"=2'
Hor. 1"=10'

CITY OF RIVERSIDE
 CROSS SECTIONS
 ARLINGTON AVENUE BETWEEN
 VICTORIA AVE. & ALESSANDRO BLVD.

SCALE	ALBERT A. WEBB ASSOCIATES	W.O. 60-115
DATE 1-63	CIVIL ENGINEERS	SHEET 14
DRAWN		36 SHEETS
TRACED	RIVERSIDE CALIFORNIA	DWG. NO.
CHECKED		
F.B.		

1/64

1164

1164

CITY OF RIVERSIDE
ALBERT A. WEBB ASSOCIATES, CIVIL ENGINEERS

CITY OF RIVERSIDE
ALBERT A. WEBB ASSOCIATES, CIVIL ENGINEERS

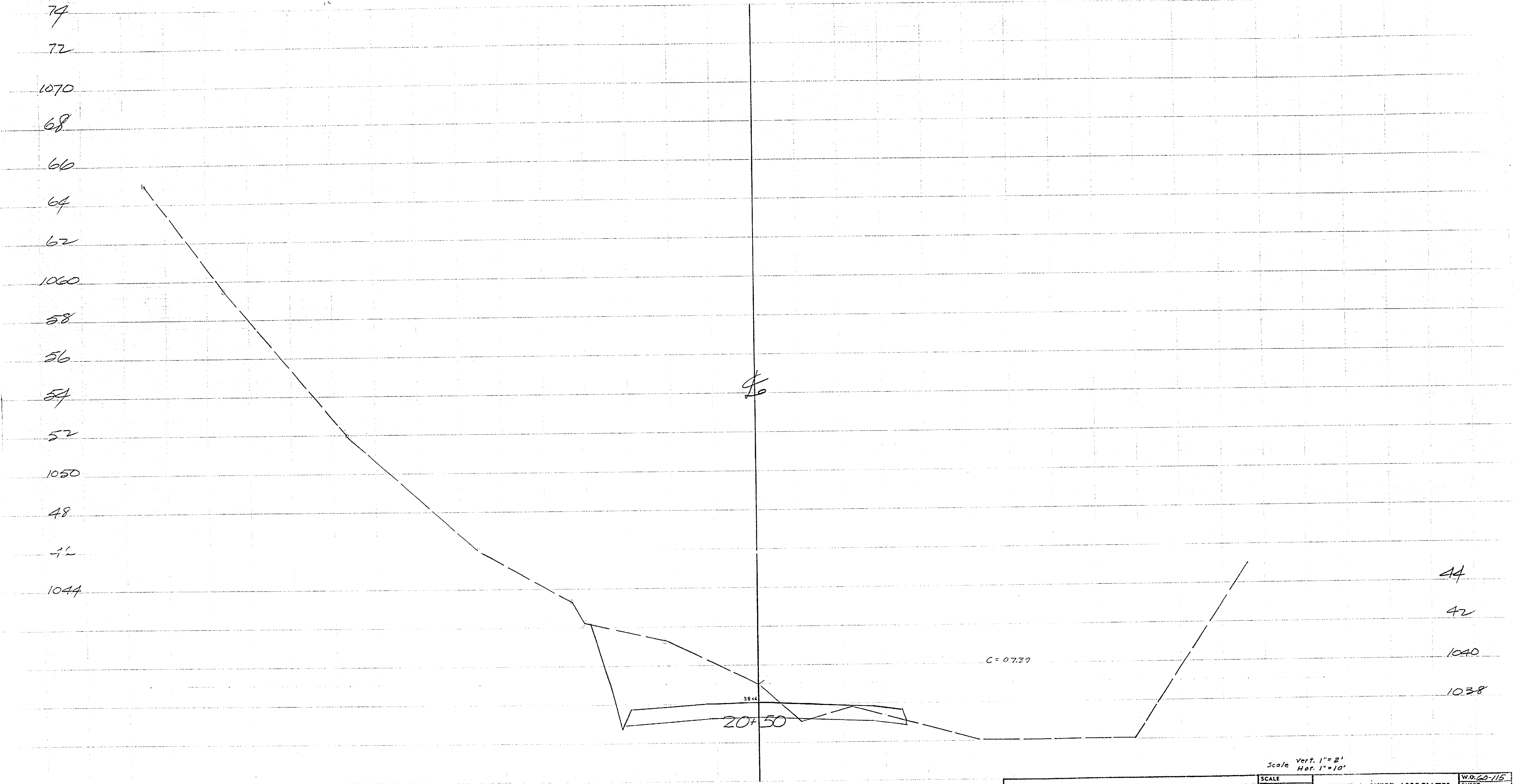

1164

CITY OF RIVERSIDE		ALBERT A. WEBB ASSOCIATES CIVIL ENGINEERS		W.O. 60-115
CROSS SECTIONS		RIVERSIDE CALIFORNIA		SHEET 13
ARLINGTON AVENUE BETWEEN VICTORIA AVE. & ALESSANDRO BLVD.		1164		OF SHEETS
SCALE	DATE 1-63			DWG. NO.
DRAWN	CHECKED			
TRACED	P.B.			

Scale Vert. 1" = 2'
Hor. 1" = 10'

7911

74

72

1070

68

66

64

62

1060

58

56

54

52

1050

48

46

44

42

1040

42

1040

38

1036

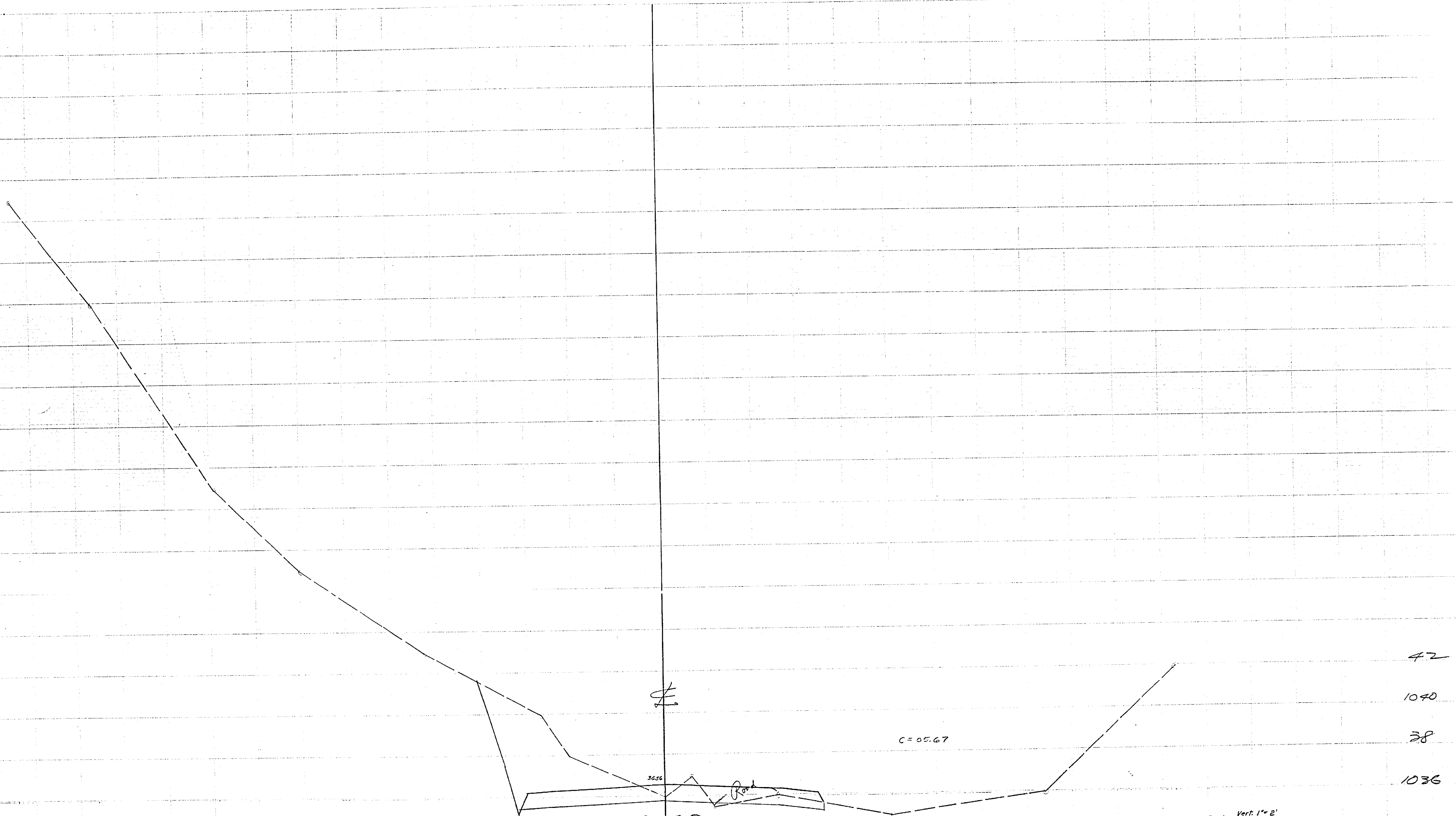

1164

CITY OF RIVERSIDE		SCALE	ALBERT A. WEBB ASSOCIATES	W.O. 60-115
CROSS SECTIONS		DATE 7-63	CIVIL ENGINEERS	SHEET 12
ARLINGTON AVENUE BETWEEN		DRAWN	RIVERSIDE	OF SHEETS
VICTORIA AVE. & ALESSANDRO BLVD		TRACED	CALIFORNIA	DWG. NO.
		CHECKED		
		P.B.		

1164

Scale Vert. 1"=2'
Hor. 1"=10'

1164

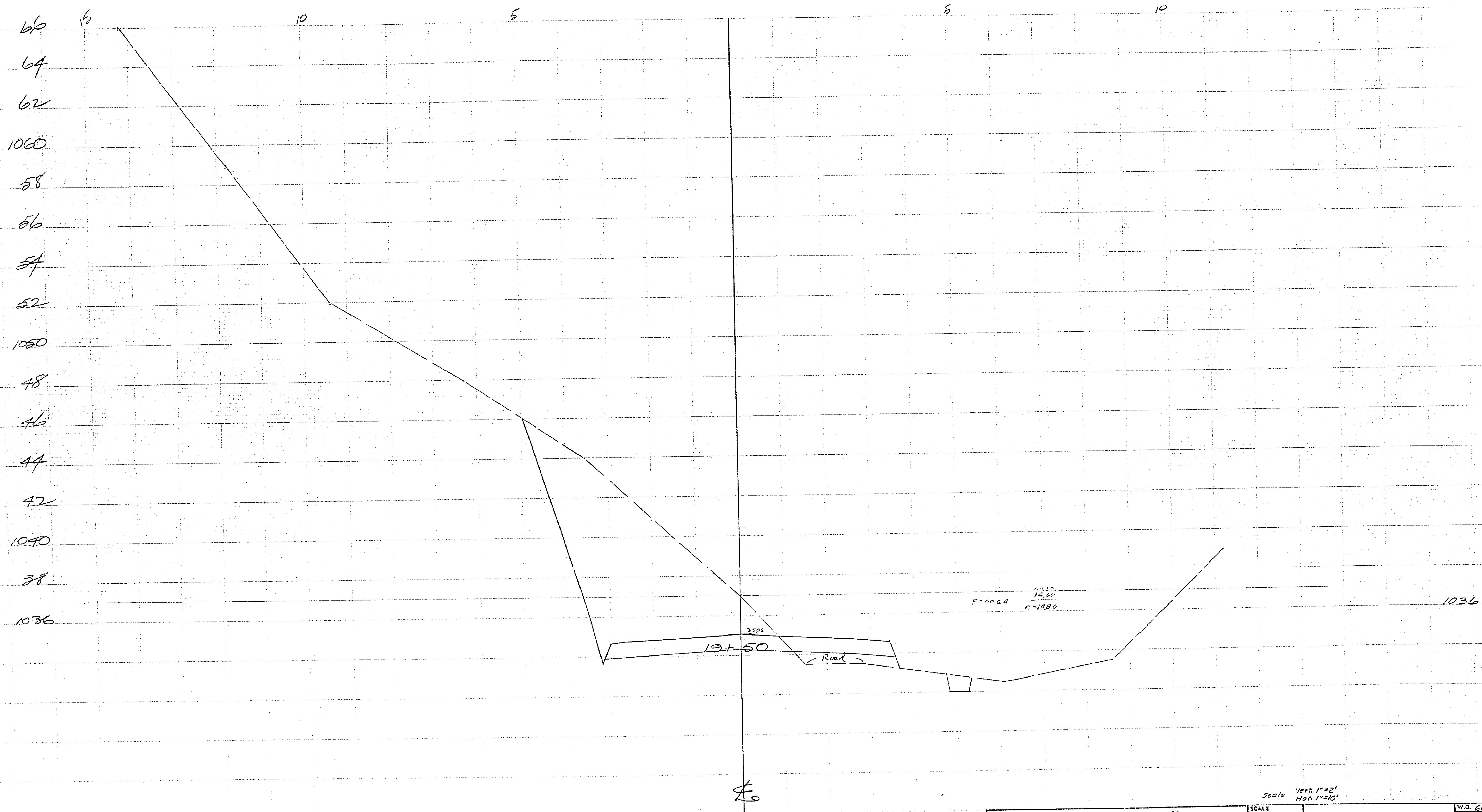

1164

CITY OF RIVERSIDE
 CROSS SECTIONS
 ARLINGTON AVENUE BETWEEN
 VICTORIA AVE. & ALESSANDRO BLVD.

Scale Vert. 1"=2'
 Hor. 1"=10'

SCALE	ALBERT A. WEBB ASSOCIATES	W.O. 60-115
DATE 1-63	CIVIL ENGINEERS	SHEET 11
DRAWN		OF SHEETS
TRACED	RIVERSIDE	CALIFORNIA DWG. NO.
CHECKED		
F.B.		

1164

1164

68
66
64
62
1060
58
56
54
52
1050
48
46
44
42
40
1038

1038
36
34
32
30
28

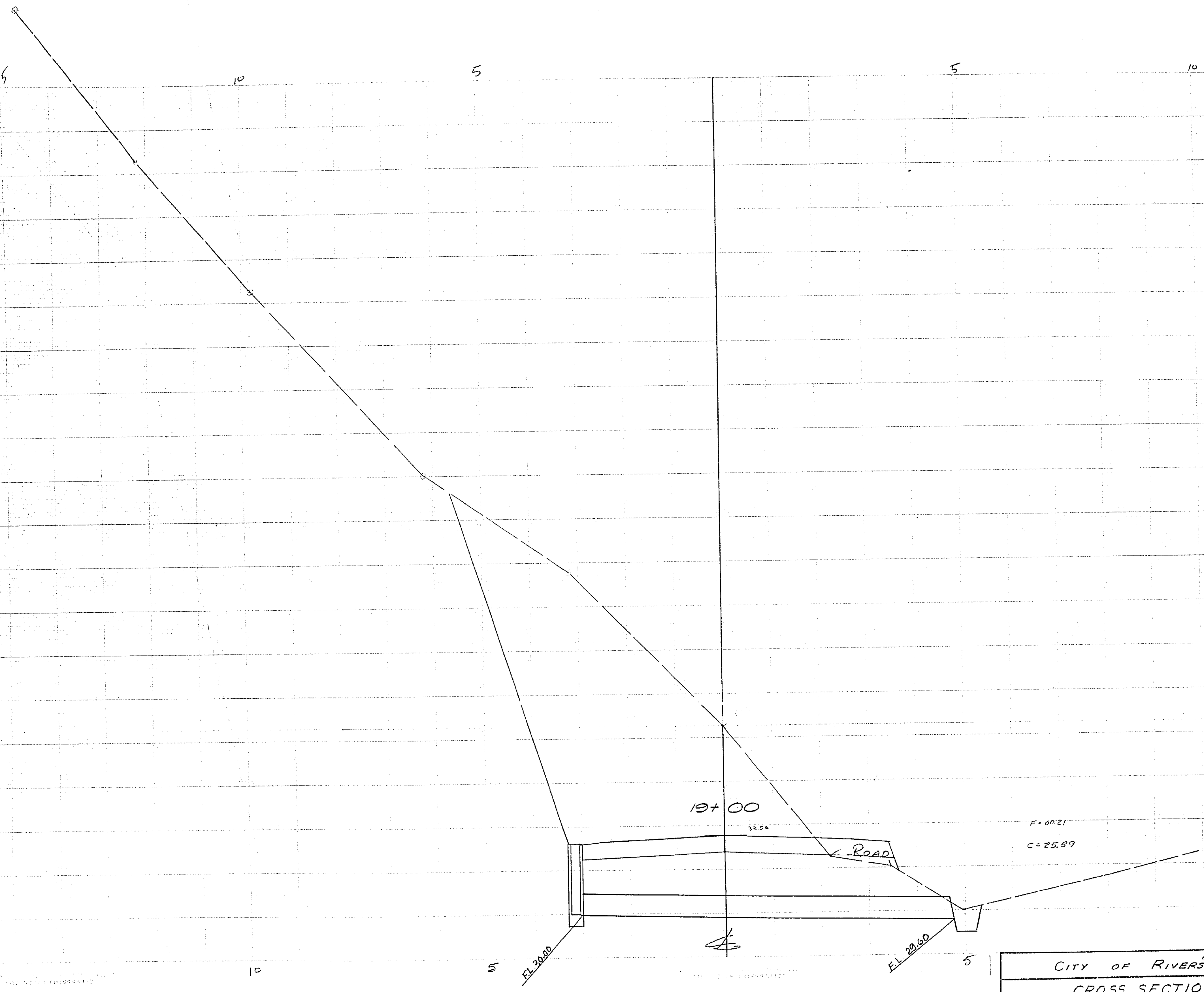

CITY OF RIVERSIDE
 CROSS SECTIONS
 ARLINGTON AVENUE BETWEEN
 VICTORIA AVE. & ALESSANDRO BLVD.

Scale Vert. 1"=2'
 Hor. 1"=10'

SCALE	ALBERT A. WEBB ASSOCIATES	W.O. 60-115
DATE 1-63	CIVIL ENGINEERS	SHEET 10.
DRAWN		OF SHEETS
TRACED	RIVERSIDE CALIFORNIA	DWG. NO.
CHECKED		
F.B.		

1164

1164

1164

68
66
64
62
1060
58
56
54
52
1050
48
46
44
42
40

10

5

5

10

1038

1038

18 + 50

36

E: 0010
00.29
33.22
C = 39.51

34

32.07

32

30

10

5

5

10

Scale Vert. 1"=2'
Hor. 1"=10'

CITY OF RIVERSIDE
CROSS SECTIONS
ARLINGTON AVENUE BETWEEN
VICTORIA AVE. & ALESSANDRO BLVD.

SCALE	DATE 7-63	ALBERT A. WEBB ASSOCIATES CIVIL ENGINEERS	W.O. 60-115
DRAWN			SHEET 9
TRACED			OF SHEETS
CHECKED		RIVERSIDE CALIFORNIA	DWG. NO.
P.B.			

1164

1164

1164

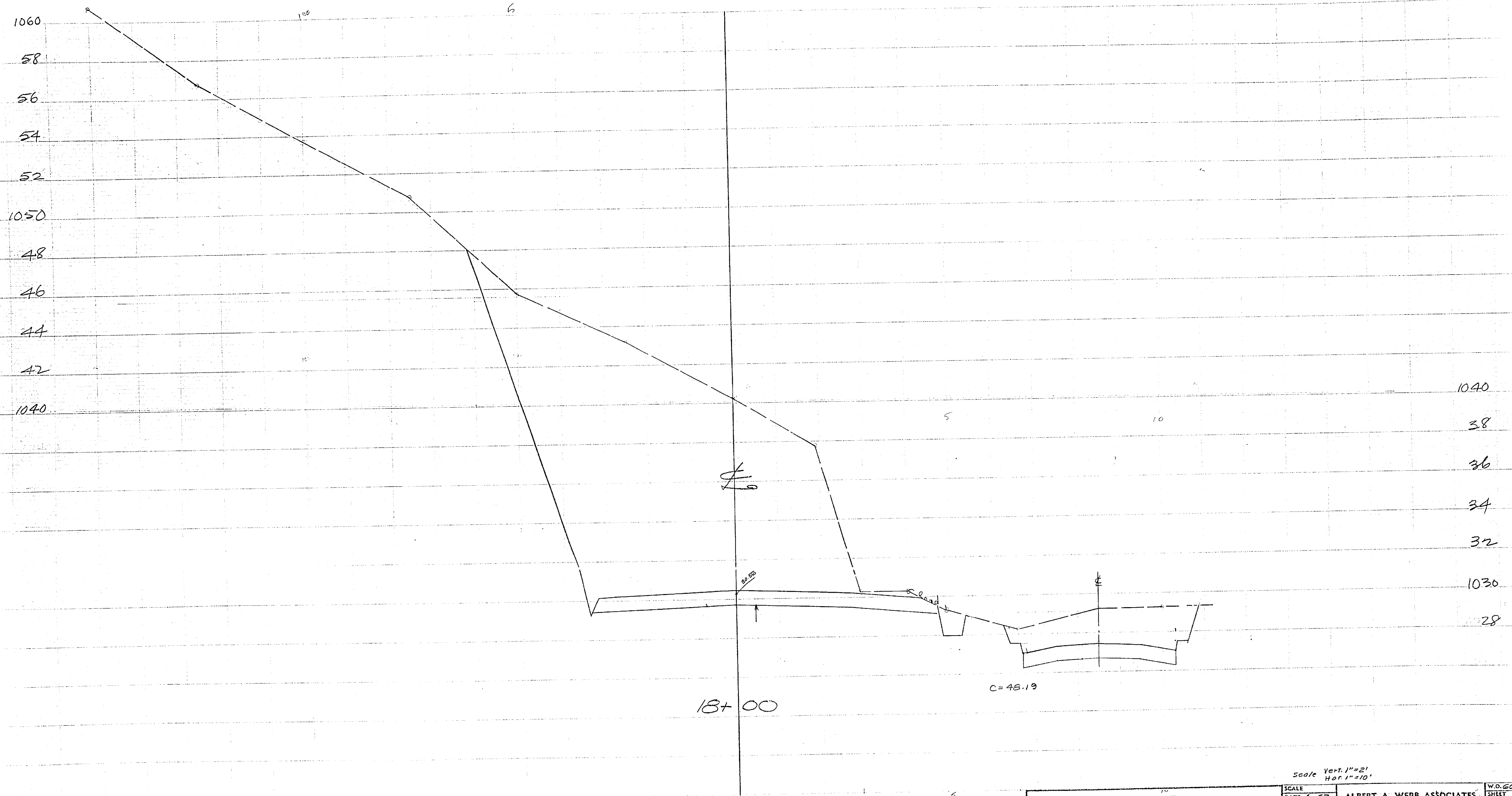

1164

CITY OF RIVERSIDE
 CROSS SECTIONS
 ARLINGTON AVENUE BETWEEN
 VICTORIA AVE. & ALESSANDRO BLVD.

Scale Vert. 1"=2'
 Hor. 1"=10'

SCALE	DATE 7-63	ALBERT A. WEBB ASSOCIATES CIVIL ENGINEERS	W.O. 60-115
DRAWN			SHEET 8
TRACED			OF SHEETS
CHECKED		RIVERSIDE CALIFORNIA	DWG. NO.
P.B.		1164	

1164

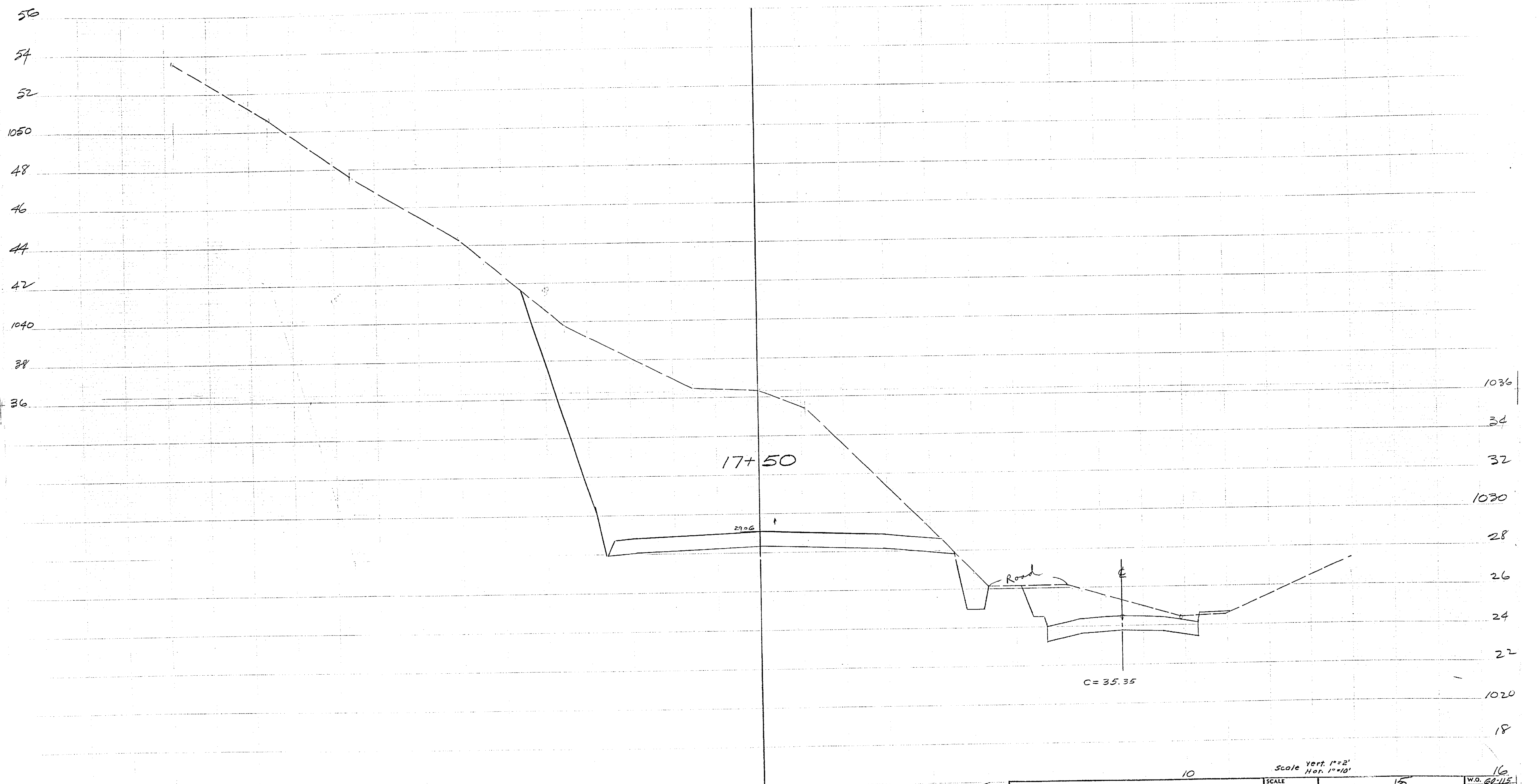

CITY OF RIVERSIDE
 CROSS SECTIONS
 ARLINGTON AVENUE BETWEEN
 VICTORIA AVE & ALESSANDRO BLVD.

Scale Vert. 1"=2'
 Hor. 1"=10'

SCALE	ALBERT A. WEBB ASSOCIATES	W.O. 16
DATE 7-63	CIVIL ENGINEERS	SHEET 7
DRAWN		OF SHEETS
TRACED	RIVERSIDE CALIFORNIA	DWG. NO.
CHECKED		
F.B.		

1164

1164

1164

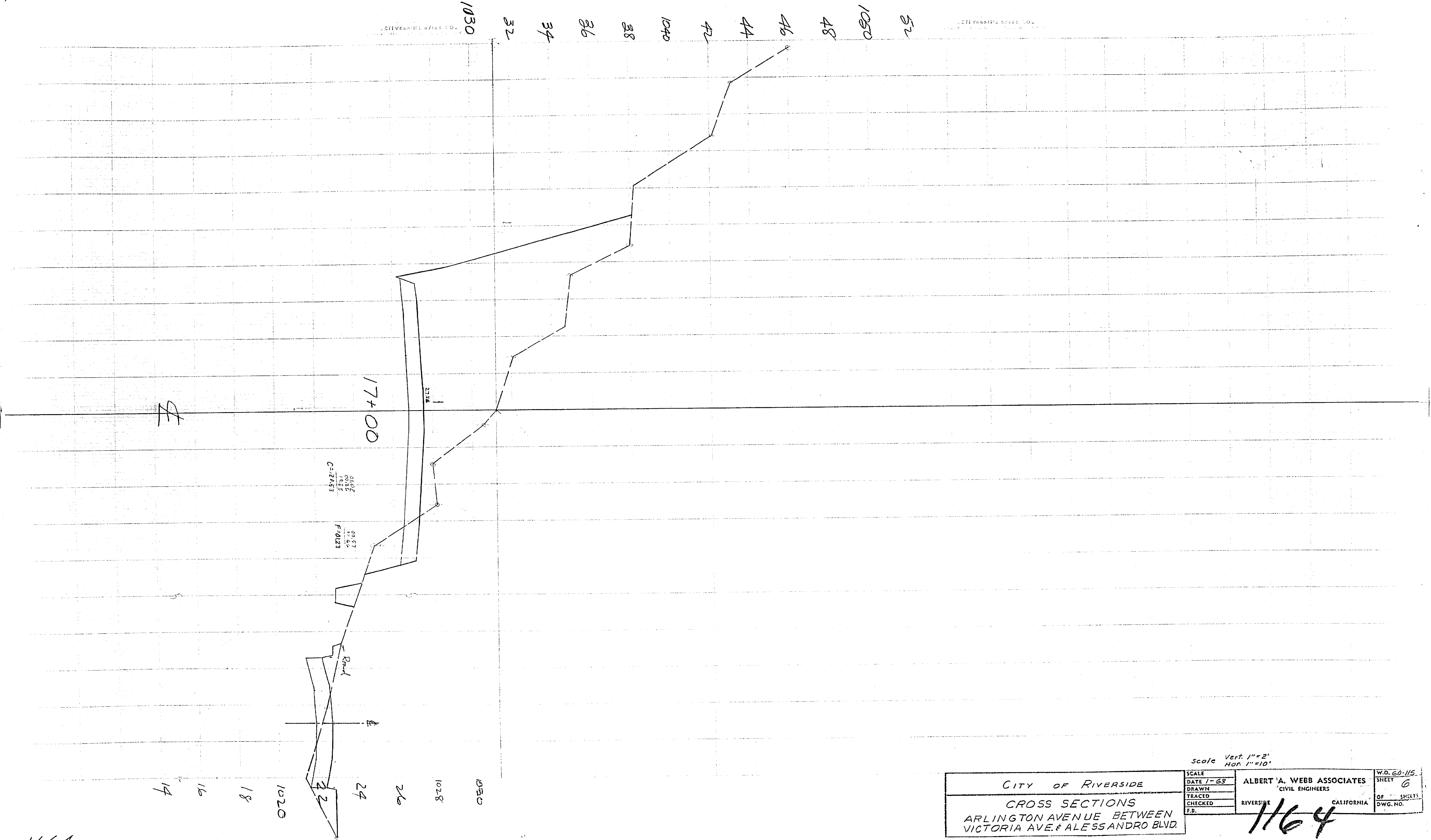

CITY OF RIVERSIDE		ALBERT A. WEBB ASSOCIATES CIVIL ENGINEERS		W.D. 60-115 SHEET 6
CROSS SECTIONS		RIVERSIDE CALIFORNIA		OF SHEETS DWG. NO.
ARLINGTON AVENUE BETWEEN VICTORIA AVE. & ALESSANDRO BLVD.		1164		

Scale Vert 1"=2'
Hor 1"=10'

SCALE	DATE 1-68	W.D. 60-115
DRAWN		SHEET 6
TRACED		OF SHEETS
CHECKED		DWG. NO.
F.B.		

1164

1164

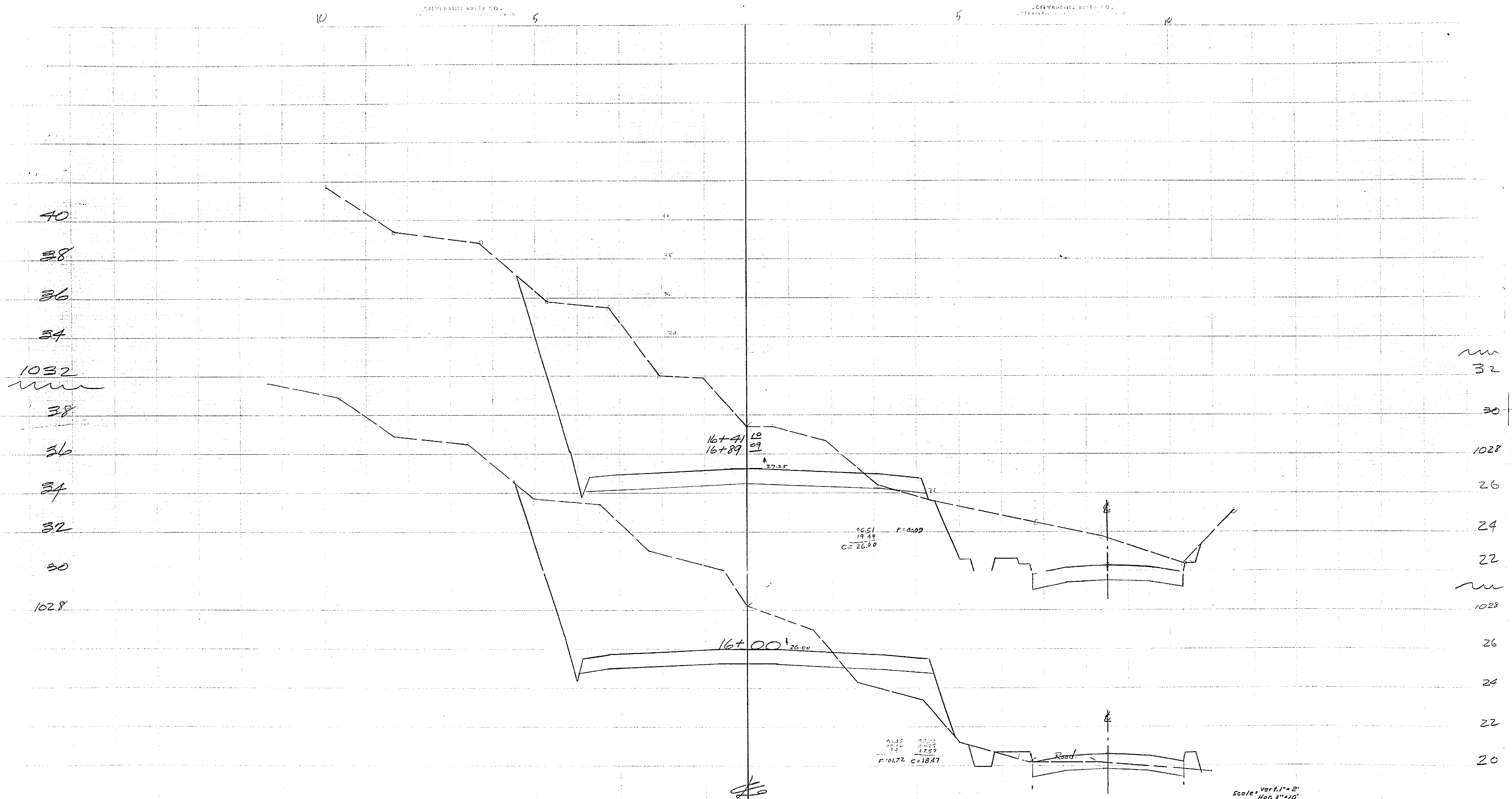

1032

38

36

34

32

30

1028

32

30

1028

26

24

22

1028

26

24

22

20

CITY OF RIVERSIDE		SCALE	W.O. 60-115
CROSS SECTIONS		DATE 1-63	SHEET 5
ARLINGTON AVENUE BETWEEN		DRAWN	OF SHEETS
VICTORIA AVE. & ALESSANDRO BLVD.		TRACED	DWG. NO.
		CHECKED	
		F.B.	

ALBERT A. WEBB ASSOCIATES
CIVIL ENGINEERS
RIVERSIDE CALIFORNIA

1164

1164

11

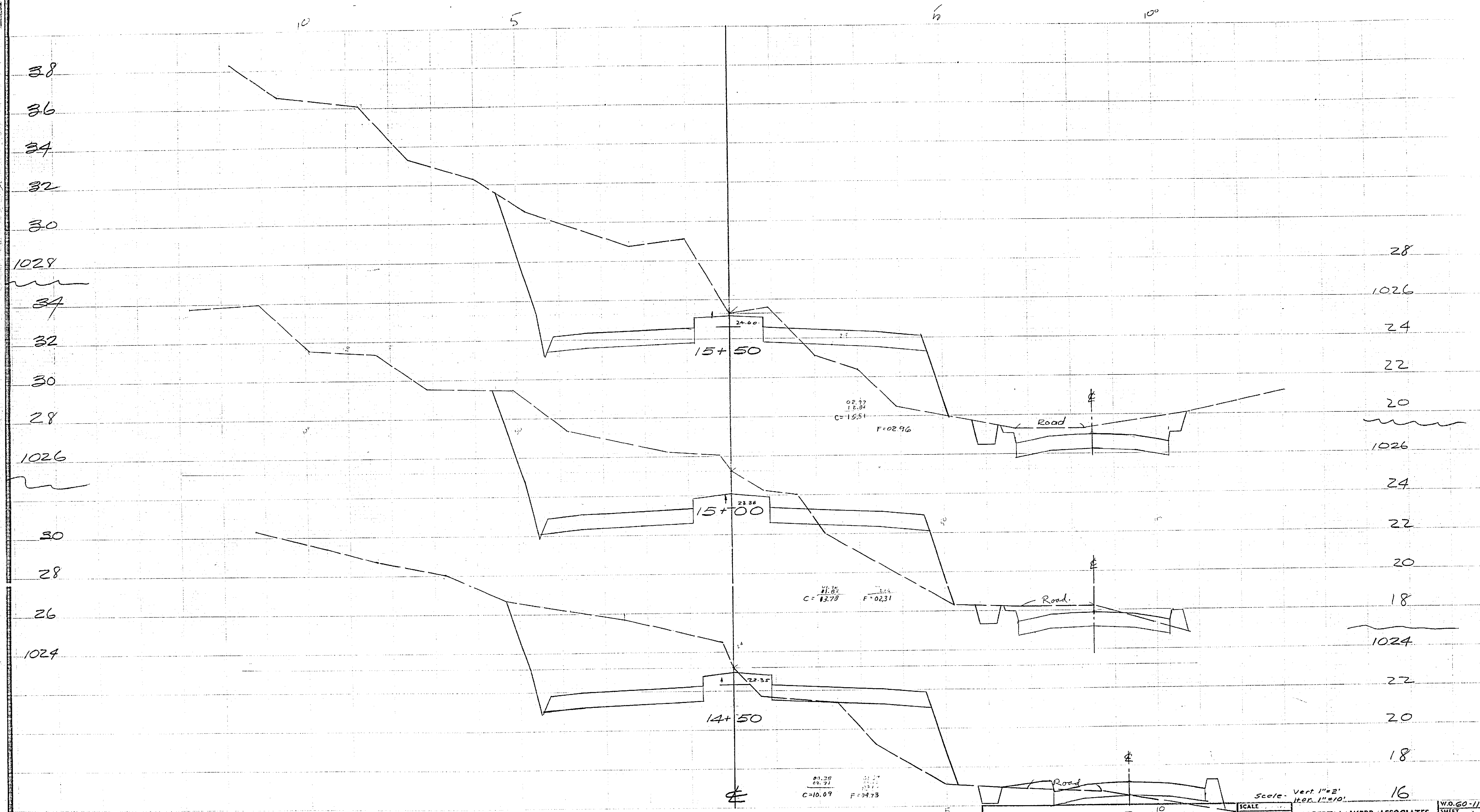

38
36
34
32
30
28
26
24
22
20
18
16

1028
1026
1024

28
24
22
20
18
16

1026
1024

CITY OF RIVERSIDE
 CROSS SECTIONS
 ARLINGTON AVENUE BETWEEN
 VICTORIA AVE. & ALESSANDRO BLVD.

Scale: Vert 1"=2'
 Hor. 1"=10'

SCALE	ALBERT A. WEBB ASSOCIATES	W.O. 60-11
DATE 1-63	CIVIL ENGINEERS	SHEET 4
DRAWN		OF SHEET
TRACED		DWC. NC.
CHECKED		
F.S.		

1169

64

1164

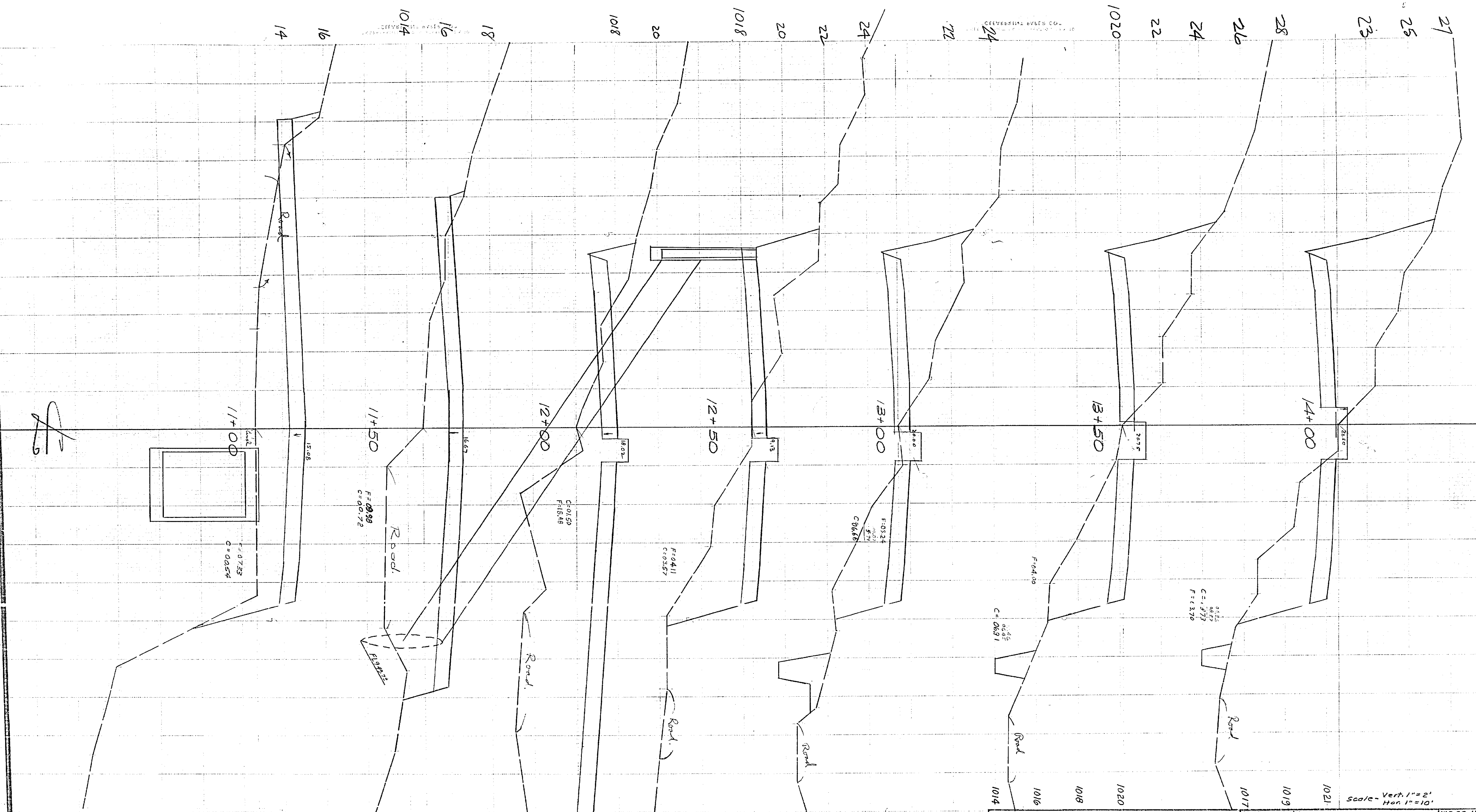

CITY OF RIVERSIDE
 CROSS SECTIONS
 ARLINGTON AVENUE BETWEEN
 VICTORIA AVE. & ALESSANDRO BLVD.

SCALE	DATE	DRAWN	TRACED	CHECKED	F.S.
1"=2'	1-63				
ALBERT A. WEBB ASSOCIATES CIVIL ENGINEERS					W.D. 60-115 SHEET 3
RIVERSIDE CALIFORNIA					OF SHEETS DWG. NO.

1164

1164

1164

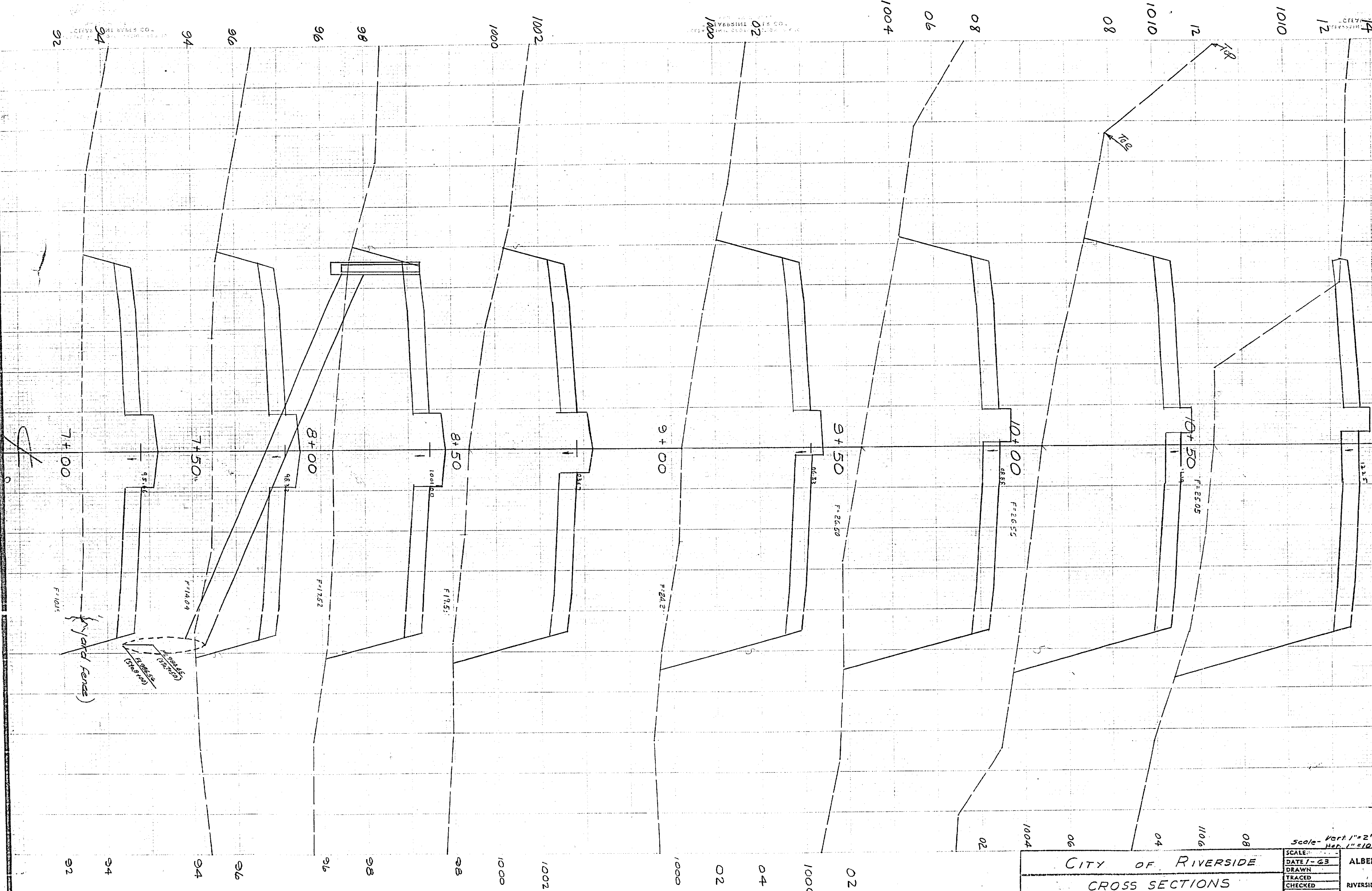

CITY OF RIVERSIDE
 CROSS SECTIONS
 ARLINGTON AVENUE BETWEEN
 VICTORIA AVE & ALESSANDRO BLVD.

SCALE: Vert 1"=2'
 Hor 1"=50'

DATE 7-63
 DRAWN
 TRACED
 CHECKED
 F.B.

ALBERT A. WEBB ASSOCIATES
 CIVIL ENGINEERS
 RIVERSIDE CALIFORNIA

W.O. 60-71
 SHEET 2
 OF SHEETS
 DWG. NO.

1164

1164

1164

1164

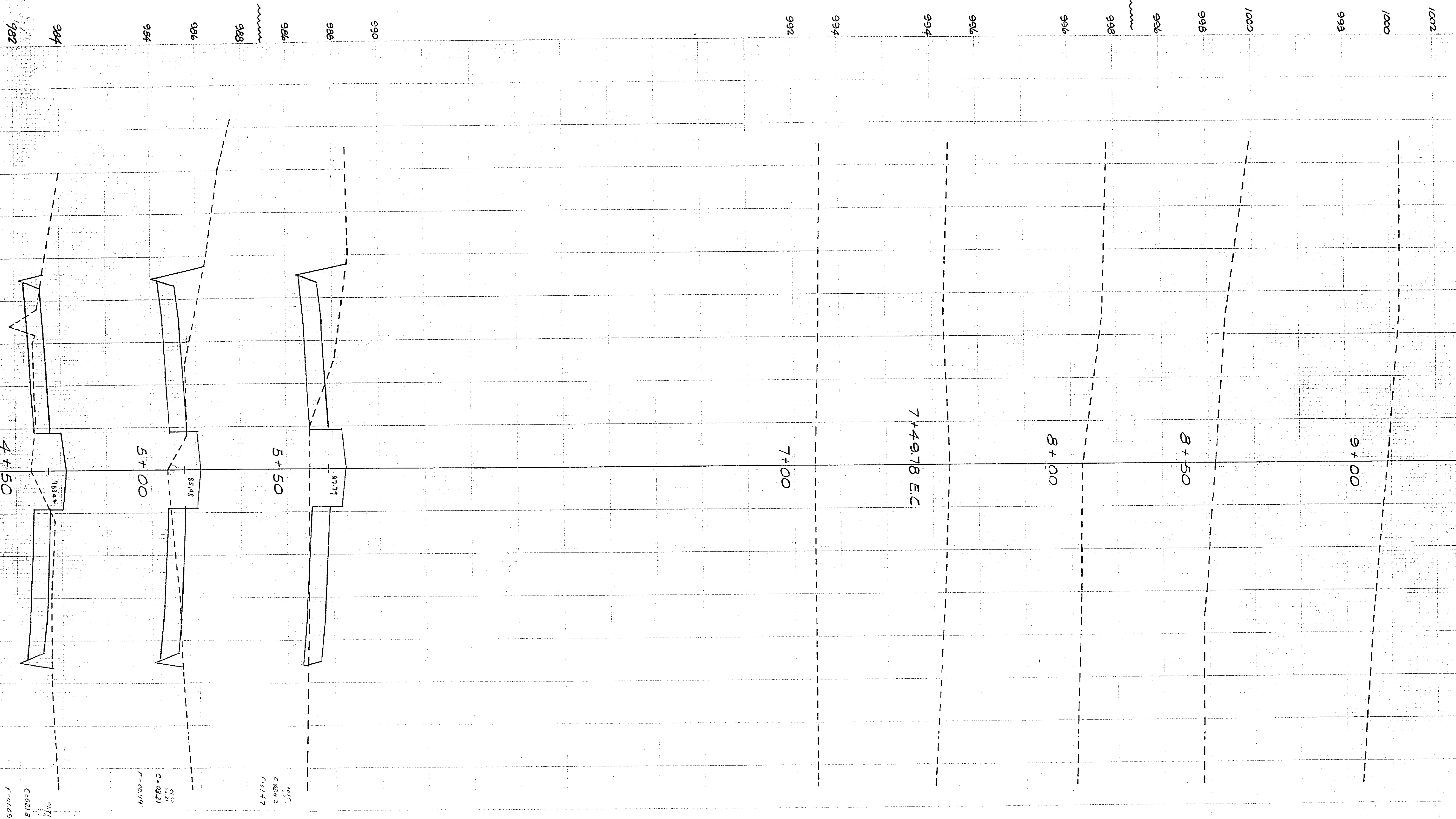

$\frac{1}{2}$ " = 1' V
 C-0218
 F-0160

$\frac{1}{2}$ " = 1' V
 C-0218
 F-0279

$\frac{1}{2}$ " = 1' V
 C-0218
 F-0147

1164

982 984 986 988 990
 982 984 986 988 990

992 994 996 998 1000 1002

SCALE DATE 7-83 DRAWN TRACED CHECKED P.E.		1000 scale Vert. 1"=20' Hor. 1"=40' 998 996 994 992	1000 998 996 994 992	W.D. 60-11 SHEET 1 OF SHEETS DWG. NO.
CITY OF RIVERSIDE CROSS SECTIONS ARLINGTON AVENUE BETWEEN VICTORIA AVE. & ALESSANDRO BLVD.		ALBERT A. WEBB ASSOCIATES CIVIL ENGINEERS RIVERSIDE CALIFORNIA		

1164