

PROPERTY OF
CITY OF RIVERSIDE
CITY ENGINEERS DEPT.

PROPERTY OF
CITY OF RIVERSIDE
CITY ENGINEERS DEPT.

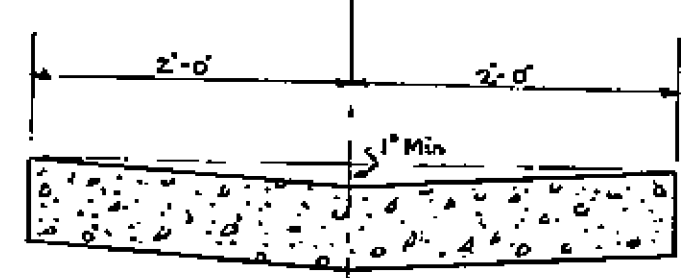

DETAIL OF CROSS GUTTER
Scale 1"=1'

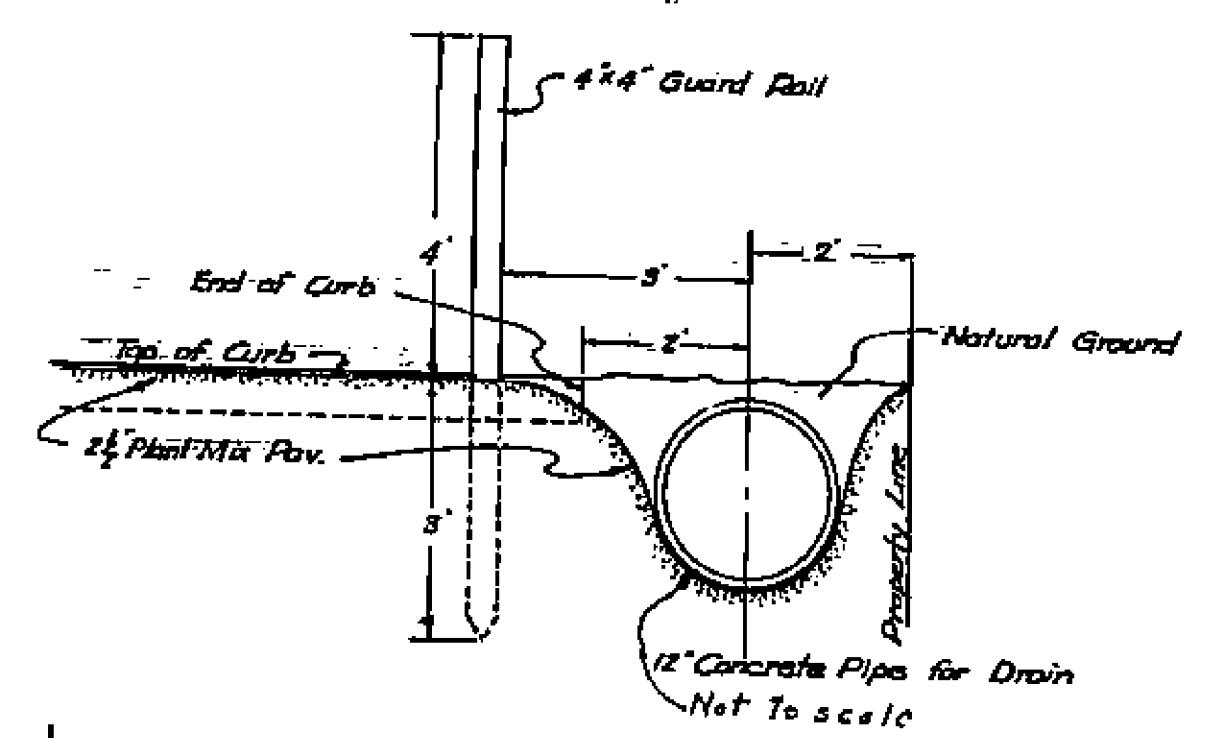
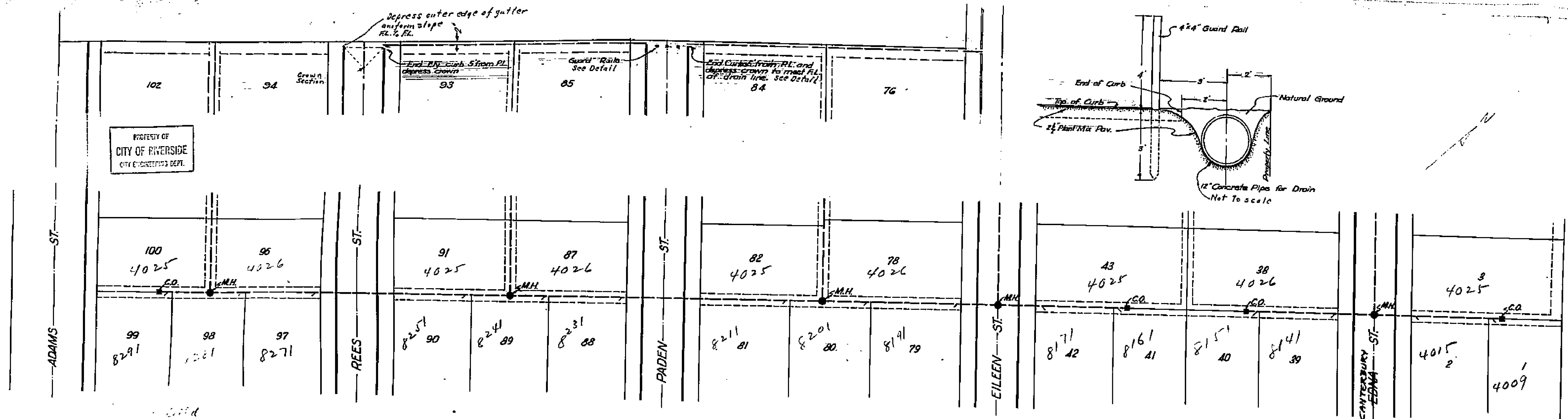
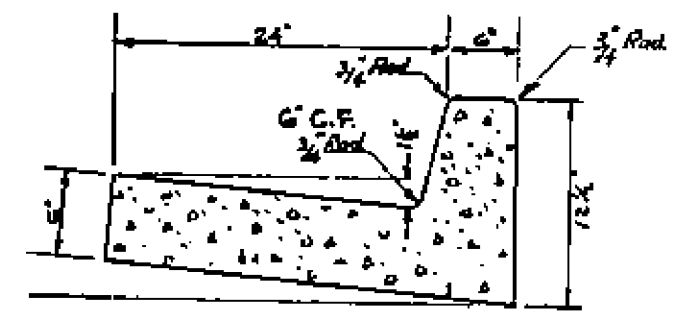

DETAIL OF COMBINATION CURB AND GUTTER
Scale 1"=1'

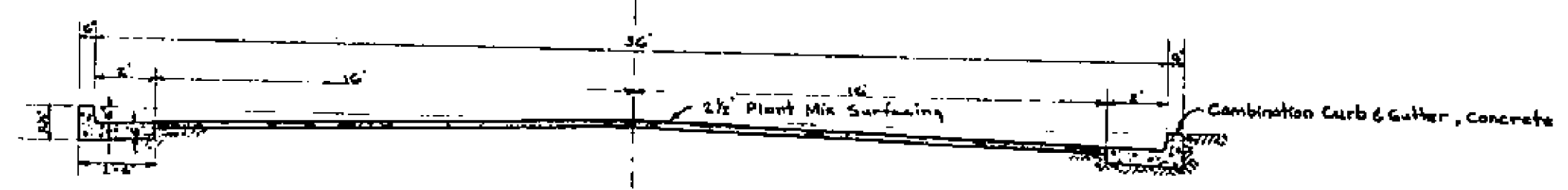

TYPICAL STREET SECTION
Scale 1"=4'

NOTE:
For pavement specifications see City Ordinance
No. 1828, Section 10, Part 5, Paragraph 5

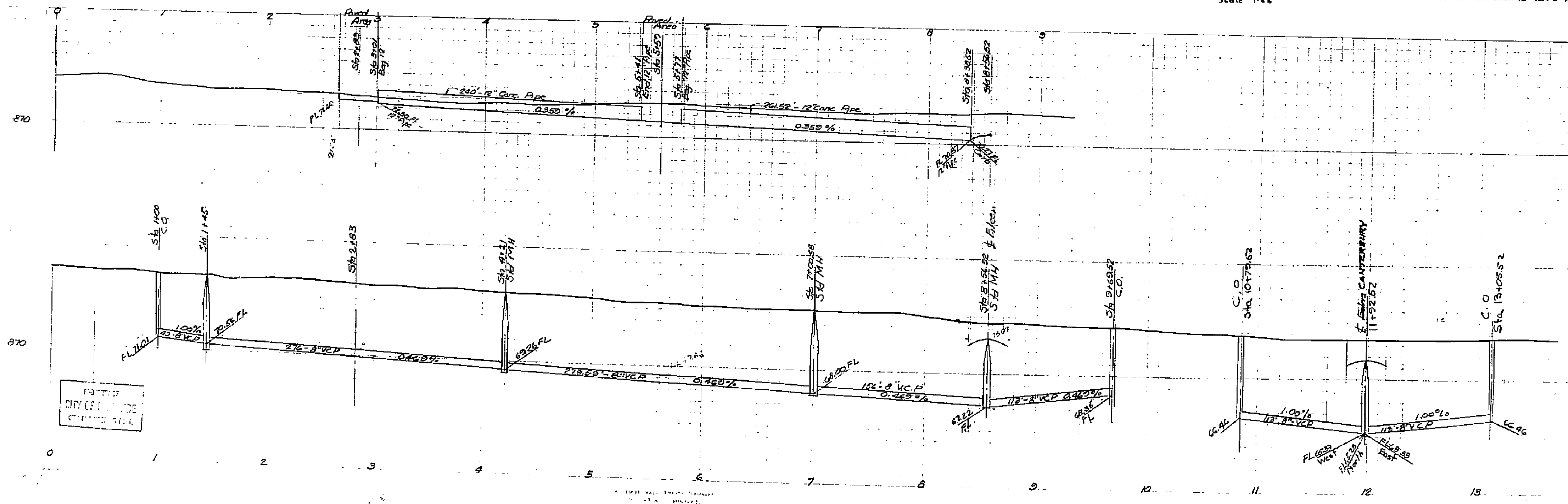

Sheet 6 of 6 Streets
Zak Ranches Tract
J.F. Davidson C.E.
Approved: *M.H. Harris*
City Engineer

PROPERTY OF
CITY OF RIVERSIDE
CITY ENGINEERS DEPT.

PROPERTY OF
CITY OF RIVERSIDE
CITY ENGINEERS DEPT.

1176

PROPERTY OF
CITY OF RIVERSIDE
CITY ENGINEERING DEPT.

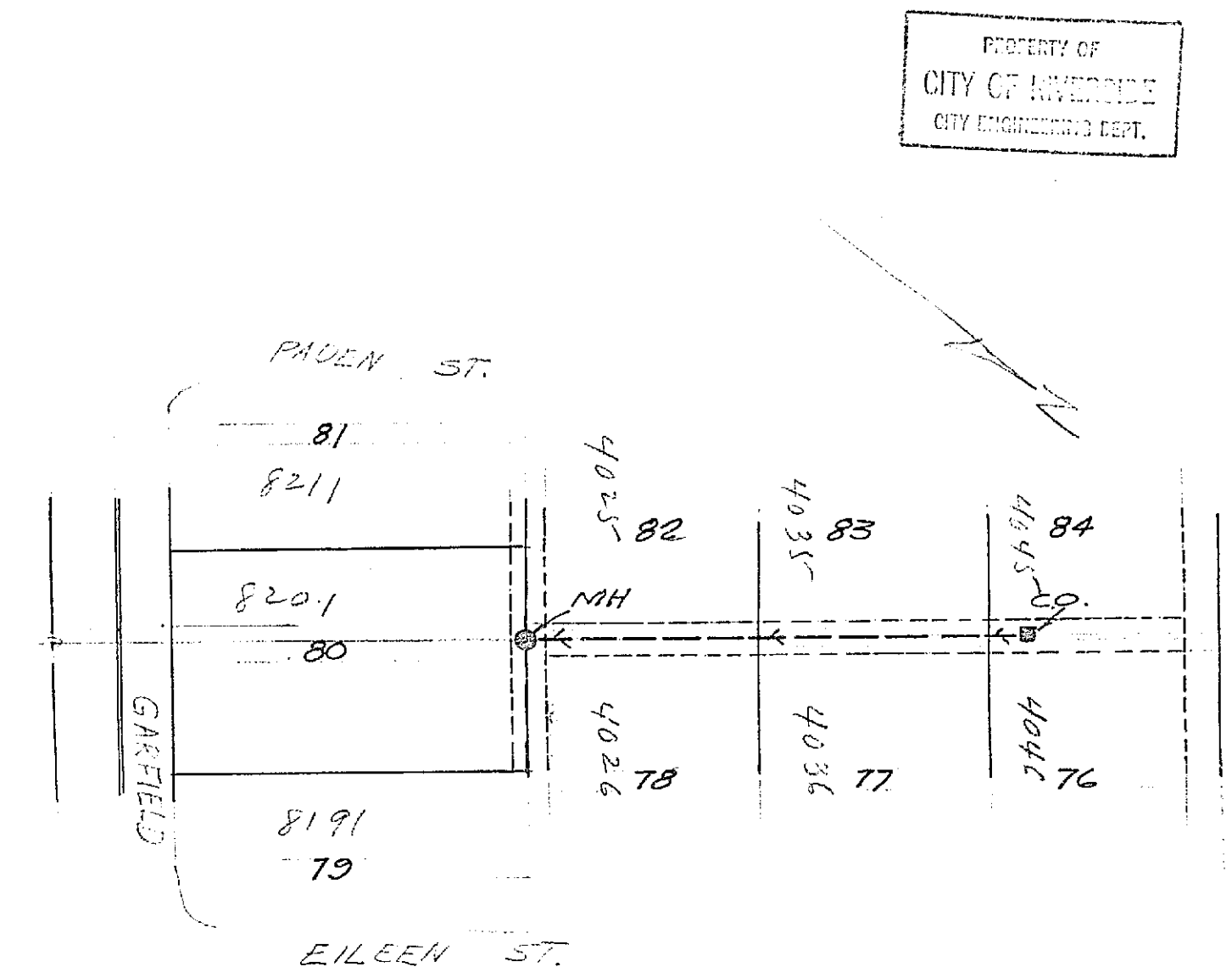
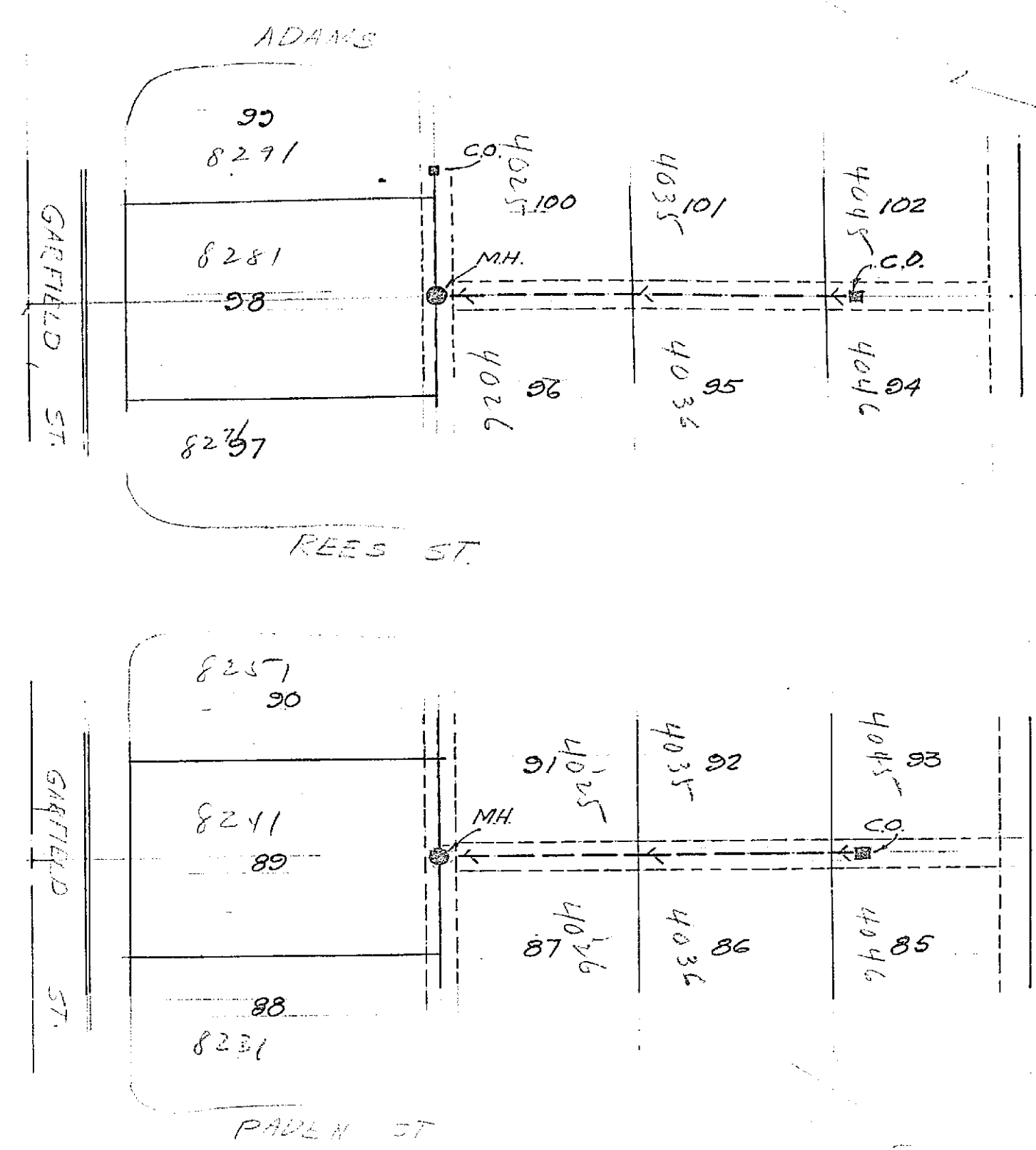
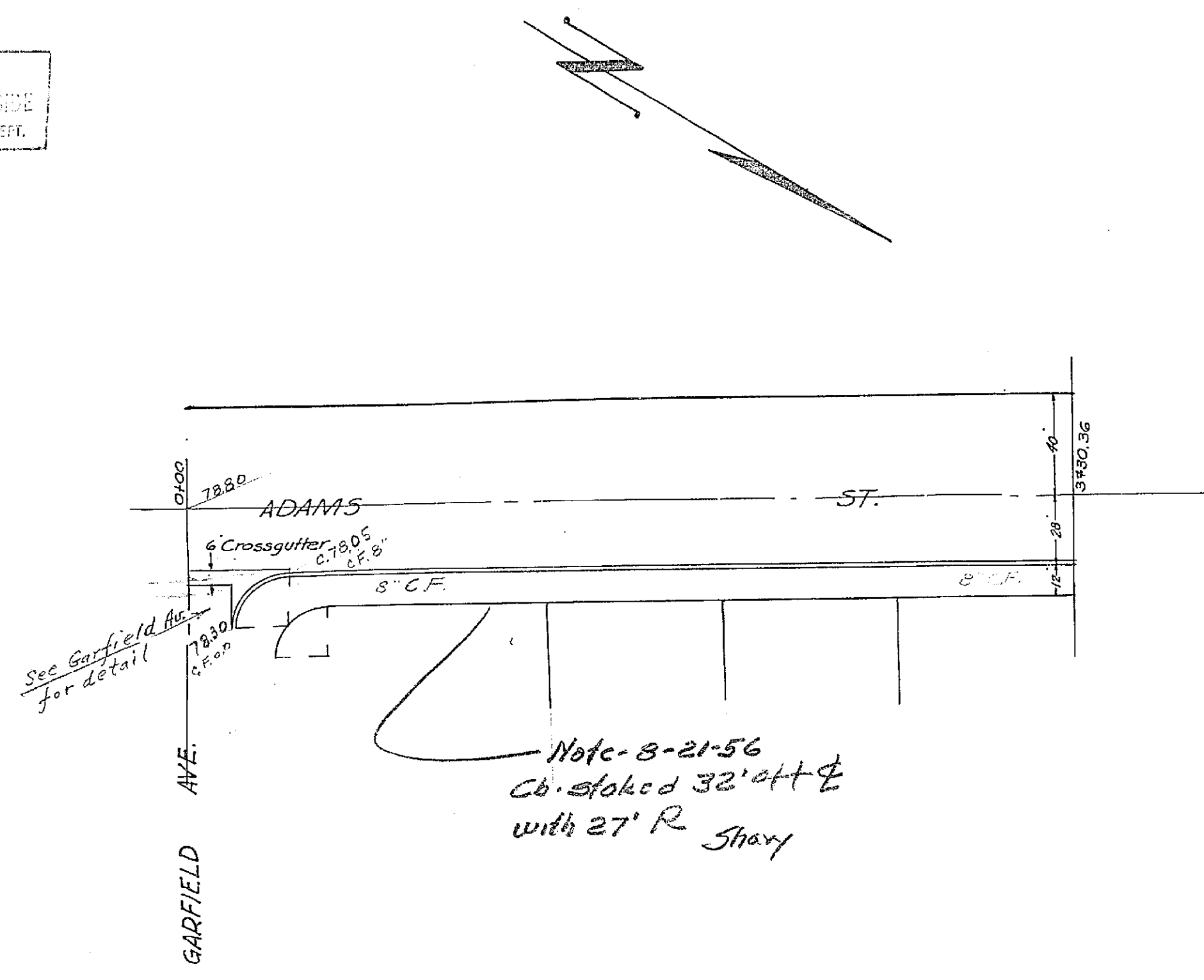

PROPERTY OF
CITY OF RIVERSIDE
CITY ENGINEERING DEPT.

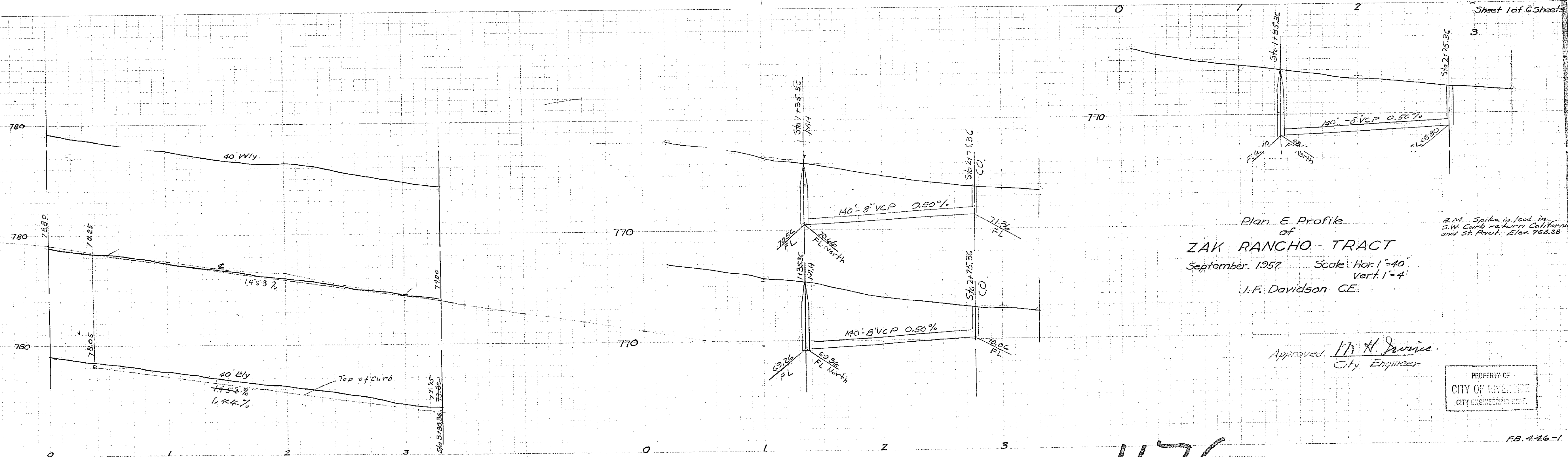

PROPERTY OF
CITY OF RIVERSIDE
CITY ENGINEERING DEPT.

PROPERTY OF
CITY OF RIVERSIDE
CITY ENGINEERING DEPT.

1176

RB. 446-1

PROPERTY OF
CITY OF RIVERSIDE
CITY ENGINEERING DEPT.

PROPERTY OF
CITY OF RIVERSIDE
CITY ENGINEERING DEPT.

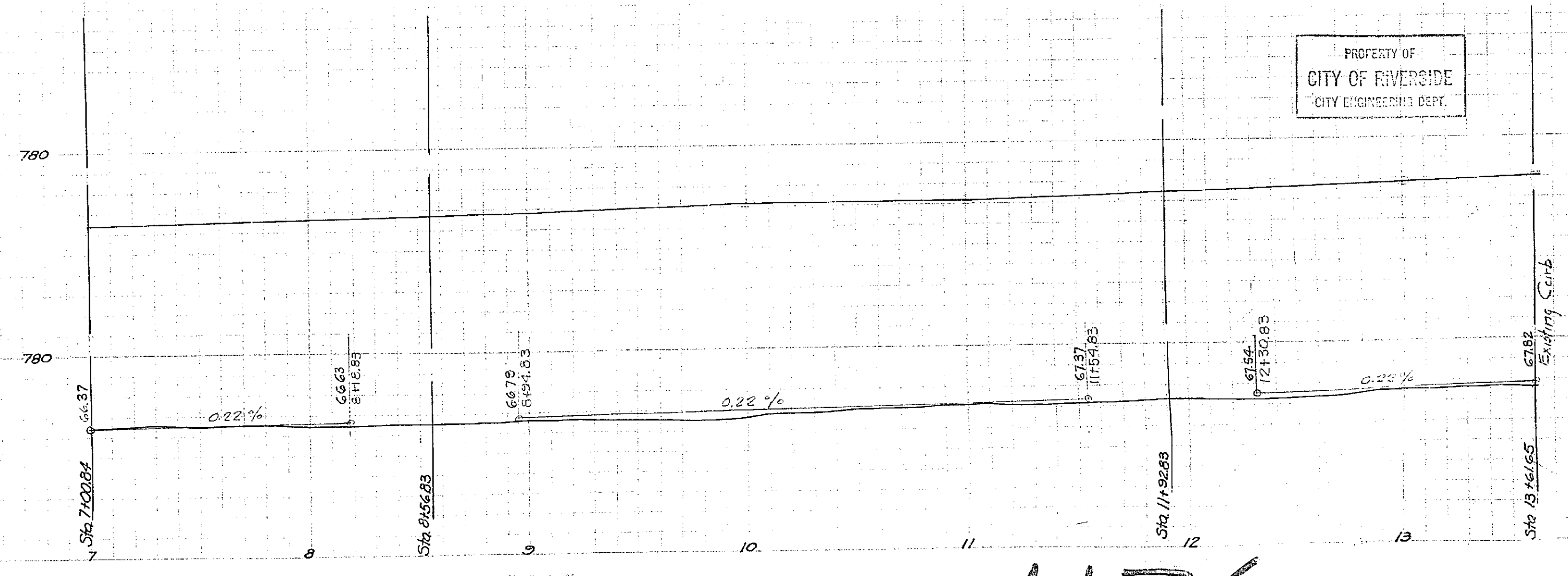
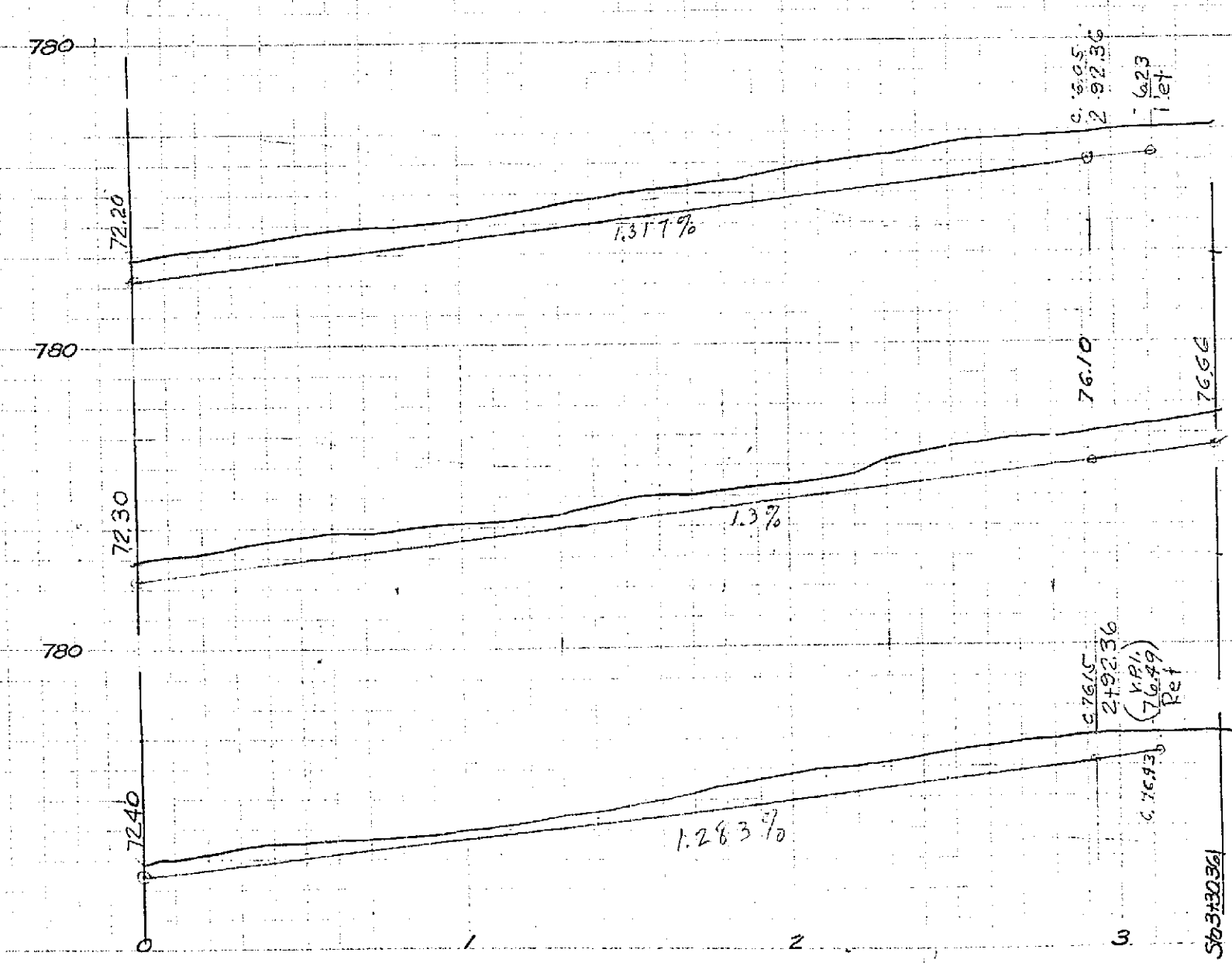
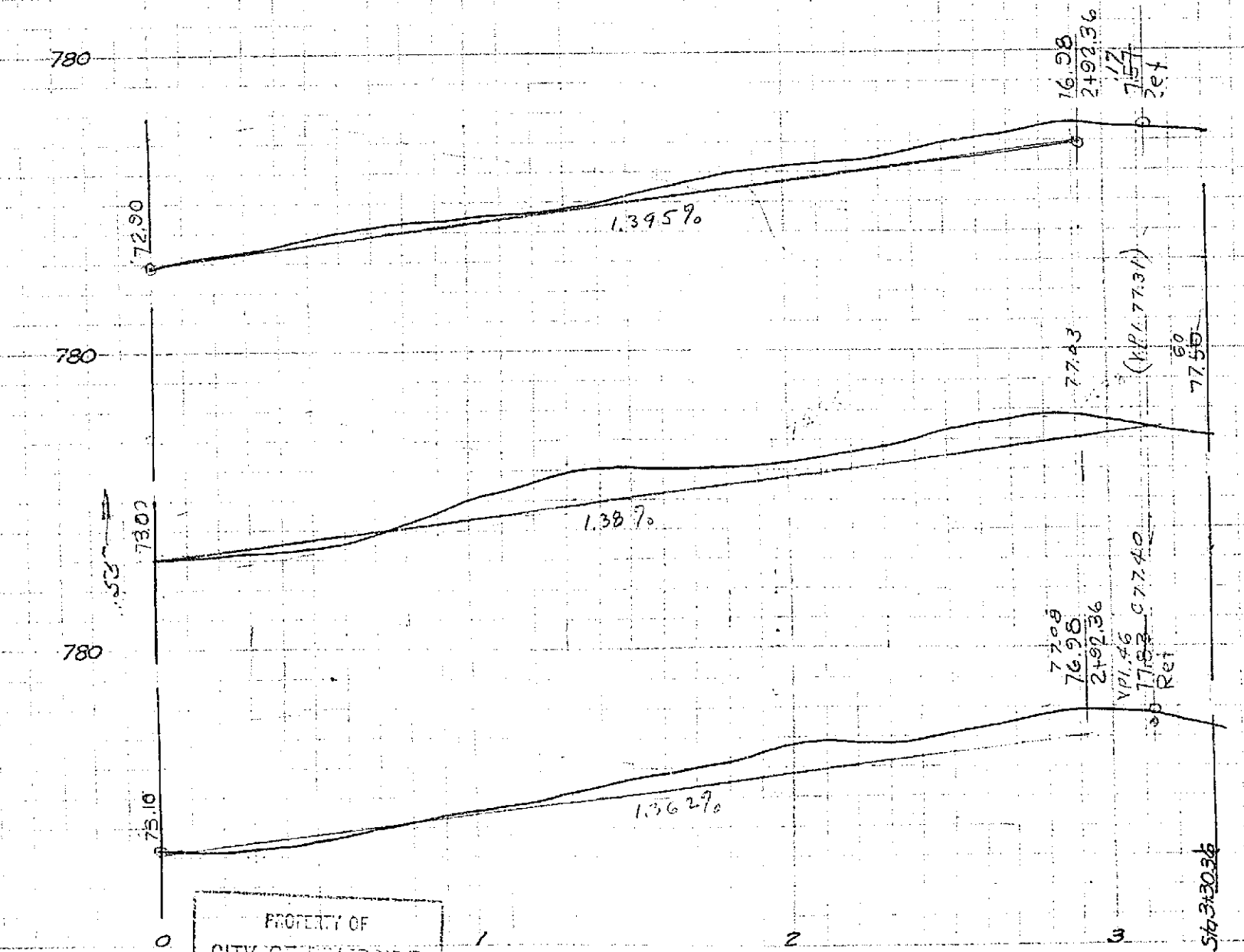
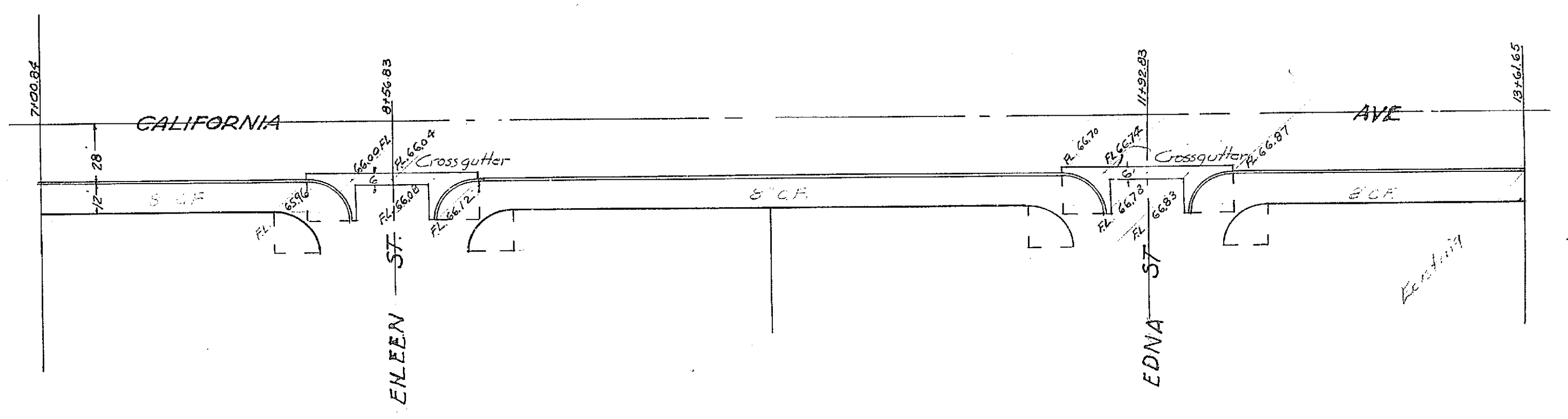
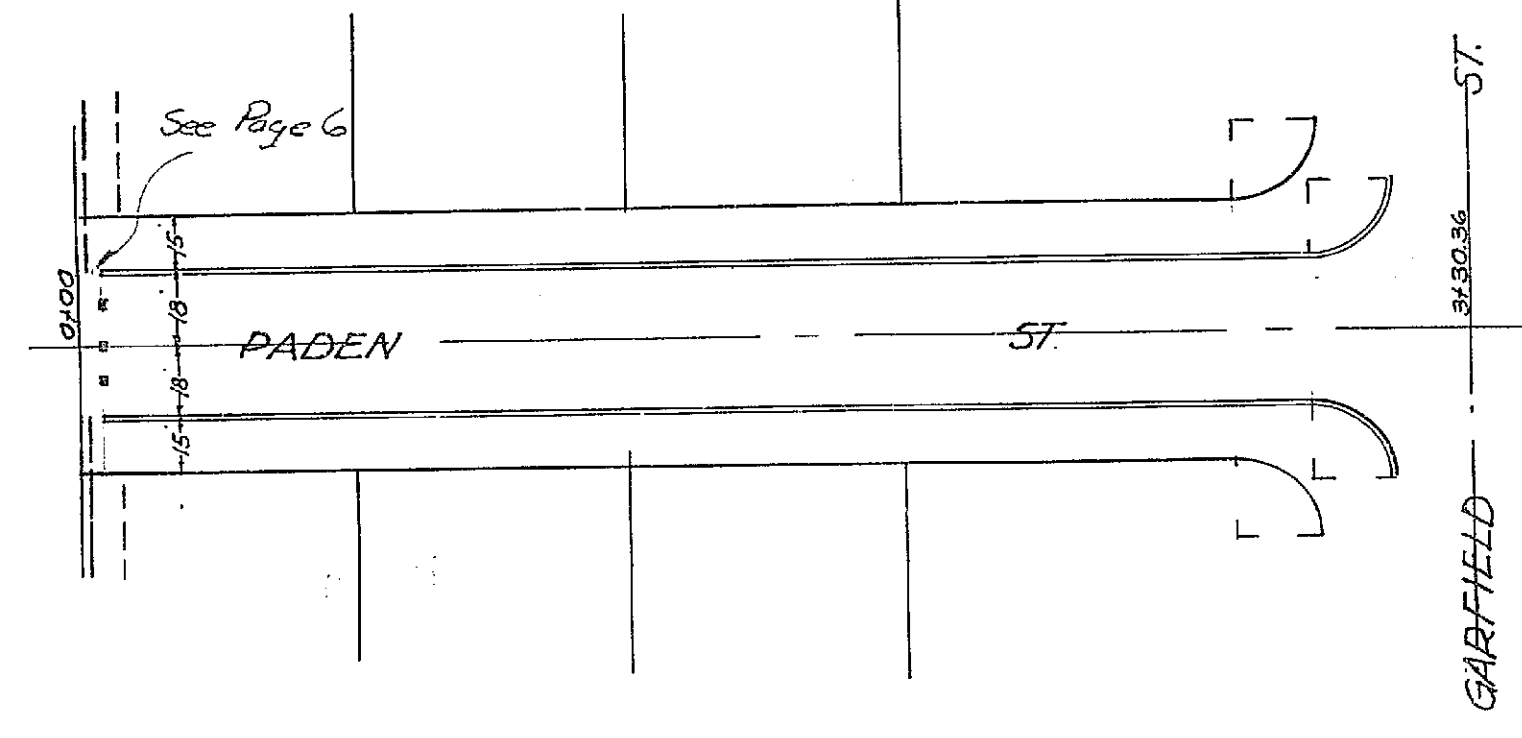
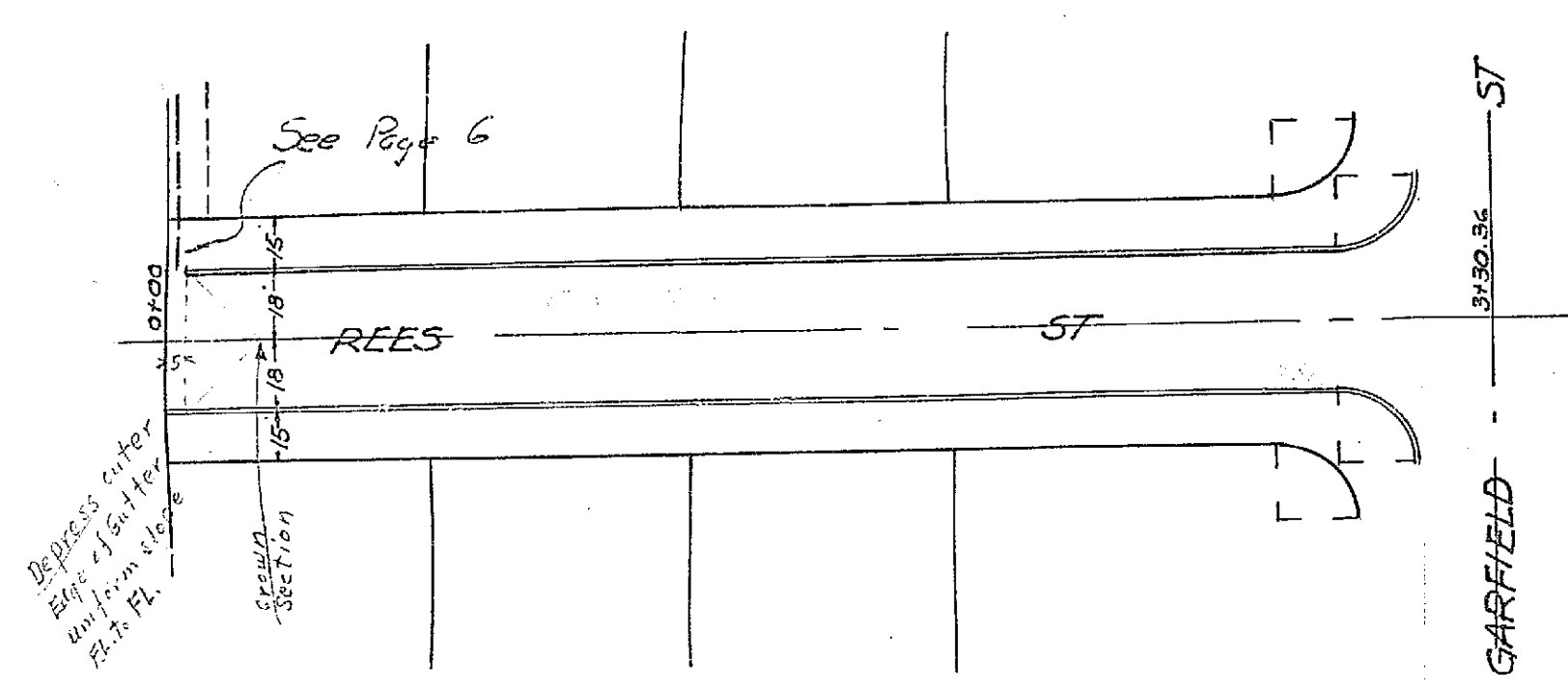

PROPERTY OF
CITY OF RIVERSIDE
CITY ENGINEERING DEPT.

PROPERTY OF
CITY OF RIVERSIDE
CITY ENGINEERING DEPT.

Sheet 4 of 6 Sheets
Zak Ranchos Tract
J.F. Davidson C.E.

Approved: *M.H. Dunning*
City Engineer

1176

S.A.K. 11/15/10

PROPERTY OF
CITY OF RIVERSIDE
CITY ENGINEERING DEPT.

PROPERTY OF
CITY OF RIVERSIDE
CITY ENGINEERING DEPT.

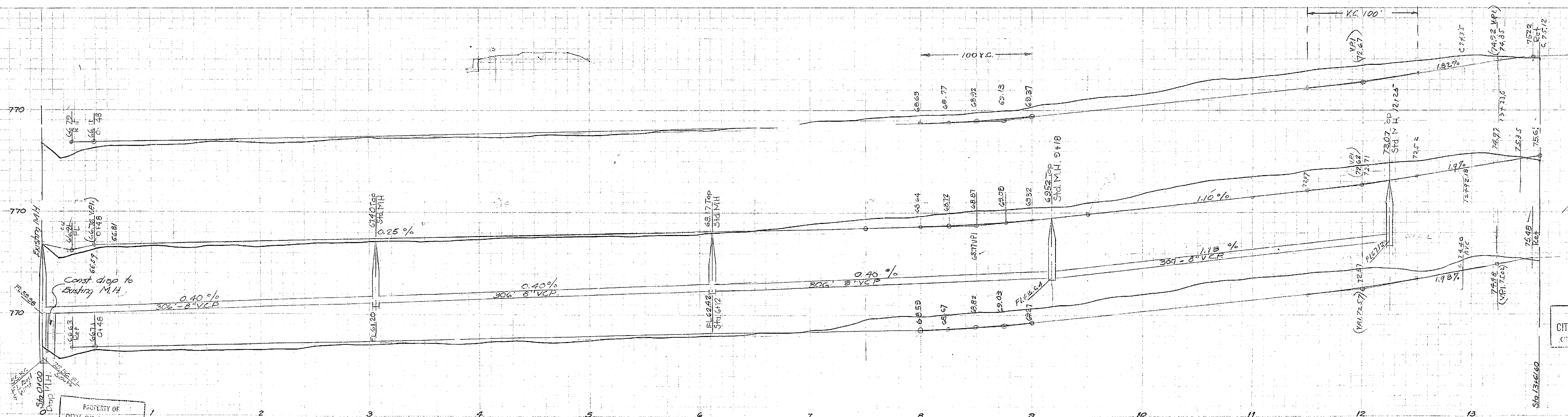
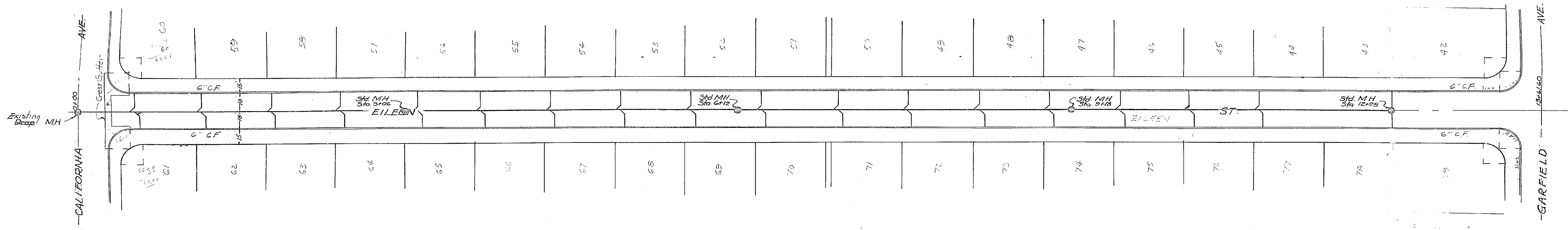

Sheet 3 of 6 Sheet
Zak Ranchos Tract
J.F. Davidson

Approved M.H. Davis
City Engineer

PROPERTY OF
CITY OF RIVERSIDE
CITY ENGINEERING DEPT.

1176

PROPERTY OF
CITY OF RIVERSIDE
CITY ENGINEERING DEPT.

PROPERTY OF
CITY OF RIVERSIDE
CITY ENGINEERING DEPT.

PROPERTY OF
CITY OF RIVERSIDE
CITY ENGINEERING DEPT.

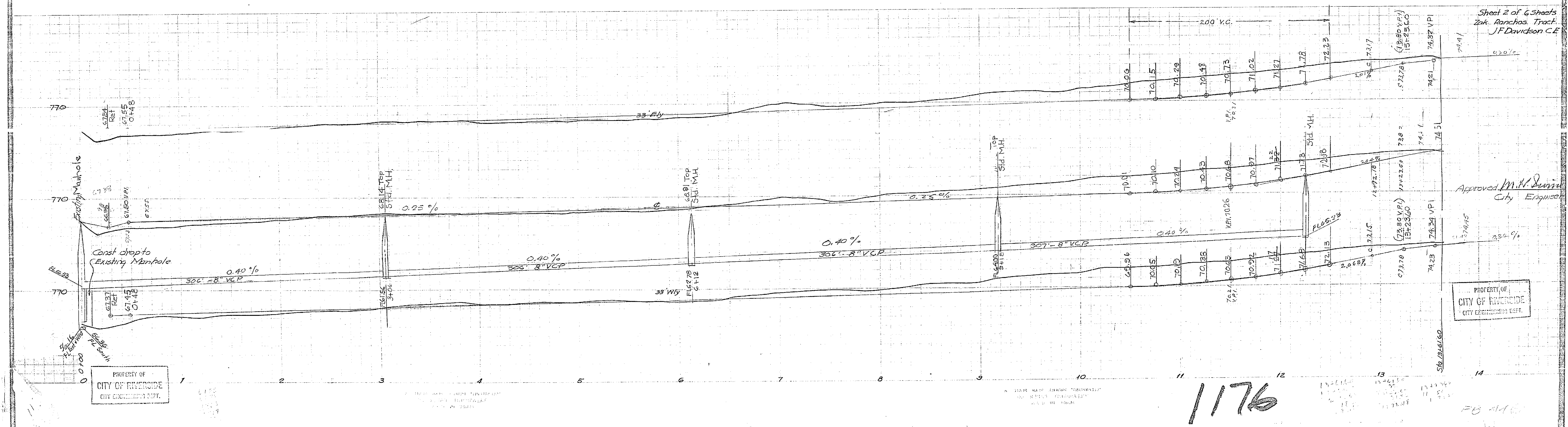
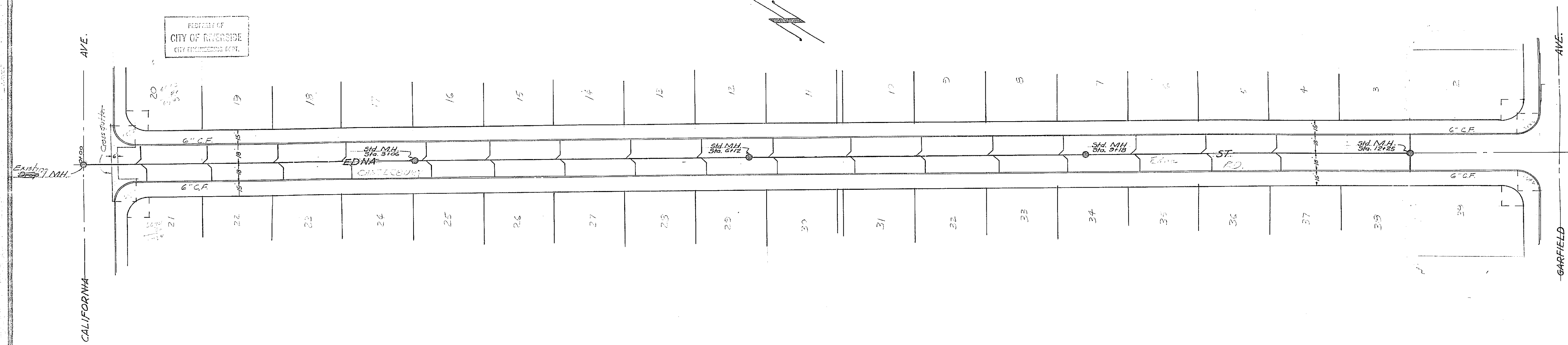
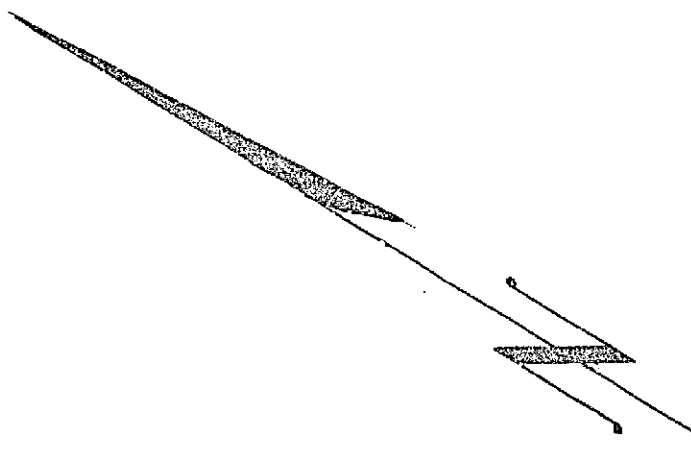

Sheet 2 of 6 Sheets
Zak Ranchos Tract
J.F. Davidson C.E.

Approved M.H. Dunne
City Engineer

1176

FB AM

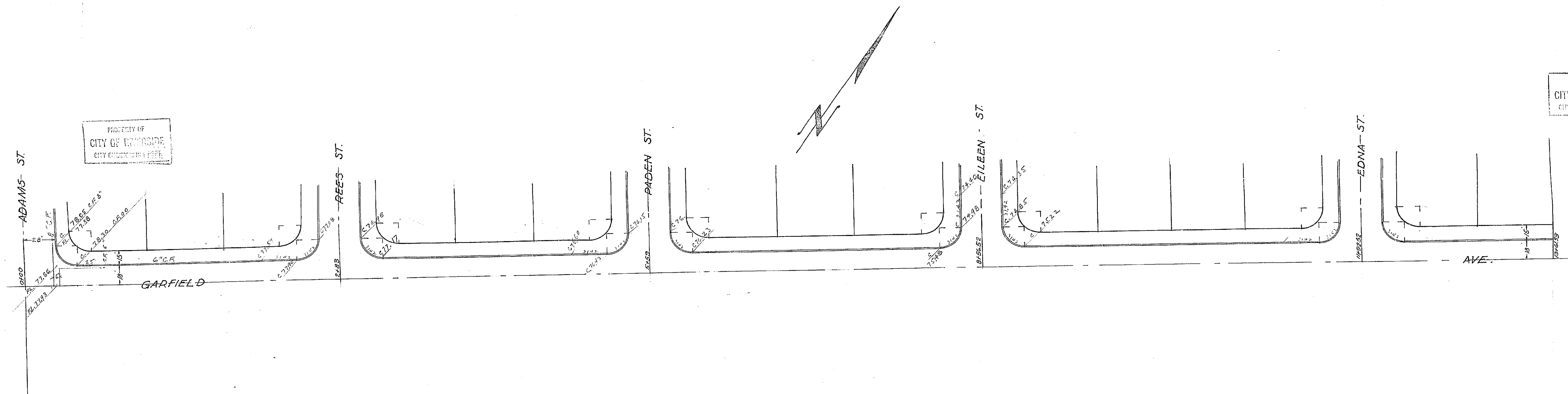

PROPERTY OF
CITY OF RIVERSIDE
CITY ENGINEERING DEPT.

PROPERTY OF
CITY OF RIVERSIDE
CITY ENGINEERING DEPT.

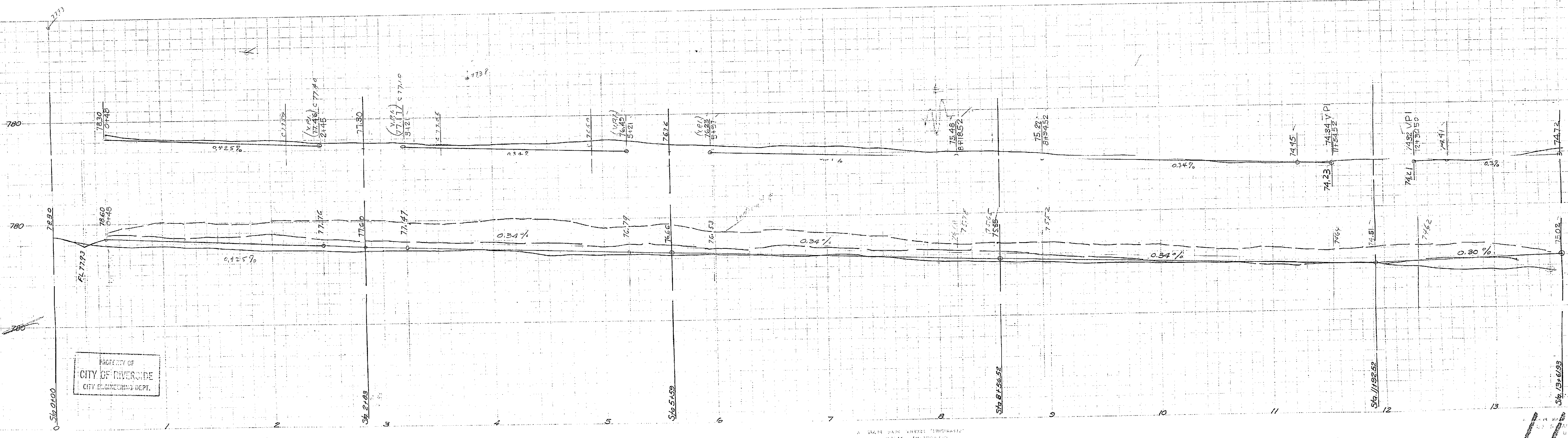

PROPERTY OF
CITY OF RIVERSIDE
CITY ENGINEERING DEPT.

PROPERTY OF
CITY OF RIVERSIDE
CITY ENGINEERING DEPT.

Sheet 5 of 6, Street
Zak Ranchos Tract
J.F. Davidson C.E.

Approved *M. H. Durr*
City Engineer

1176