

PROPERTY OF  
CITY OF RIVERSIDE  
CITY ENGINEERING DEPT.

PROPERTY OF  
CITY OF RIVERSIDE  
CITY ENGINEERING DEPT.

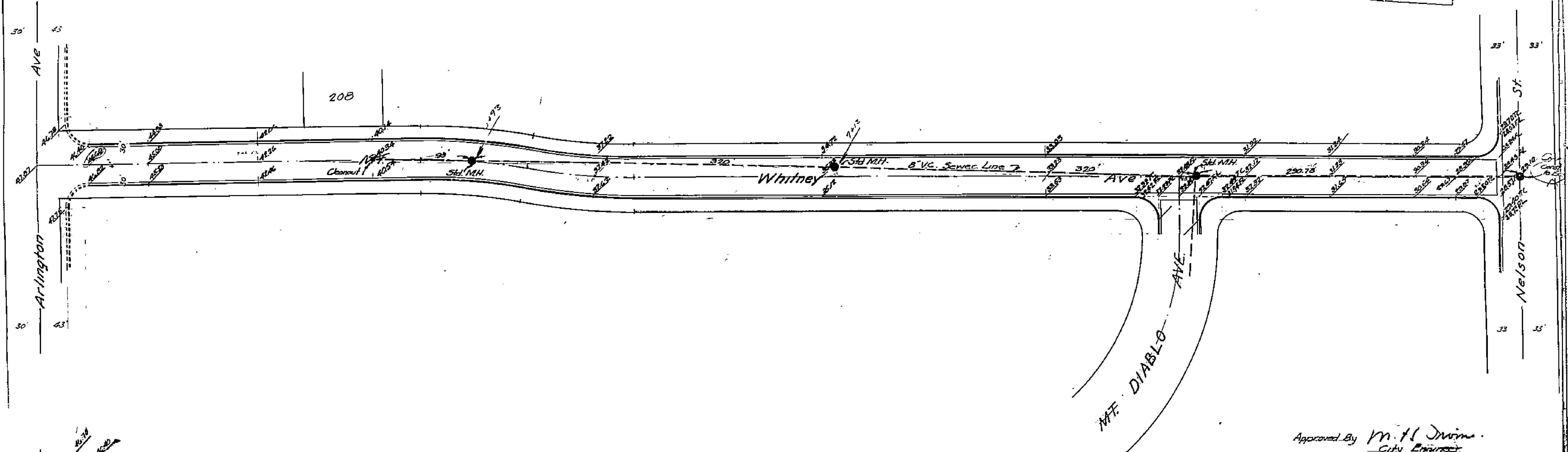

Approved By M. H. Irvine  
City Engineer

PLAN & PROFILE No. 1303  
MT. WHITNEY AVE  
SUN GOLD TERRACE UNIT No. 4  
July 1931 J. F. Davidson, C.E.  
Scale Hor. 1" = 40'  
Vert. 1" = 4'

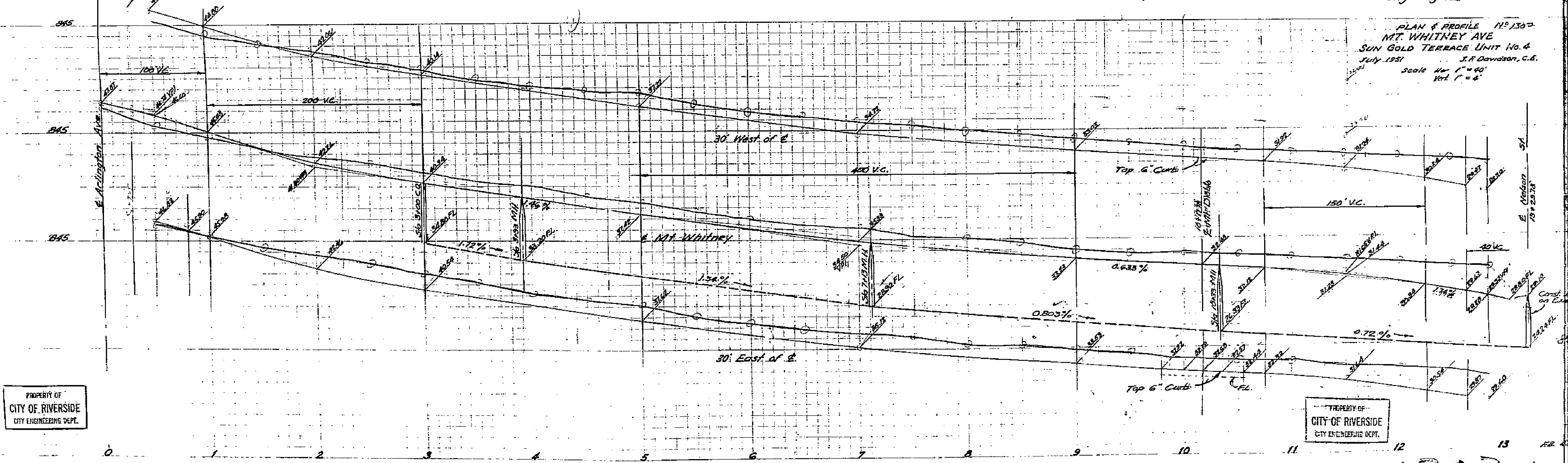

PROPERTY OF  
CITY OF RIVERSIDE  
CITY ENGINEERING DEPT.

PROPERTY OF  
CITY OF RIVERSIDE  
CITY ENGINEERING DEPT.

1303

MADE IN U.S.A.

MADE IN U.S.A.

PROPERTY OF  
CITY OF RIVERSIDE  
CITY ENGINEERING DEPT.

PROPERTY OF  
CITY OF RIVERSIDE  
CITY ENGINEERING DEPT.

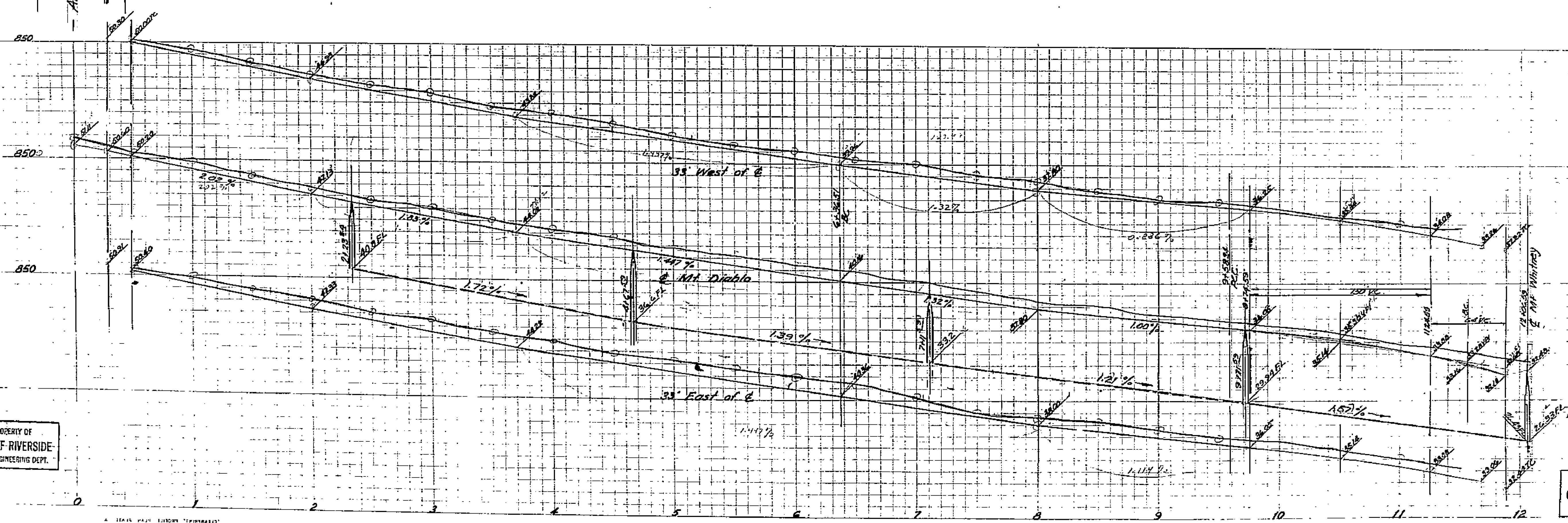
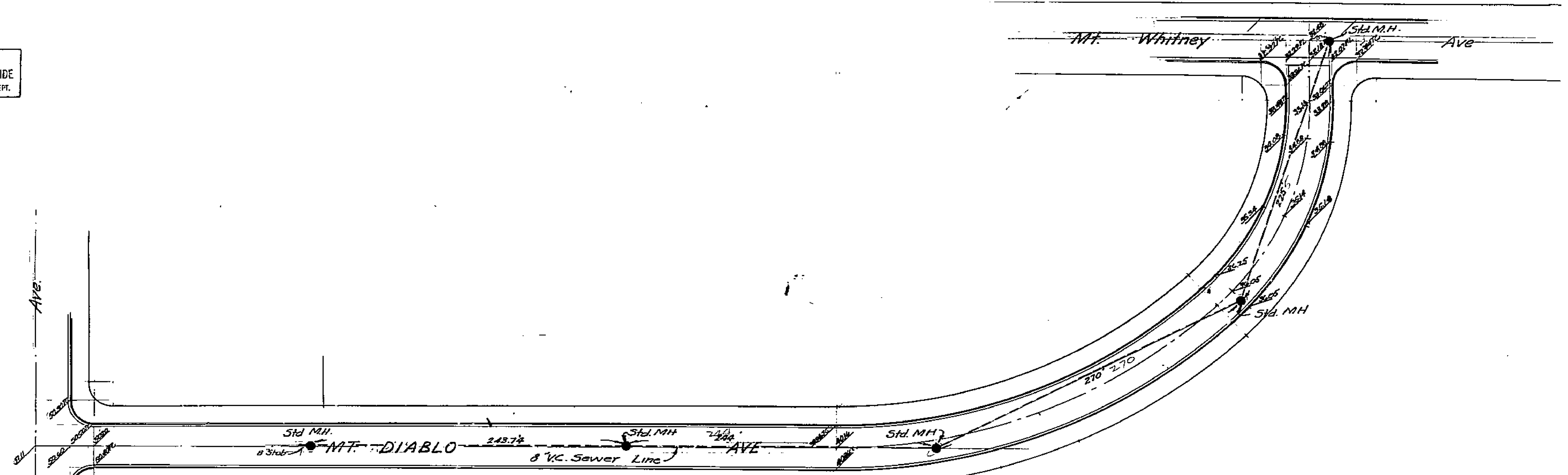

Approved *M. H. Irvine*  
City Engineer

No. 1303-A  
PLAN & PROFILE  
MT. DIABLO AVE  
Sun Gold Terrace Unit No. 4  
July 1951  
J. E. Davidson, C.E.  
Scale - Hor. 1"=40'  
Vert. 1"=8'

PROPERTY OF  
CITY OF RIVERSIDE  
CITY ENGINEERING DEPT.

PROPERTY OF  
CITY OF RIVERSIDE  
CITY ENGINEERING DEPT.

1303

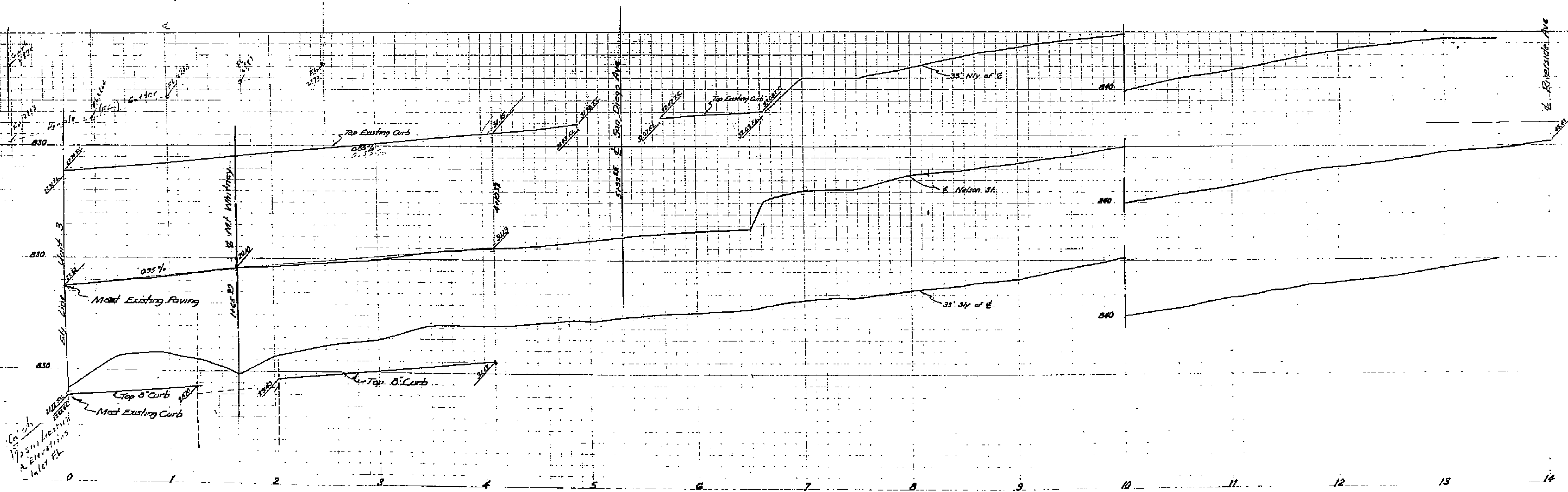
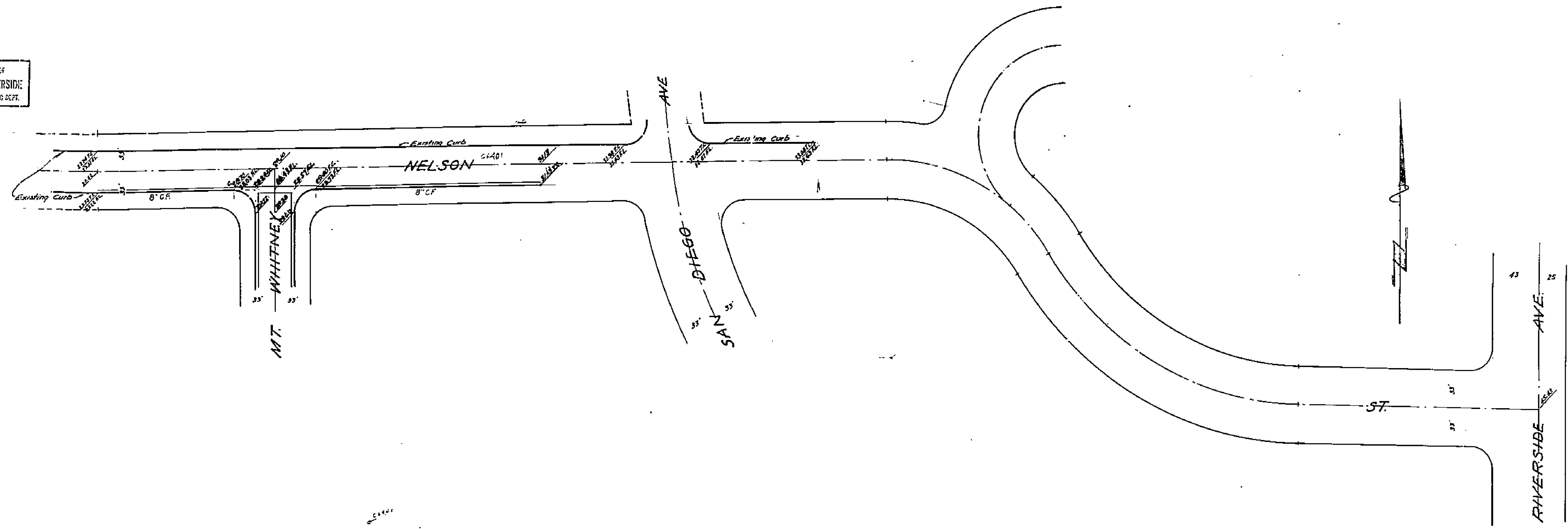

Approved *M. H. Swaine*  
City Engineer

PLAN & PROFILE  
NELSON STREET N2130-  
SUN GOLD TERRACE UNITS 4 & 5  
August 1951 J.R. Davidson, C.E.

Scale Hor. 1"=40'  
Vert. 1"=6'

FD-450-0

1303

PROPERTY OF  
CITY OF RIVERSIDE  
CITY ENGINEERING DEPT.

PROPERTY OF  
CITY OF RIVERSIDE  
CITY ENGINEERING DEPT.

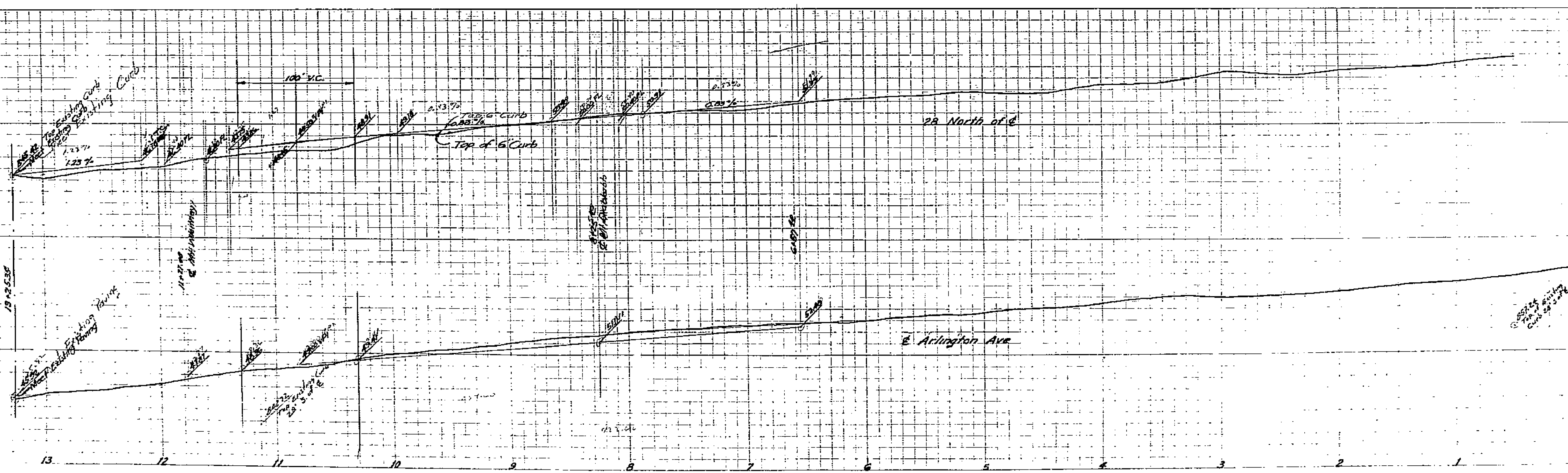
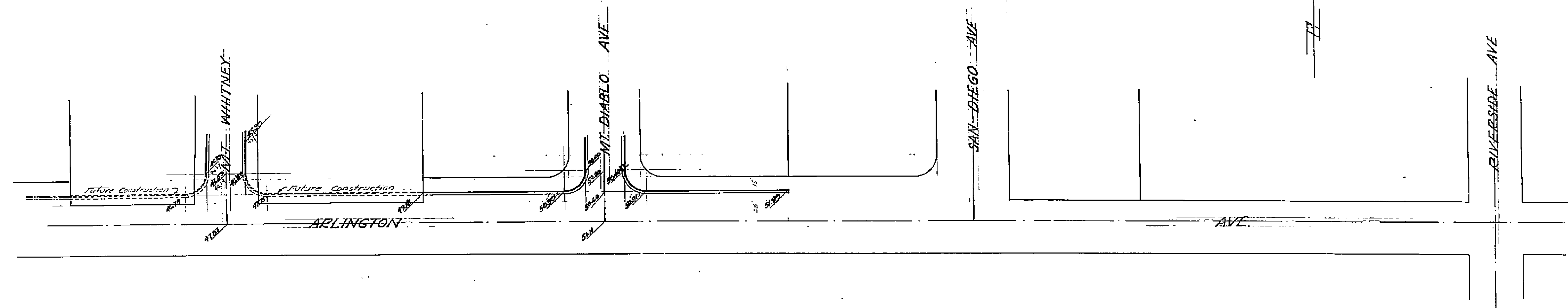

PROPERTY OF  
CITY OF RIVERSIDE  
CITY ENGINEERING DEPT.

Approved M. H. ...  
City Engineer

No 1303  
PLAN & PROFILE  
ARLINGTON AVE  
SUN. GOLD TERRACE UNITS A & B  
July 1951 J.F. Davidson, C.E.  
Scale Hor. 1"=40'  
Vert. 1"=4'

PROPERTY OF  
CITY OF RIVERSIDE  
CITY ENGINEERING DEPT.

1303