

Sheet 2 of 3 Sheets

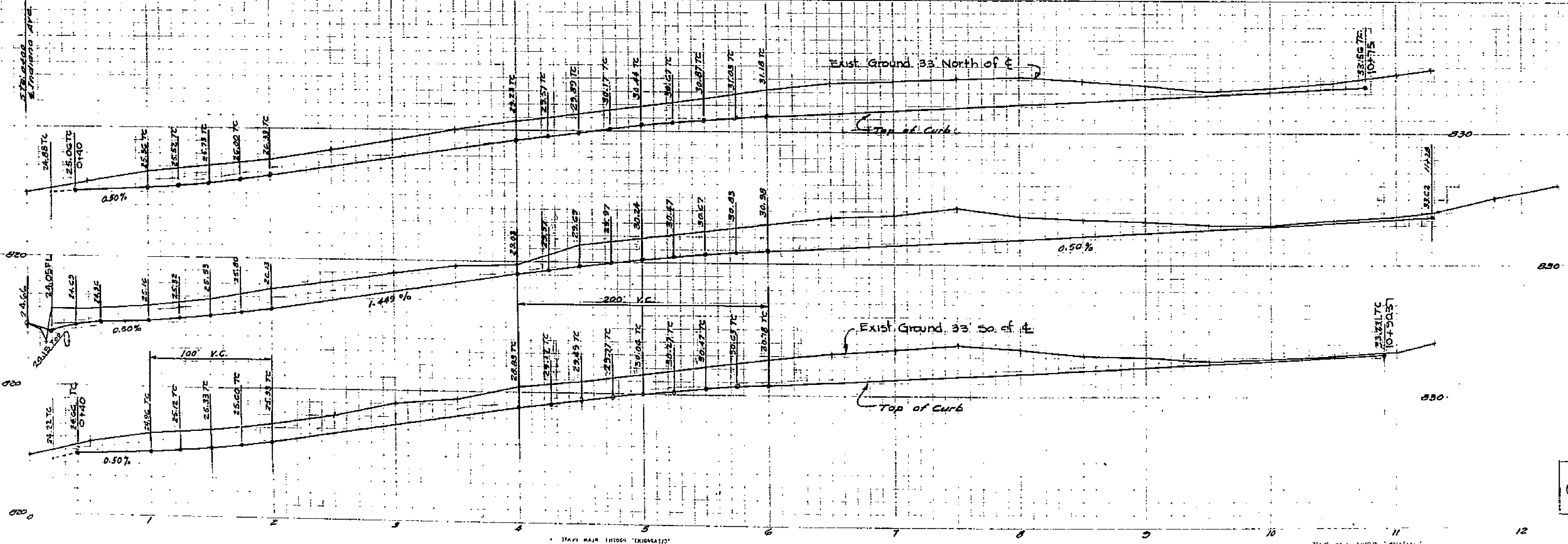

Approved by *M. H. Irvine*
City Engineer

PLAN & PROFILE
VANCE ST.
HARMONY-DALE TRACT
JANUARY 1954 J.F. DAVIDSON, C.E.

SCALE:
HOR. 1"=40'
VERT. 1"=4'

PROPERTY OF
CITY OF RIVERSIDE
ENGINEER: J.C.P.

PROPERTY OF
CITY OF RIVERSIDE
ENGINEER

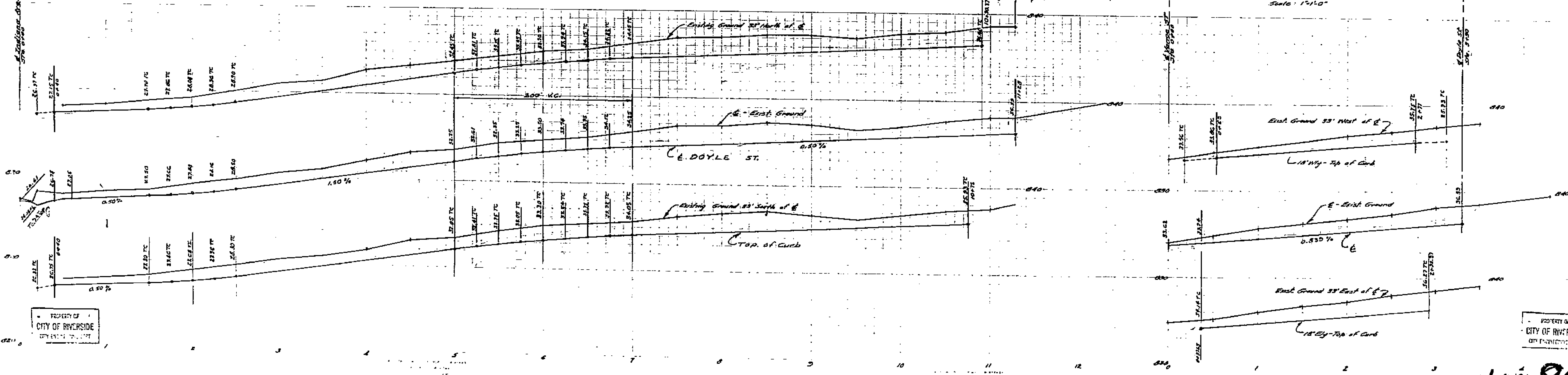
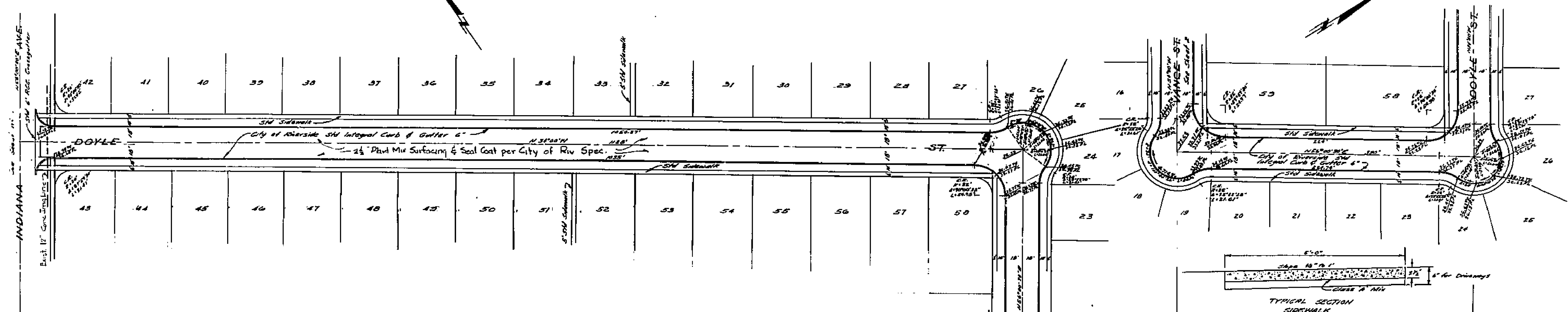

Approved by *W.H. Davidson*
City Engineer

PLAN & PROFILE
HARMONY-DALE TRACT
DOYLE ST.

JANUARY 1954 J.F. DAVIDSON
SCALE: HOR. 1" = 20'
VERT. 1" = 2'

1485

PROPERTY OF
CITY OF RIVERSIDE
CITY ENGINEERING DEPT.

PROPERTY OF
CITY OF RIVERSIDE
CITY ENGINEERING DEPT.

1485

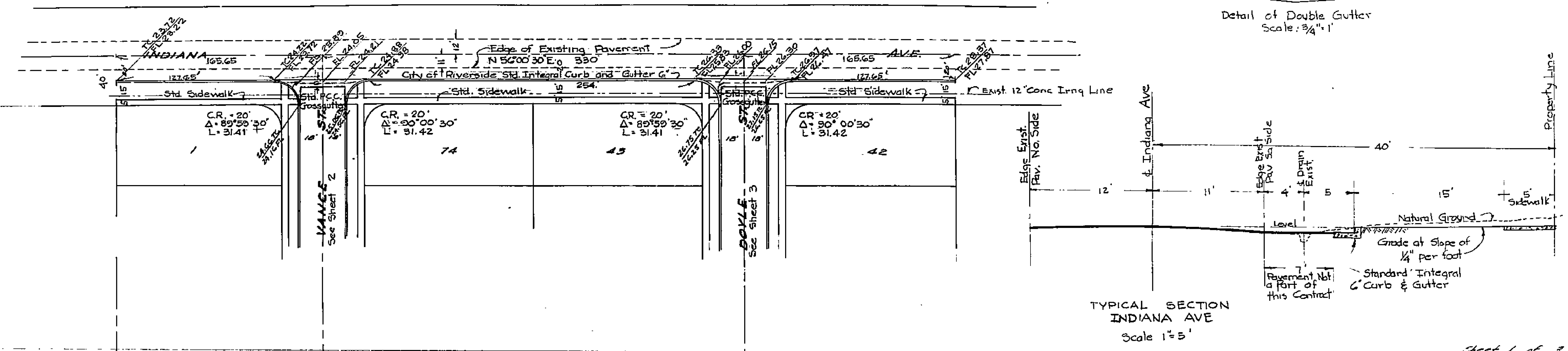
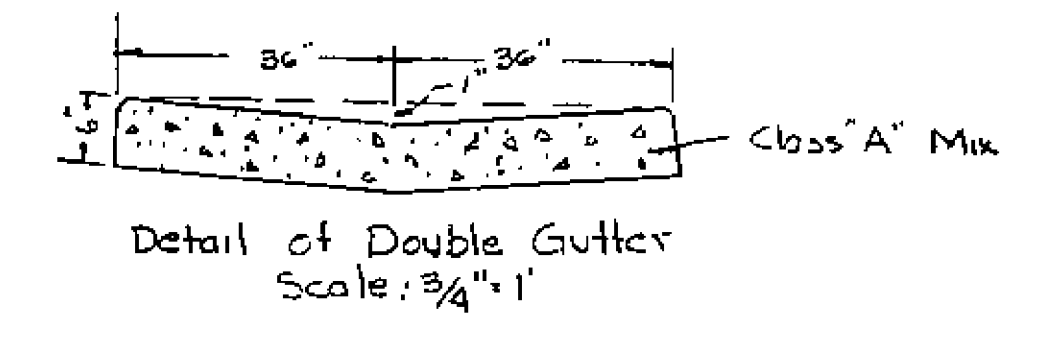
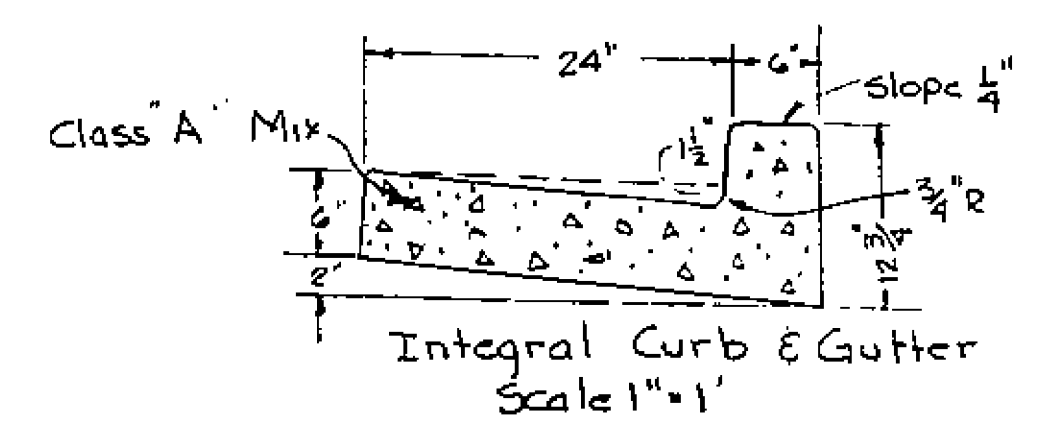

Sheet 1 of 3 Sheets

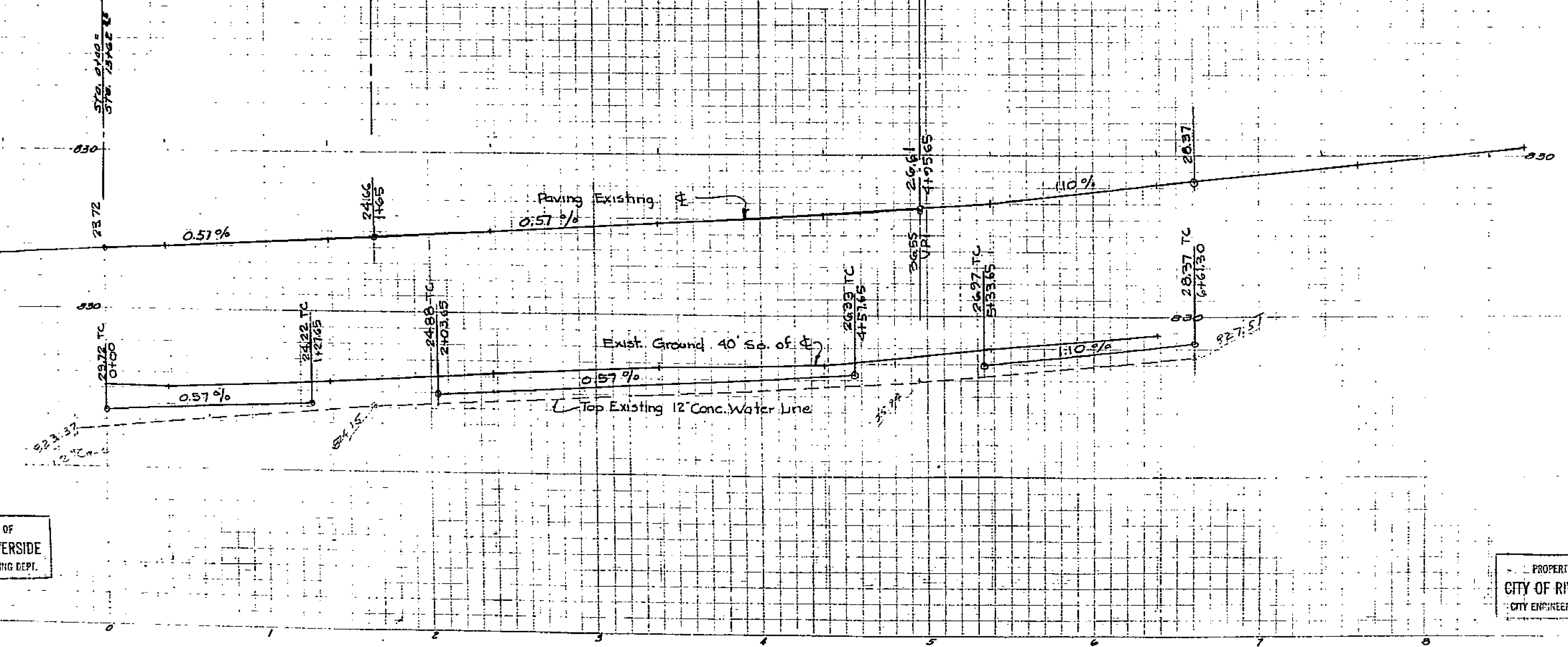

Approved by *M. H. Irvine*
City Engineer

PLAN & PROFILE
HARMONY-DALE TRACT
INDIANA AVE.

JANUARY 1954 J.F. DAVIDSON, C.E.

SCALE:
HOR. 1"=40'
VERT. 1"=4'

PROPERTY OF
CITY OF RIVERSIDE
CITY ENGINEERING DEPT.

PROPERTY OF
CITY OF RIVERSIDE
CITY ENGINEERING DEPT.

1485

ED. 445-1.5 1485

MADE IN U.S.A.
LEARRBRIHT PAPER CO.
GREEN BIRTH, MONTE BIRM RATE A