

PLANS & PROFILES
 NO. 724
 FOR THE IMPROVEMENT
 OF THE NORTH DRIVE OF
MAGNOLIA AVENUE

MADISON STREET TO ADAMS STREET
 ENGINEERING DEPT. RIVERSIDE, CALIF.
 CITY (U.S.G.S.) DATUM PLANE

APPROVED: *M. H. Swain*
 CITY ENGINEER
 AN ENGINEER REGISTERED UNDER THE
 LAWS OF THE STATE OF CALIFORNIA
 REG. NO. 3011

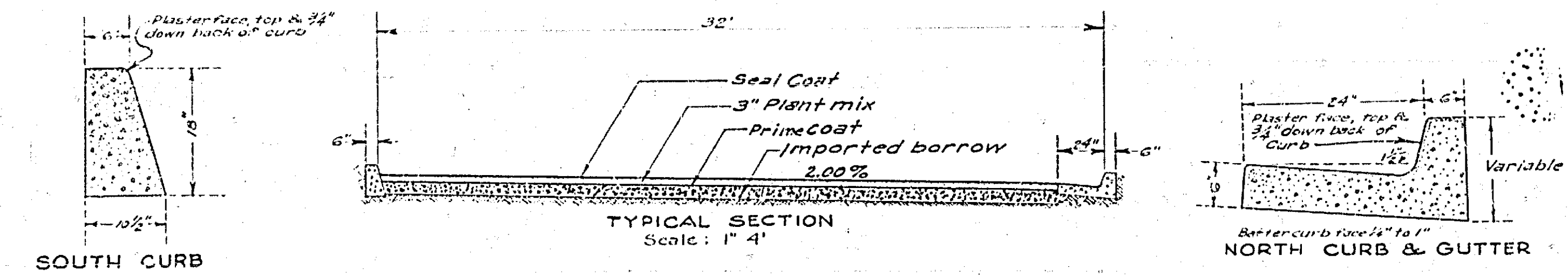

Note: The dimensions given refer, in case of plastered curb, to the size of curb before plaster has been applied to the face, but not to the top.
 Concrete: All class 2"

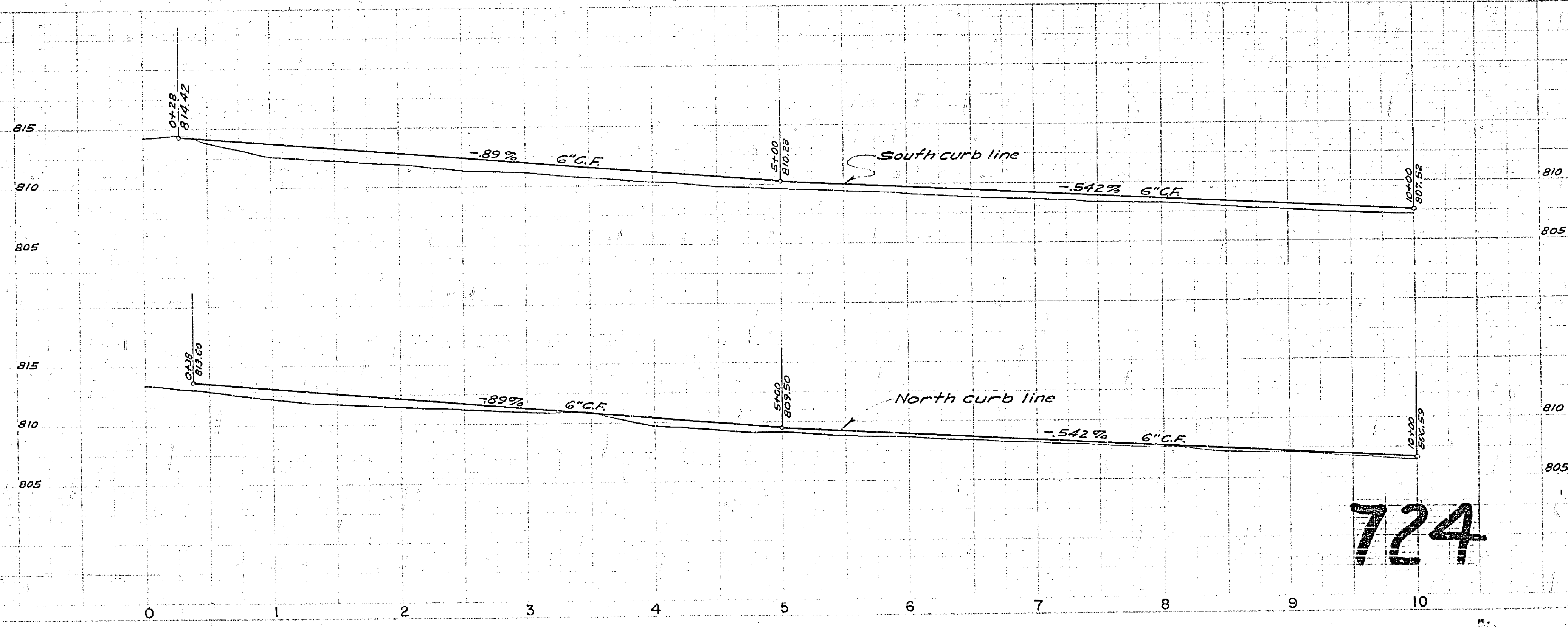
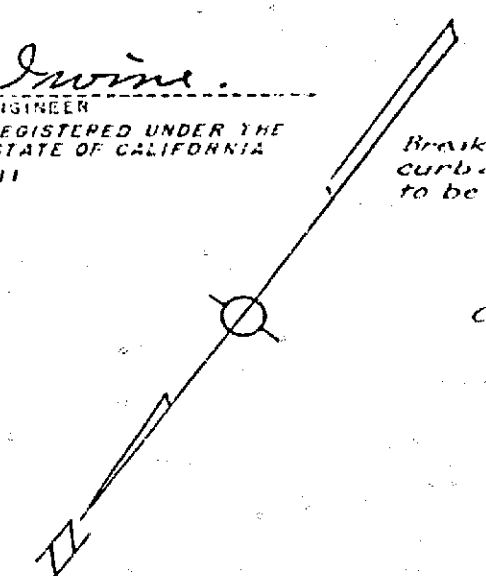
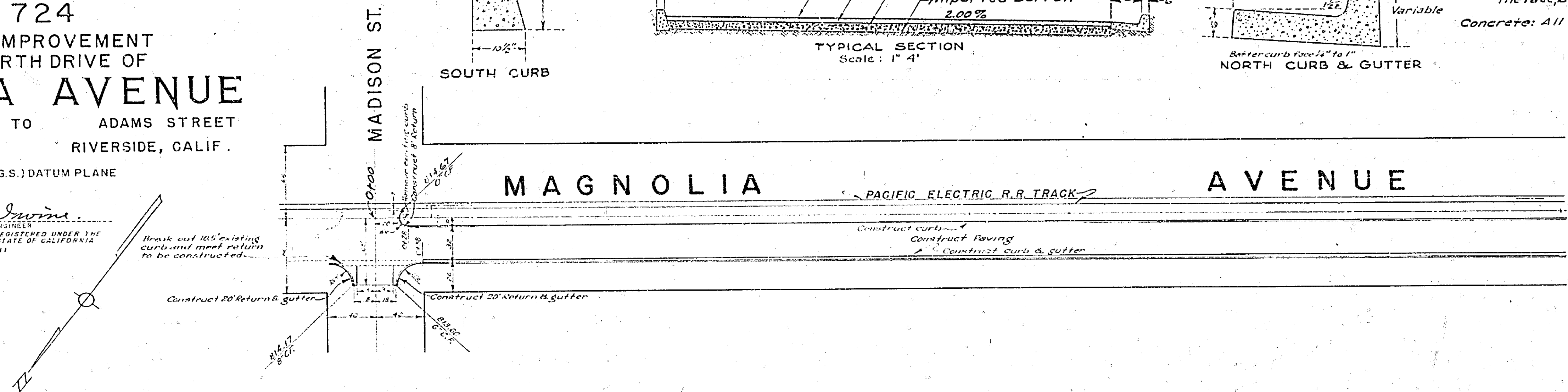

724

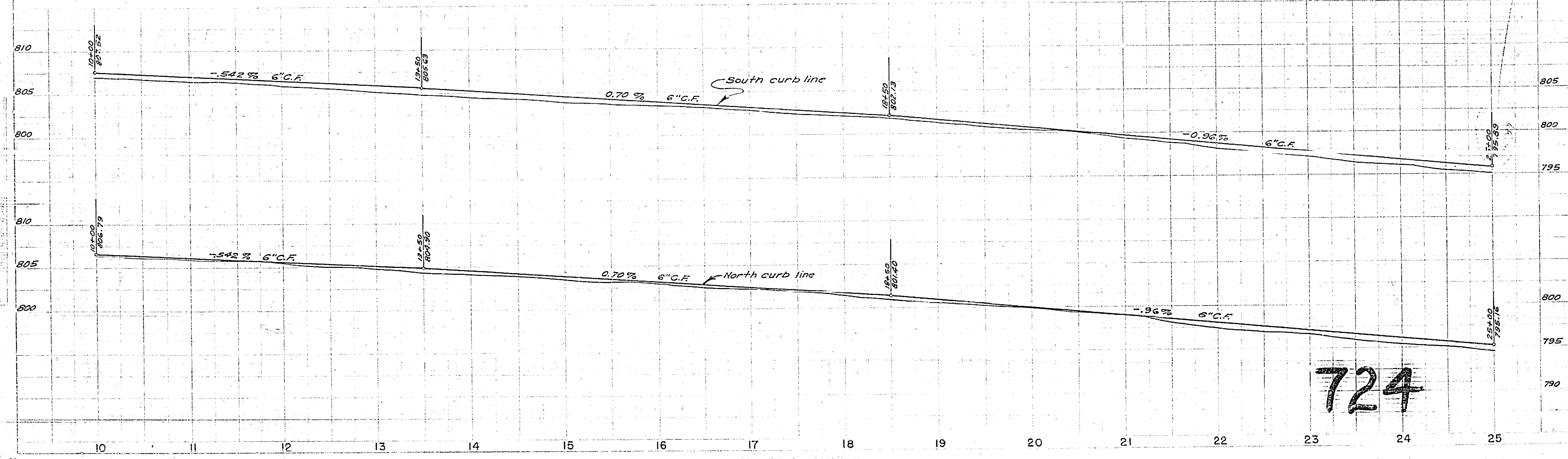
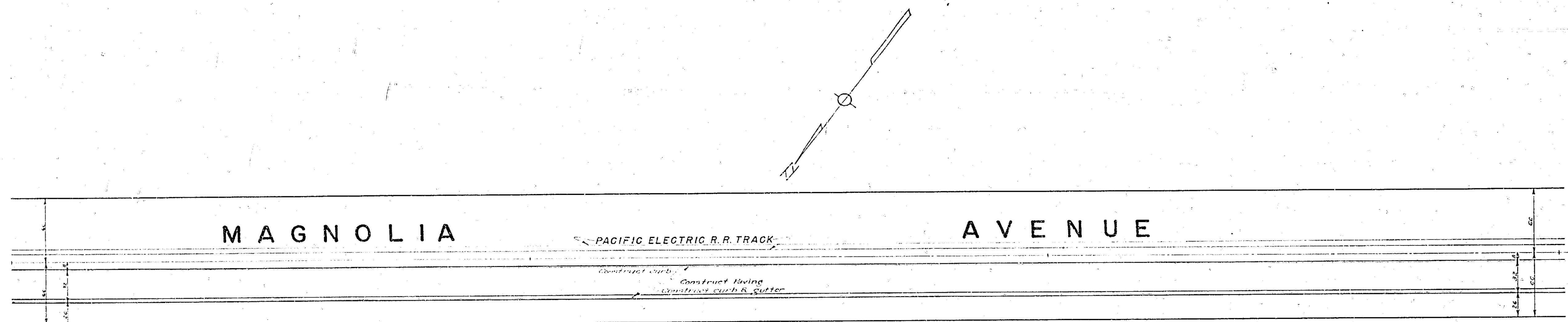

724

22"
17"
11"
8.5"
11"
17"
22"

22"
17"
11"
8.5"
11"
8.5"
11"
17"
22"

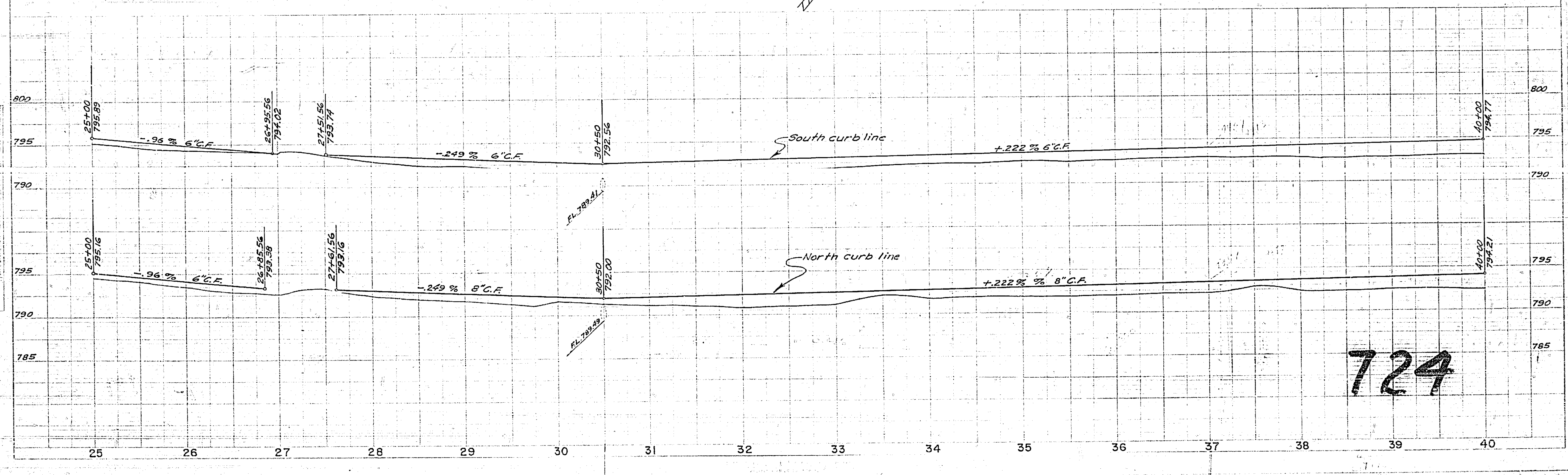
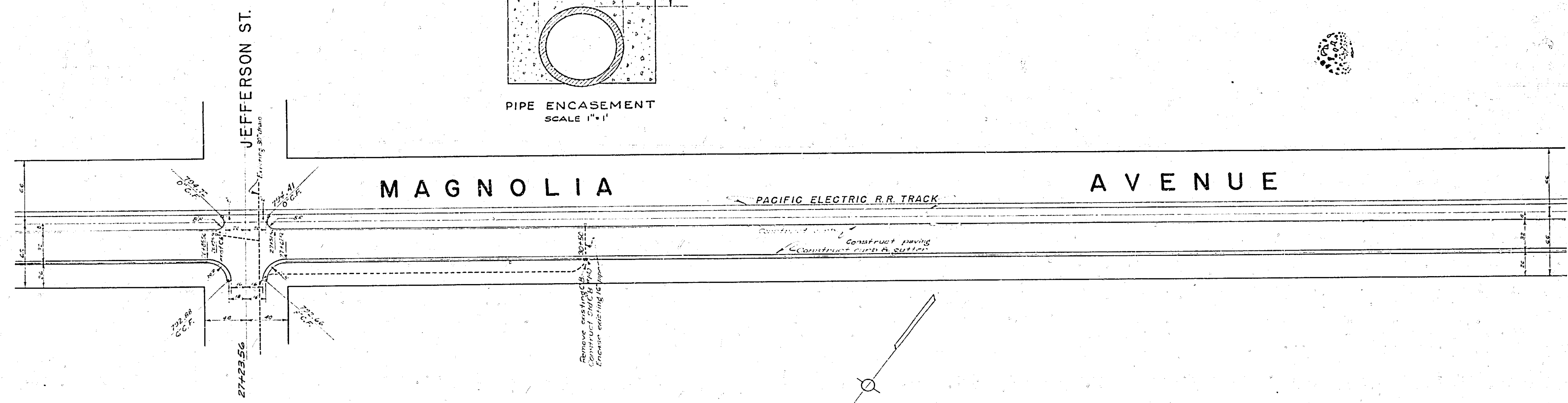
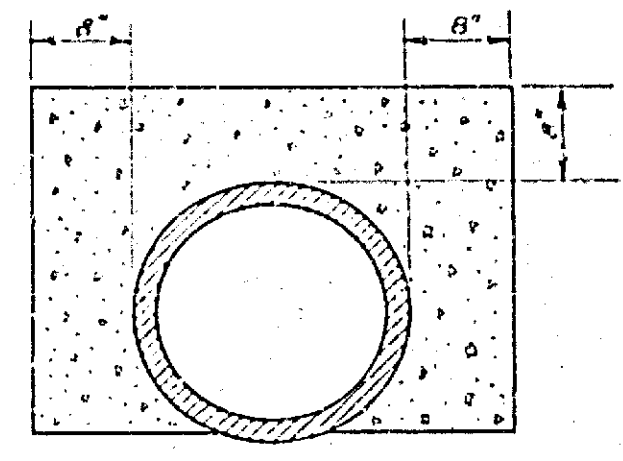

724

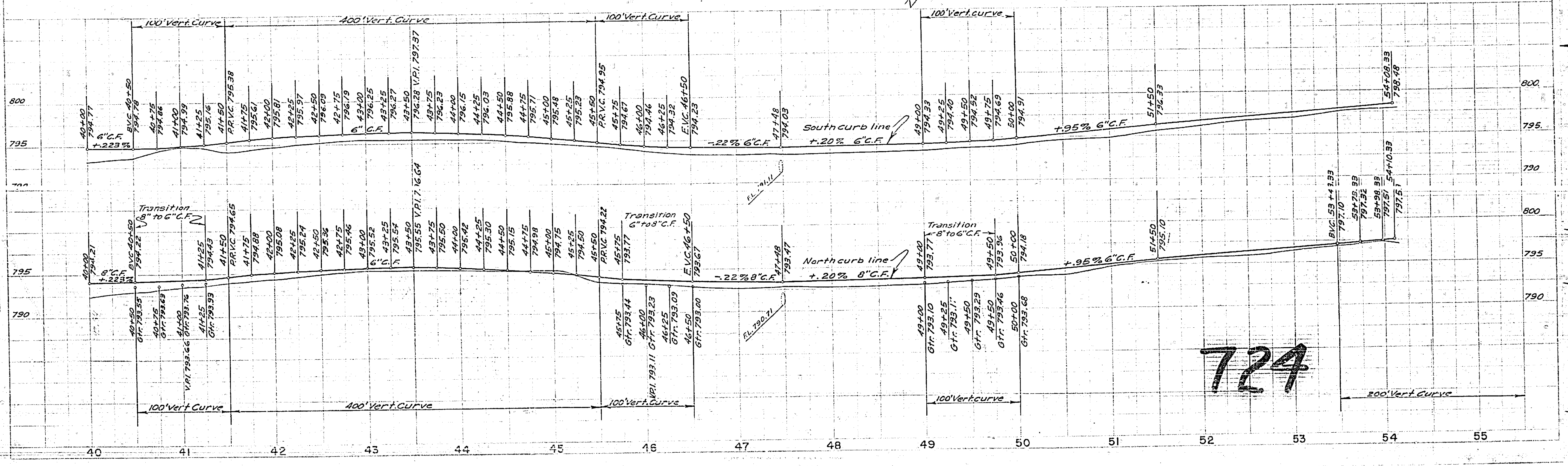
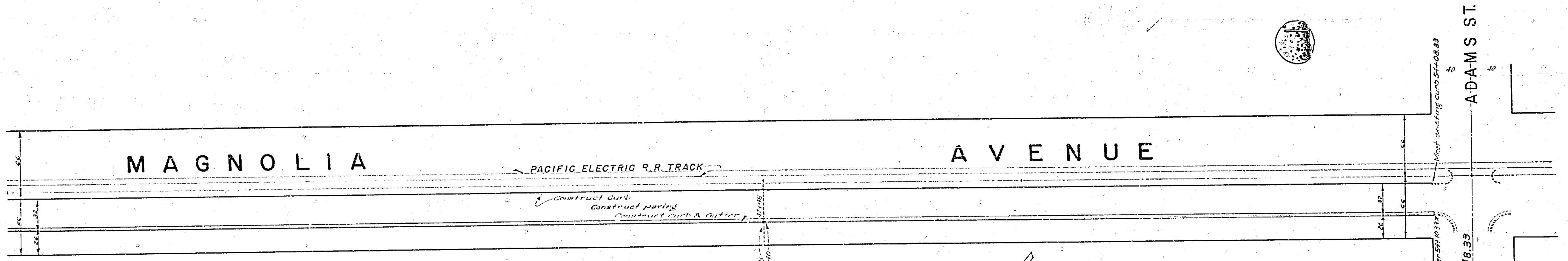

724

22"

17"

11"

8.5"

8.5"

11"

17"

22"

22"

17"

11"

8.5"

8.5"

11"

17"

22"