

**SIGNING AND STRIPING GENERAL NOTES:**

- SIGNING AND STRIPING INSTALLATIONS SHALL CONFORM TO THE 2014 CALIFORNIA MANUAL ON UNIFORM TRAFFIC CONTROL DEVICES (CA MUTCD), THE STATE OF CALIFORNIA DEPARTMENT OF TRANSPORTATION (CALTRANS) STANDARD PLANS AND SPECIFICATIONS DATED 2018, AND ALL ADDENDUMS THERETO, AND THE CITY OF RIVERSIDE PUBLIC WORKS DEPARTMENT STANDARD DRAWINGS, CURRENT EDITION.
- ALL STRIPING, MARKINGS, AND LEGENDS SHALL BE REFLECTORIZED THERMOPLASTIC UNLESS OTHERWISE NOTED. THE CONTRACTOR SHALL PROVIDE AND INSTALL RAISED PAVEMENT MARKERS FOR ALL STRIPING. STRIPING, MARKINGS AND LEGENDS SHALL CONFORM TO THE LATEST CALTRANS STANDARD PLANS A20A THRU A20D AND A24A THRU A24E.
- PRIOR TO FINAL ACCEPTANCE OF STREET IMPROVEMENTS, ALL PAVEMENT STRIPING AND STENCILING WITHIN THE PERIMETER OF THE CONSTRUCTION AREA SHALL BE RESTORED TO LIKE NEW CONDITION, IN A MANNER MEETING THE APPROVAL OF THE CITY OF RIVERSIDE.
- THE CONTRACTOR SHALL RE-STRIPE EXISTING STRIPING AND CURB MARKINGS OBLITERATED BY NEW CONSTRUCTION, WHETHER OR NOT SHOWN ON THE PLANS FOR REPLACEMENT, AT NO COST TO THE CITY.
- AT LOCATIONS WHERE EXISTING PAINTED CURB IS TO BE RECONSTRUCTED, THE CONTRACTOR SHALL PAINT THE NEW CURB AS SHOWN ON THE PLANS WITHIN 10 WORKING DAYS OF CURB CONSTRUCTION OR AS DIRECTED BY ENGINEER. THE PAINT SHALL BE WATER-BASED WITH 2-YEAR GUARANTEE AGAINST COLOR FADING. PRIOR TO THE START OF CONSTRUCTION, THE CONTRACTOR SHALL SUBMIT TO THE CITY WRITTEN PROOF OF THE MANUFACTURER'S 2-YEAR GUARANTEE.
- ALL NEW STRIPING SHALL BE "CAT TRACKED" AND APPROVED BY THE ENGINEER PRIOR TO FINAL INSTALLATION. THE CONTRACTOR SHALL NOTIFY THE ENGINEER AFTER COMPLETING LAYOUT AND AT LEAST 3 WORKING DAYS BEFORE COMMENCING INSTALLATION OF STRIPING, MARKINGS AND MARKERS.
- TRAFFIC SIGN FACE SHALL BE 3M DIAMOND GRADE D63 REFLECTIVE SHEETING (ASTM XI) OR APPROVED EQUAL WITH PROTECTIVE GRAFTITI OVERLAY FILM OR AS OTHERWISE NOTED. ALL WARNING SIGNS SHALL HAVE A FLUORESCENT YELLOW BACKGROUND AND SCHOOL SIGNS NOTED SHALL HAVE A FLUORESCENT YELLOW-GREEN BACKGROUND.
- SIGNS SHALL BE STANDARD SIZE UNLESS NOTED OTHERWISE. PRIOR TO INSTALLATION, NEW SIGNS SHALL BE APPROVED BY THE CITY OF RIVERSIDE. EXACT LOCATIONS OF SIGNS SHALL BE DETERMINED BY THE CITY ENGINEER.
- ALL EXISTING SIGNS AND POSTS TO BE REMOVED SHALL BE DELIVERED TO THE CITY OF RIVERSIDE SIGN DEPARTMENT.
- WHEN PAINT IS SPECIFIED, TRAFFIC STRIPES AND MARKINGS SHALL BE APPLIED IN TWO COATS. A MINIMUM OF SEVEN DAYS SHALL BE PROVIDED BETWEEN FIRST AND SECOND COATS.
- STRIPING SHALL BE APPLIED WITHIN 48 HOURS OF SURFACE COURSE REPLACEMENT ON STREETS OPEN TO THE PUBLIC. IN NO CASE SHALL A NEWLY PAVED STREET OPEN TO THE PUBLIC BE LEFT UNSTRIPED OVER A WEEKEND OR HOLIDAY.
- CONTRACTOR SHALL INSTALL NEW SIGN(S) AND/OR POST(S) PER CITY OF RIVERSIDE STANDARD DRAWING No. 664, SEE SPECIFICATIONS. CONTRACTOR SHALL INSTALL NEW STREET NAME SIGNS AND POST PER CITY OF RIVERSIDE STANDARD DRAWING No. 662, SEE SPECIFICATIONS.
- ALL CONFLICTING STRIPING, PAVEMENT MARKINGS, LEGENDS, AND RAISED PAVEMENT MARKERS SHALL BE REMOVED EVEN IF NOT SHOWN ON PLANS. REMOVALS OF PAINTED STRIPING, PAVEMENT MARKINGS AND LEGENDS SHALL BE DONE BY WET SANDBLASTING. REMOVALS OF THERMOPLASTIC STRIPING, PAVEMENT MARKINGS AND LEGENDS SHALL BE REMOVED BY WET SANDBLASTING, GRINDING OR OTHER APPROVED METHOD AND SHALL NOT DAMAGE THE PAVEMENT. "BLACK OUT" OF EXISTING DELINEATION IS NOT PERMITTED. ALL DAMAGED PAVEMENT DUE TO REMOVALS SHALL BE REPAIRED AS NECESSARY TO MAINTAIN A SMOOTH AND UNIFORM SURFACE OR AS DIRECTED BY THE ENGINEER. ALL STRIPING REMOVALS AND LEGENDS SHALL BE "FOG SEALED".
- WHERE APPLICABLE, OUTBOUND LANE LINE DETAILS SHALL COMMENCE AT THE CROSSWALK, MEANING THE PAINTED PORTION OF THE DETAIL SHALL JOIN THE CROSSWALK.

**TRAFFIC SIGNAL GENERAL NOTES:**

- ALL ITEMS FURNISHED AND ALL WORK TO BE DONE SHALL CONFORM TO THE REQUIREMENTS OF THE STATE OF CALIFORNIA, DEPARTMENT OF TRANSPORTATION (CALTRANS) STANDARD PLANS AND SPECIFICATIONS, DATED 2018; THE CALIFORNIA MANUAL ON UNIFORM TRAFFIC CONTROL DEVICES ADOPTED 2014; AND THE SPECIAL PROVISIONS.
- UTILITIES SHOWN ON THE PLAN ARE CORRECT AND ACCURATE TO THE EXTENT OF AVAILABLE RECORDS. THE CONTRACTOR IS REQUIRED TO TAKE STEPS TO ASCERTAIN THE EXACT LOCATION OF ALL KNOWN SUBSTRUCTURES PRIOR TO DOING WORK THAT MAY DAMAGE OR INTERFERE WITH SUCH FACILITIES ("UNDERGROUND SERVICE ALERT" (800) 227-2600).
- UNLESS SHOWN OTHERWISE, INDUCTIVE LOOPS SHALL BE MODIFIED TYPE "D" & TYPE "E" WITH 10', 15' AND 30' SPACING IN THE DIRECTION OF TRAVEL. NECESSARY STRIPING SHALL BE LOCATED PRIOR TO POSITIONING LOOPS. LOOPS SHALL BE SEALED WITH HOT MELT SEALANT. SEE DETAIL.
- UNDERGROUND SIGNAL CONDUCTORS SHALL NOT BE SPLICED.
- THE CONTRACTOR SHALL VERIFY WITH THE ENGINEER THE PRECISE FIELD LOCATIONS OF ALL TRAFFIC SIGNAL EQUIPMENT PRIOR TO THE INSTALLATION.
- ALL LANDSCAPING WHICH IS DAMAGED BY CONSTRUCTION ACTIVITIES SHALL BE REPAIRED OR REPLACED TO THE SATISFACTION OF THE CITY AND THE PROPERTY OWNER.
- DAMAGED SIDEWALK CONCRETE SHALL BE REPLACED PER CITY OF RIVERSIDE STANDARD.
- IT SHALL BE THE RESPONSIBILITY OF THE CONTRACTOR TO FURNISH AND INSTALL ANY ADDITIONAL LOAD SWITCHES AND/OR DETECTOR CARDS, IF NECESSARY, FOR THE PROPOSED OPERATION.

**SIGNING AND STRIPING LEGEND:**

- E EXISTING TO REMAIN.
- SC SPLICE TO EXISTING CONDUCTORS.
- I INSTALL LOOP DETECTOR AS NOTED ON PLAN.
- # INSTALL CALTRANS STRIPING DETAIL PER NUMBER NOTED, INCLUDING INSTALLATION OF RAISED PAVEMENT MARKERS.
- PM INSTALL PAVEMENT MARKING OR ARROW AS NOTED.
- RP REMOVE ALL EXISTING CONFLICTING TRAFFIC STRIPING AND MARKINGS AS NOTED, INCLUDING RAISED PAVEMENT MARKERS.
- RR REMOVE AND REPLACE EXISTING SIGN POST WITH 2" SQUARE 12 GAUGE PERFORATED POST
- IS FURNISH AND INSTALL ROADSIDE SIGN(S) OR SNS WITH/WITHOUT POST
- RS REMOVE SIGN(S) WITH/WITHOUT POST AS NOTED ON PLAN
- RL RELOCATE EXISTING SIGN(S) TO EXISTING POST OR INSTALL POST (IF APPLICABLE)
- S EXISTING SIGNALIZED INTERSECTION
- o PROPOSED SIGN (ONE POST)
- + PROPOSED STREET NAME SIGN
- o EXISTING SIGN (ONE POST)
- o EXISTING/PROPOSED SIGN (ON STREET LIGHT)
- + EXISTING STREET NAME SIGN
- SNS STREET NAME SIGN
- (12') EXISTING WIDTH
- 12' PROPOSED WIDTH

**ROADSIDE SIGNS (STANDARD SIZE):**

SEE CITY OF RIVERSIDE STANDARD DWG NO. 664 FOR SIGN STANDARDS

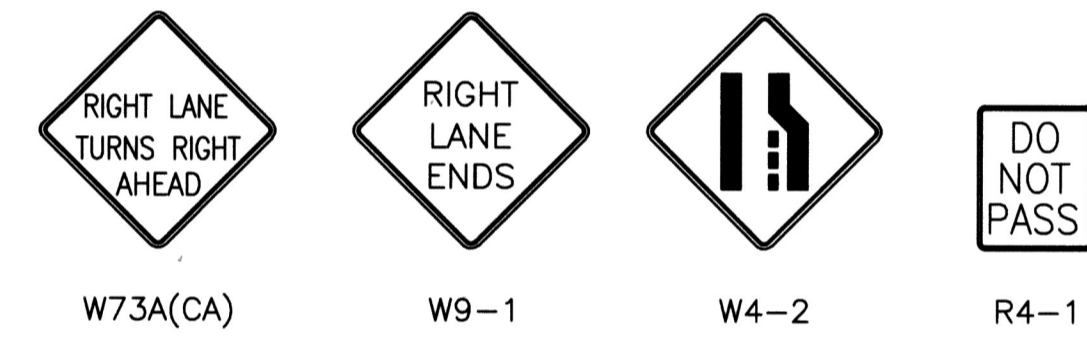

**SNS DETAILS - XL808**

INTERSECTION	PANEL No. 1	PANEL No. 2
WASHINGTON ST & HERMOSA DR	Washington St 5100	Hermosa Dr 1700
WASHINGTON ST & GLADSTONE BLVD	Washington St 1200	Gladstone Blvd 1700
WASHINGTON ST & HIGHRIDGE ST	Washington St 1600	Highridge St 1600
WASHINGTON ST & DUSTIN PL	Washington St 1500	Dustin Pl 1600
WASHINGTON ST & KITCHENER ST	Washington St 1600	MAINTAIN EXISTING
WASHINGTON ST & DUFFERIN AVE	Washington St 1600	MAINTAIN EXISTING
WASHINGTON ST & ENDEL DR	Washington St 2300	Engel Dr 2300
WASHINGTON ST & FIRESIDE DR	Washington St 2300	Fireside Dr 7000
WASHINGTON ST & MOONSTONE CIR	Washington St 2400	Moonstone Cir 7000
WASHINGTON ST & FRANCES ST	Washington St 2500	Frances St 7000

SEE CITY OF RIVERSIDE STANDARD DWG NO. 662 FOR STREET NAME SIGN STANDARDS

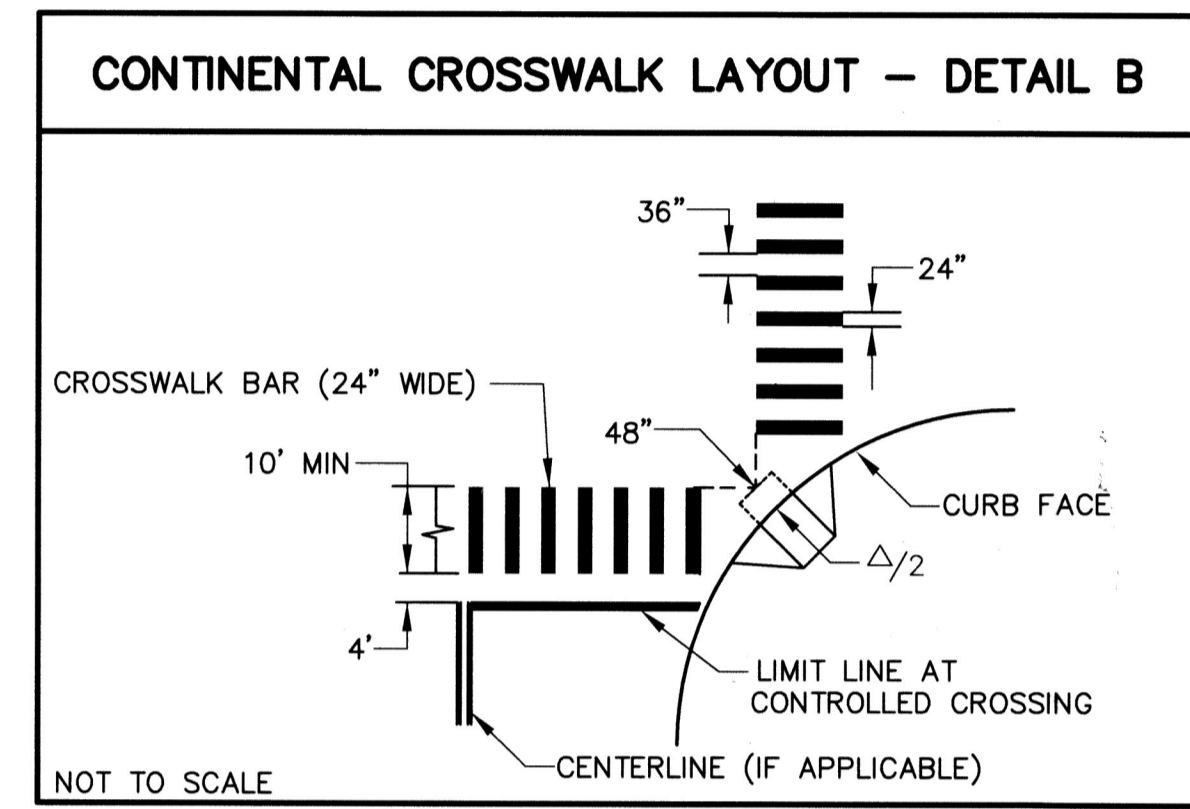
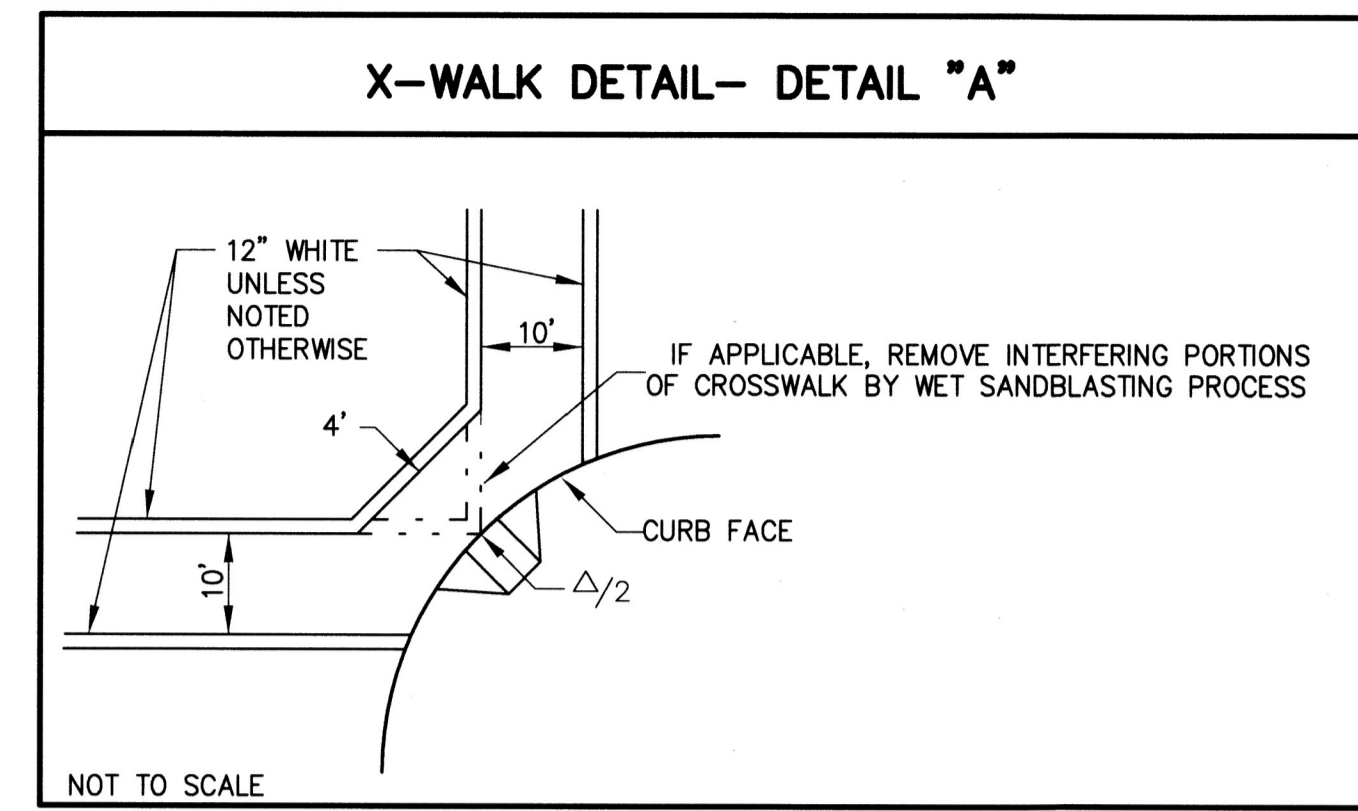

**QUANTITIES - XL-808**

ITEM	DESCRIPTION	QUANTITY	UNIT
1	DETAIL 9	3,975	LF
2	DETAIL 22	12,030	LF
3	DETAIL 27B	14,050	LF
4	DETAIL 29	6,800	LF
5	DETAIL 32	12,040	LF
6	DETAIL 37B	320	LF
7	DETAIL 38	1,430	LF
8	6" SOLID WHITE	170	LF
9	8" SOLID WHITE	385	LF
10	8" SOLID YELLOW	56	LF
11	12" SOLID WHITE	224	LF
12	PAVEMENT LEGENDS/MARKINGS - WHITE	1,496	SF
13	ROADSIDE SIGN - ONE POST	6	EA
14	RELOCATE SIGN AND POST	4	EA
15	SNS - ONE POST	6	EA
16	SNS - NO POST	3	EA
17	REMOVE AND REPLACE SIGN POST	6	EA
18	REMOVE SIGN - ONE POST	3	EA
19	REMOVE SIGN - NO POST	6	EA
20	TYPE "D" LOOP DETECTOR	9	EA
21	TYPE "E" LOOP DETECTOR	22	EA
22	DLC - DETECTOR LOOP CABLE	710	LF
23	SC - SPLICE NEW TO EXISTING	8	EA

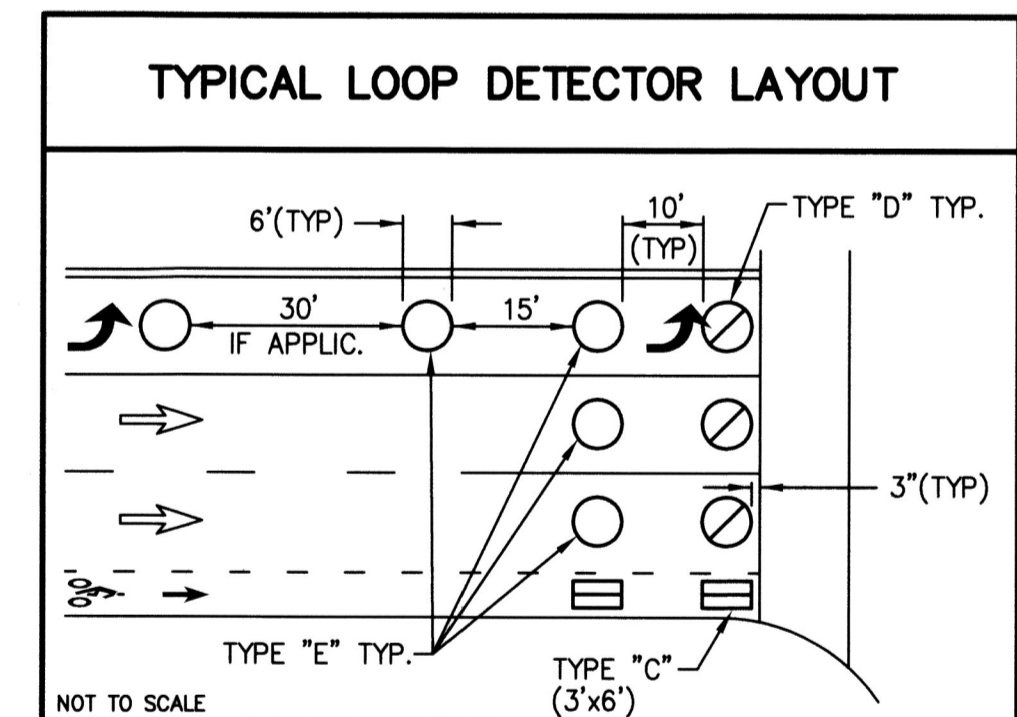

SEE CITY OF RIVERSIDE STANDARD DWG NO. 670 FOR TYPE "D" AND TYPE "E" LOOP CONFIGURATION

(R-4485) LOCATION 5  
2019/2020 ARTERIAL AND MINOR  
STREETS MAINTENANCE, PHASE 2

Under Ground  
Service Alert  
of Southern California  
Call: TOLL FREE  
1-800  
227-2600  
TWO WORKING DAYS BEFORE YOU DIG

**ENGINEER IN RESPONSIBLE CHARGE**  
NATHAN T. MUSTAFA  
R.C.E. No. 83654 EXPIRES: 3-31-23  
DATE: 12/6/21

REGISTERED PROFESSIONAL ENGINEER  
NATHAN T. MUSTAFA  
No. 83654  
Exp. 03-31-23  
CIVIL  
STATE OF CALIFORNIA

DESIGNED BY: FDM    DRAWN BY: FDM    CHECKED BY: NTM

**CITY OF RIVERSIDE, CALIFORNIA  
DEPARTMENT OF PUBLIC WORKS**

APPROVED BY: *[Signature]* DATE: Dec 3, 2021  
PRINCIPAL ENGINEER  
TRAFFIC DIVISION: *[Signature]* DATE: 12/9/21  
CONSTRUCTION ADMIN.

**SIGNING AND STRIPING PLAN  
WASHINGTON STREET  
FROM VICTORIA AVENUE  
TO HERMOSA DRIVE**

**XL-808**  
SHEET 1 OF 4  
SCALE: N/A    WORK ORDER #2002631    FILE NAME: XL808.DWG

WASHINGTON STREET

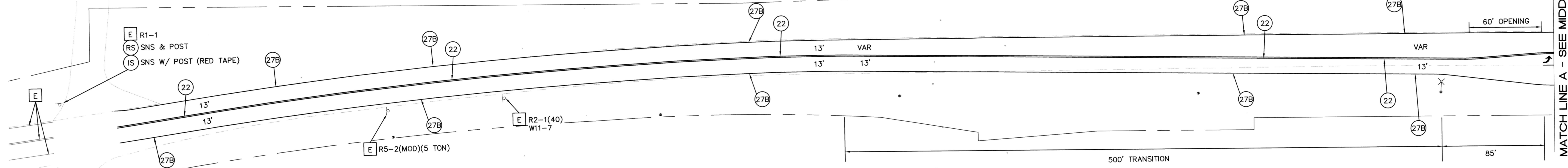

CONSTRUCTION NOTES (THIS SHEET):

SEE NOTES ON SHEET 01 (PLAN NO. XL-808)

HERMOSA DRIVE

GLADSTONE BOULEVARD

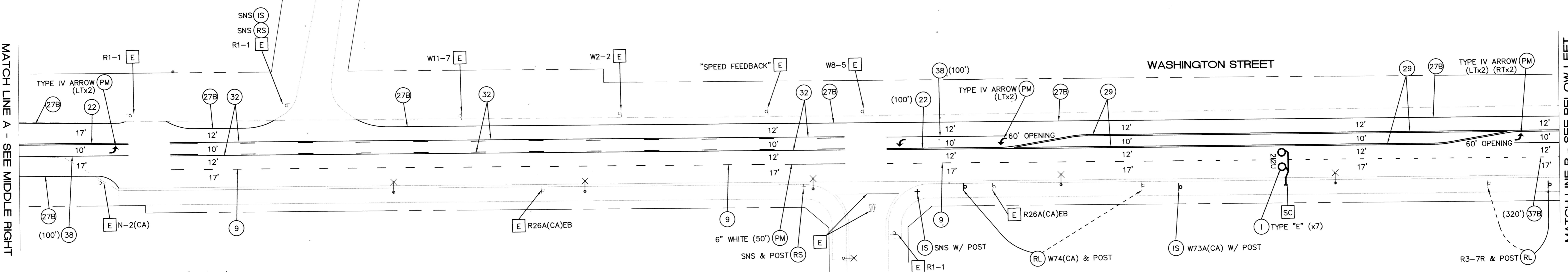

HIGHRIDGE STREET

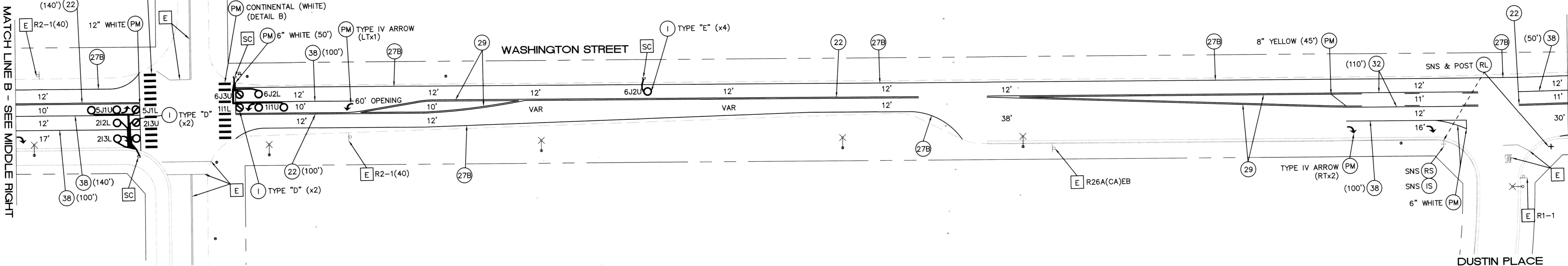

BRADLEY STREET

DUSTIN PLACE

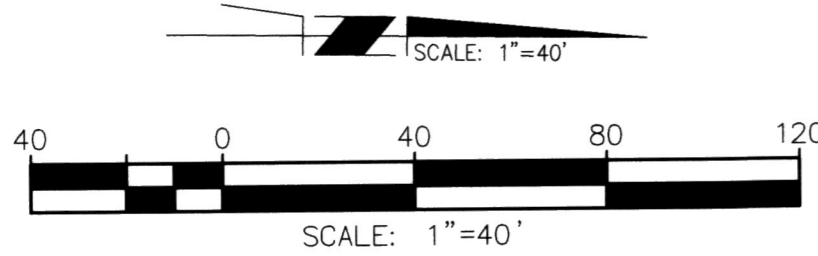

Under Ground Service Alert of Southern California  
Call: TOLL FREE 1-800 227-2600  
TWO WORKING DAYS BEFORE YOU DIG



ENGINEER IN RESPONSIBLE CHARGE  
NATHAN T. MUSTAFA  
R.C.E. No. 83654 EXPIRES: 3-31-23  
DATE: 3-30-21



MARK	REVISIONS	APPR.	DATE
DESIGNED BY	FDM	DRAWN BY	FDM
CHECKED BY			NTM

CITY OF RIVERSIDE, CALIFORNIA DEPARTMENT OF PUBLIC WORKS			
APPROVED BY	BY	DATE	APPROVED BY
ENGINEERING MANAGER	FM	4/1/21	CITY ENGINEER
PRINCIPAL ENGINEER			
TRAFFIC DIVISION			
CONSTRUCTION ADMIN.	PL	3/30/21	DATE: March 26, 2021

SIGNING AND STRIPING PLAN	
WASHINGTON STREET FROM VICTORIA AVENUE TO HERMOSA DRIVE	
SCALE: 1" = 40'	WORK ORDER #2002631

XL-808  
SHEET 2 OF 4  
FILE NAME: XL808.DWG

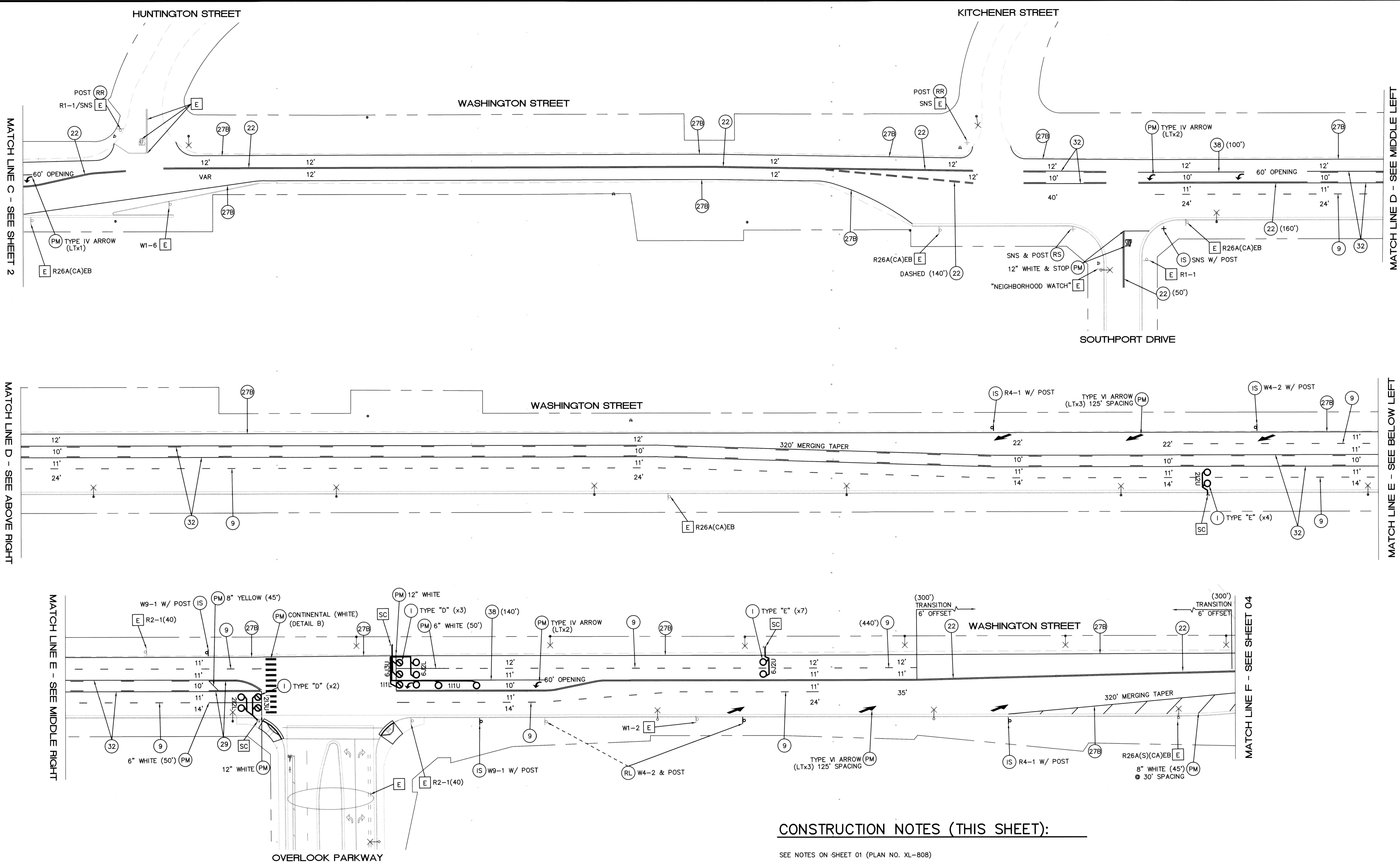

**CONSTRUCTION NOTES (THIS SHEET):**

SEE NOTES ON SHEET 01 (PLAN NO. XL-808)

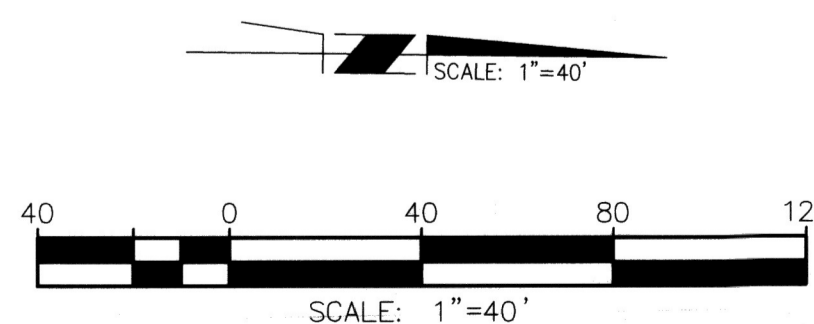

Under Ground Service Alert of Southern California  
 Call: TOLL FREE 1-800-227-2600  
 TWO WORKING DAYS BEFORE YOU DIG

**CITY OF RIVERSIDE**  
 ENGINEER IN RESPONSIBLE CHARGE  
 NATHAN T. MUSTAFA  
 R.C.E. No. 83654 EXPIRES: 3-31-23  
 DATE: 2-30-21

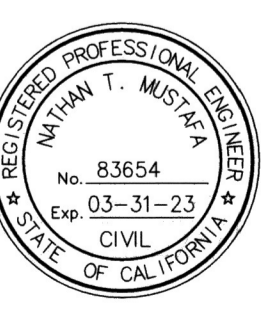

MARK	REVISIONS	APPR.	DATE
DESIGNED BY	FDM	DRAWN BY	FDM
CHECKED BY			NTM

**CITY OF RIVERSIDE, CALIFORNIA**  
**DEPARTMENT OF PUBLIC WORKS**

APPROVED BY	BY	DATE	APPROVED BY
ENGINEERING MANAGER	Fm	4/11/21	[Signature]
PRINCIPAL ENGINEER			CITY ENGINEER
TRAFFIC DIVISION			
CONSTRUCTION ADMIN.	DC	3/30/21	DATE: March 26, 2021

**SIGNING AND STRIPING PLAN**  
**WASHINGTON STREET**  
 FROM VICTORIA AVENUE  
 TO HERMOSA DRIVE  
 SCALE: 1" = 40'  
 WORK ORDER #2002631

**XL-808**  
 SHEET **3** OF **4**  
 FILE NAME: XL808.DWG

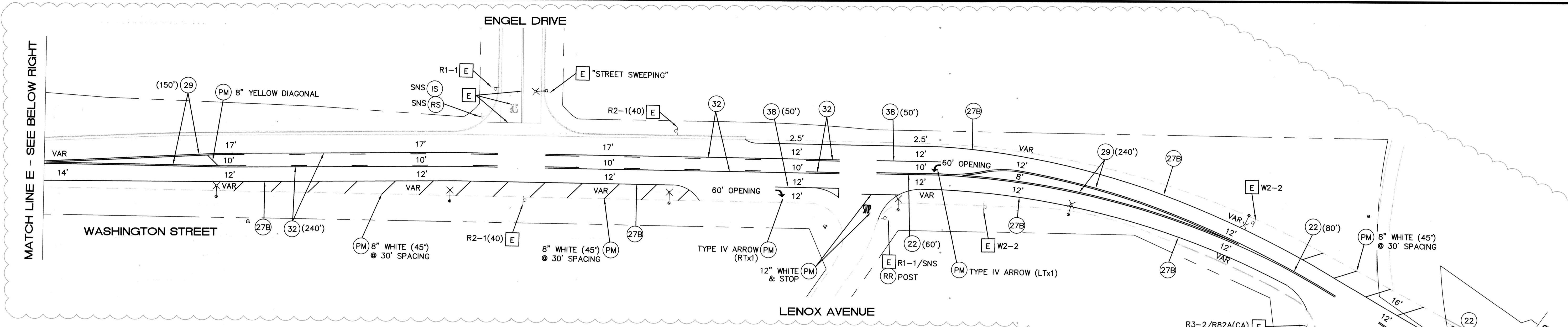

**CONSTRUCTION NOTES (THIS SHEET):**

SEE NOTES ON SHEET 01 (PLAN NO. XL-808)

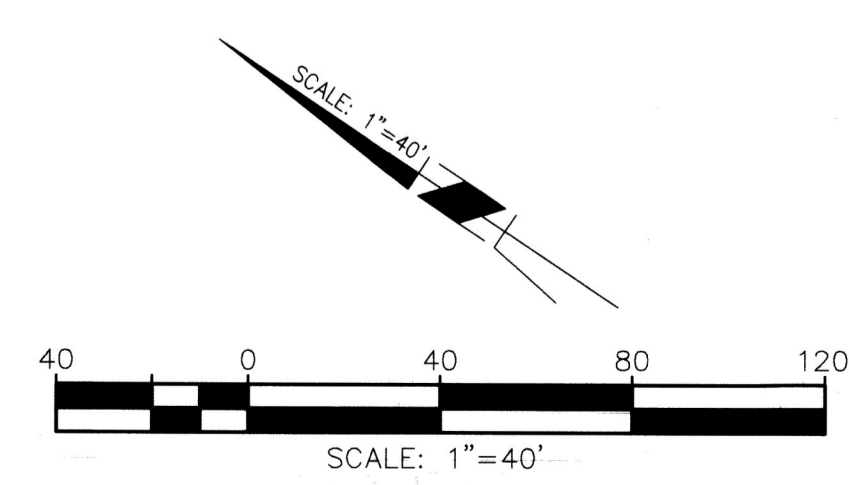
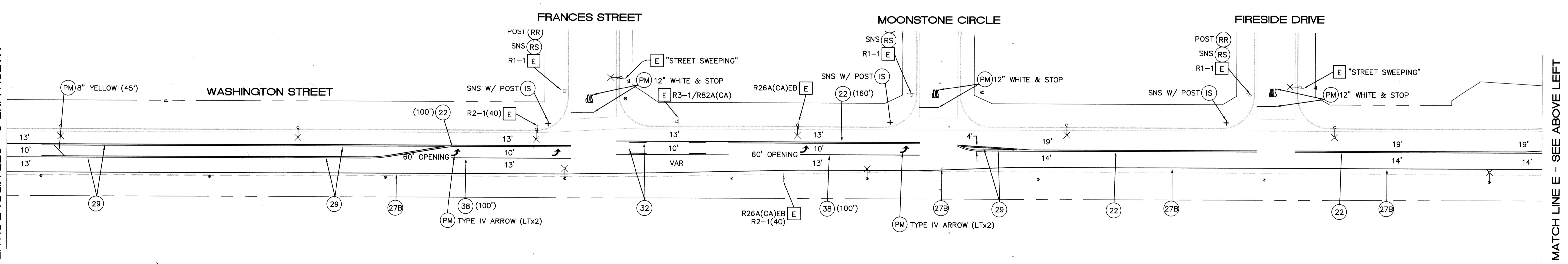
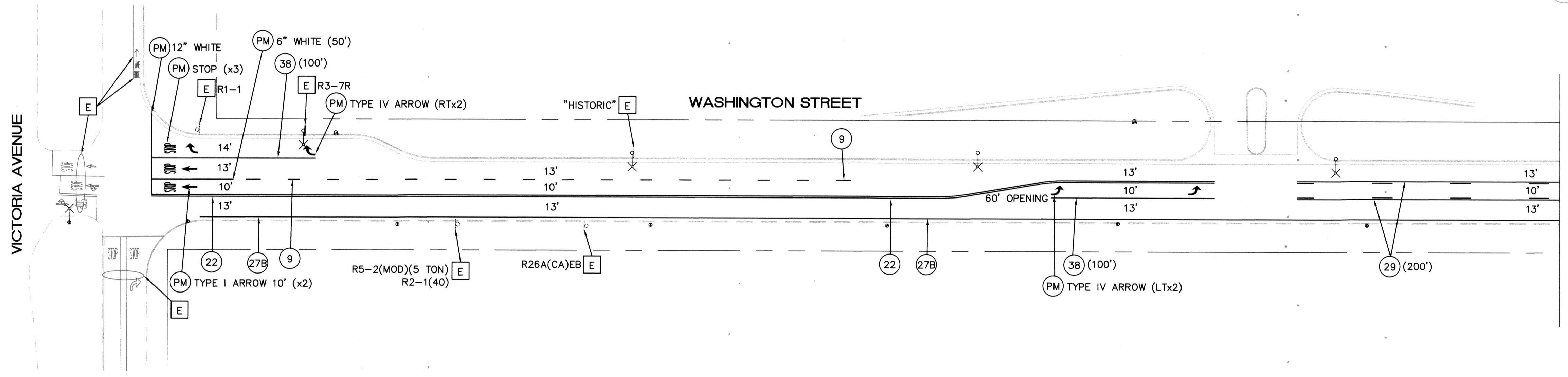

Under Ground Service Alert of Southern California  
 Call: TOLL FREE 1-800-227-2600  
 TWO WORKING DAYS BEFORE YOU DIG

**ENGINEER IN RESPONSIBLE CHARGE**  
 NATHAN T. MUSTAFA  
 R.C.E. No. 83654 EXPIRES: 3-31-23  
 DATE 12/6/21

MARK	REVISIONS	APPR.	DATE
Δ	REVISED STRIPING - ADDED LT POCKET ONTO LENOX AVE		

CITY OF RIVERSIDE, CALIFORNIA DEPARTMENT OF PUBLIC WORKS			
APPROVED BY	BY	DATE	APPROVED BY
ENGINEERING MANAGER			
PRINCIPAL ENGINEER			
TRAFFIC DIVISION	PN	12/9/21	CITY ENGINEER
CONSTRUCTION ADMIN.			
DESIGNED BY	FDM	DRAWN BY	FDM
CHECKED BY			NTM

SIGNING AND STRIPING PLAN	
WASHINGTON STREET FROM VICTORIA AVENUE TO HERMOSA DRIVE	
SCALE: 1" = 40'	WORK ORDER #2002631

**XL-808**  
 SHEET 4 OF 4  
 FILE NAME: XL808.DWG