

(B) SYMBOL INDICATES THE APPROXIMATE LOCATION OF A STENCIL.
 THE "L" REPRESENTS THE "BIKE LANE" AND ARROW.

GENERAL NOTES:

1. THESE STRIPING PLANS ARE ACCURATE FOR STRIPING, PAVEMENT MARKINGS AND NEW SIGN INSTALLATIONS.
2. SEE COVER SHEET FOR INFORMATION REGARDING SIGN INSTALLATION IN PORTLAND CONCRETE AREAS.
3. SEE SHEETS 1 THRU 10 FOR EXISTING SIGN REQUIREMENTS.
4. INSTALLATION OF NEW SIGNS SHALL INCLUDE BOTH SIGN(S) AND POST.
5. ALL SIGNS (NEW, RELOCATED AND THOSE THAT REMAINED IN PLACE) ARE SHOWN ON THESE PLANS. SEE NOTES 1 AND 3.

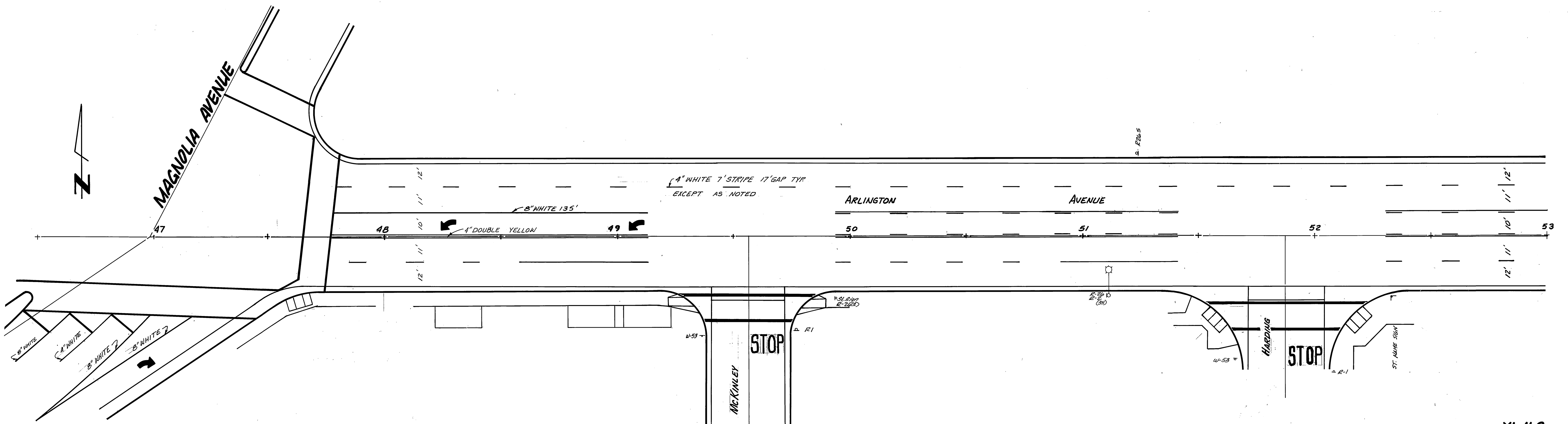

CITY OF RIVERSIDE PUBLIC WORKS DEPARTMENT		ACC. No. 30-579-323 XL-168 ACCOUNT NO. 30-579-34-07 R-2459
APPROVED BY <small>PRINCIPAL ENGINEER</small> DATE: 5-27-88 <small>TRAFFIC DIVISION</small> 8/23/87 <small>INSPECTION</small> 3/8/88 <small>DEPUTY PW DIR.</small> 3.22.88	APPROVED BY <i>Barry Bell</i> <small>PUBLIC WORKS DIRECTOR</small> DATE: 11-23-1988	ARLINGTON AVENUE REHABILITATION STRIPING AND SIGNING MAGNOLIA AVE. TO A.T. & S.F. R.R. SHEET 13 OF 21
DESIGNED BY: _____ DRAWN BY: <i>T.L.</i> CHECKED BY: <i>D.C.</i>		HORIZ. SCALE: 1" = 20' VERT. SCALE: 1" = 20'

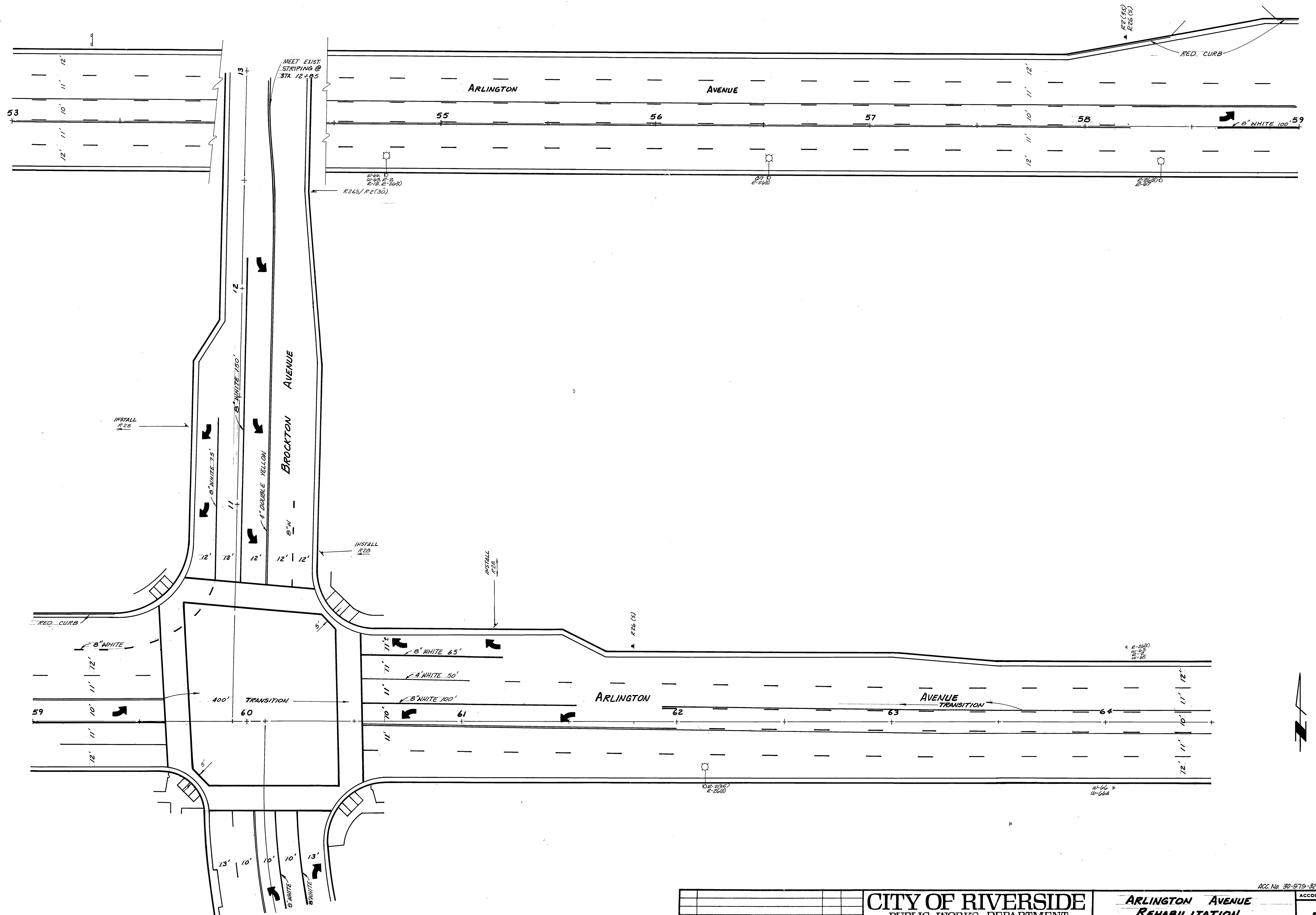

CITY OF RIVERSIDE PUBLIC WORKS DEPARTMENT				ACC. NO. 30-575-323 XL-168 ACCOUNT NO. 30-575-314-01	
				ARLINGTON AVENUE REHABILITATION STRIPING AND SIGNING	
APPROVED BY <small>PRINCIPAL ENGINEER</small> <i>[Signature]</i>		DATE 3-27-88		APPROVED BY <small>PUBLIC WORKS DIRECTOR</small> <i>[Signature]</i>	
TRAFFIC DIVISION <small>INSPECTION</small>		<small>DATE</small> 3/22/88		<small>DATE</small> MAR 22 1988	
DESIGNED BY <small>DRAWN BY</small>		CHECKED BY <small>D. Roy</small>		HORIZ. SCALE: 1" = 20' VERT. SCALE: 1" = 20'	
				SHEET 14 OF 21	

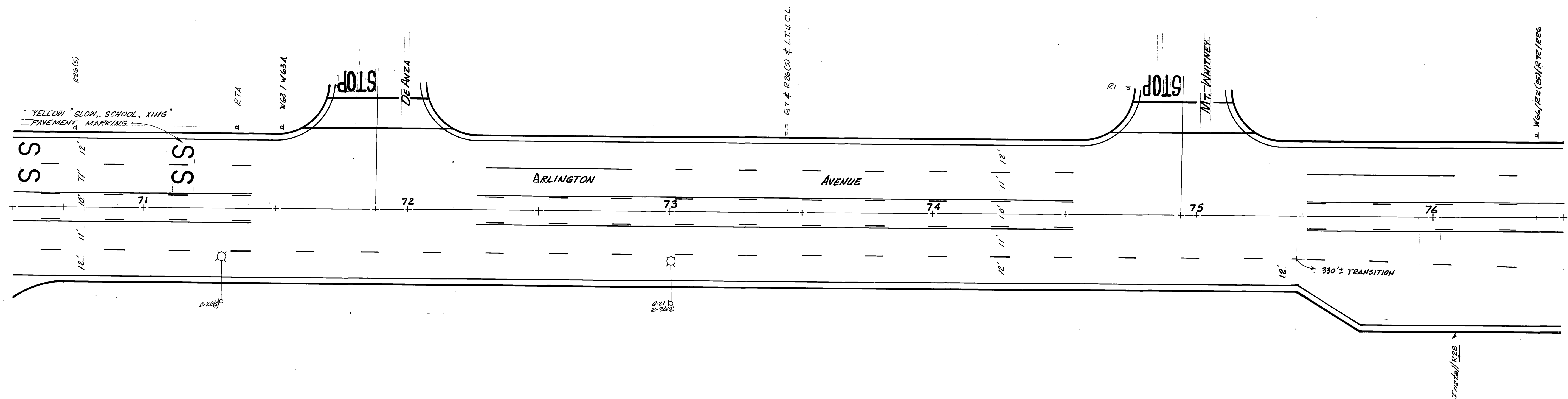
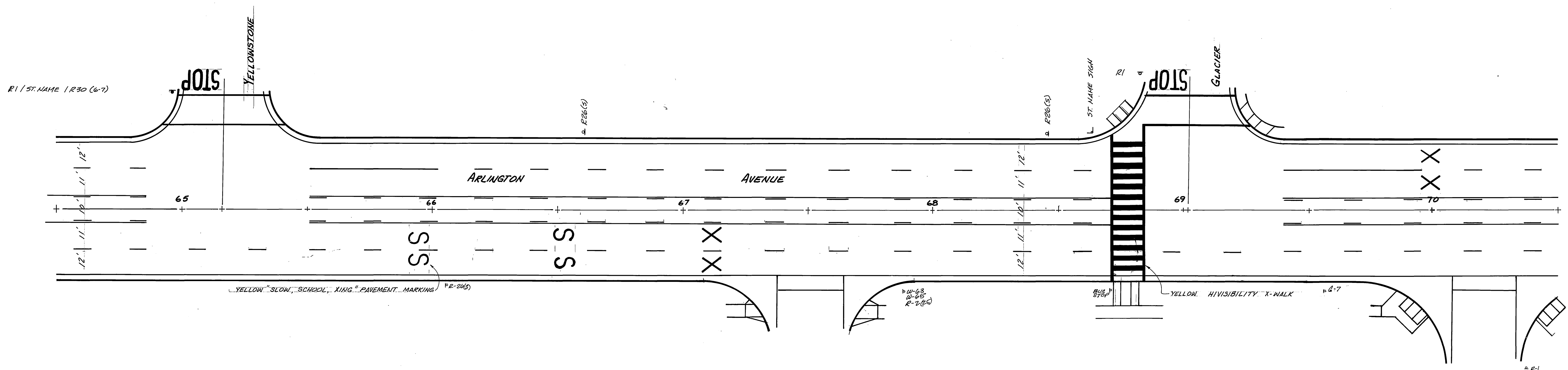

CITY OF RIVERSIDE PUBLIC WORKS DEPARTMENT		ARLINGTON AVENUE REHABILITATION STRIPING AND SIGNING		ACC. NO. 30-575-323 XL-168
APPROVED BY PRINCIPAL ENGINEER <i>[Signature]</i>	DATE 3-22-88	APPROVED BY PUBLIC WORKS DIRECTOR <i>[Signature]</i>	DATE 3-22-88	R-2459
DESIGNED BY DRAWN BY CHECKED BY	REVISIONS APPR. DATE	TRAFFIC DIVISION INSPECTION DEPUTY P.W. DIR.	DATE 3-22-88	SHEET 15 OF 21
HORIZ. SCALE: 1" = 20' VERT. SCALE: 1" = 20'			INDEXED 1-12-89	

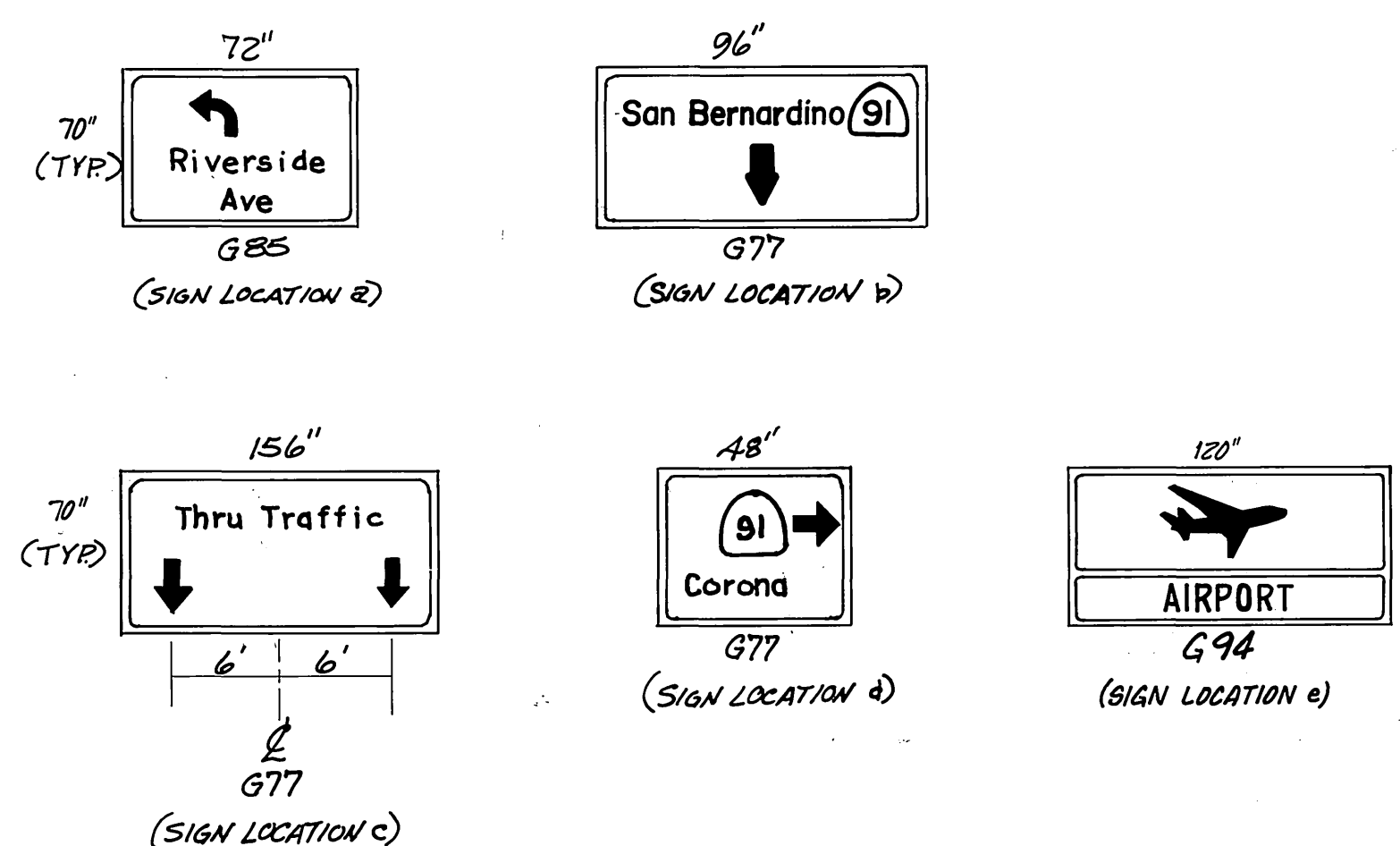
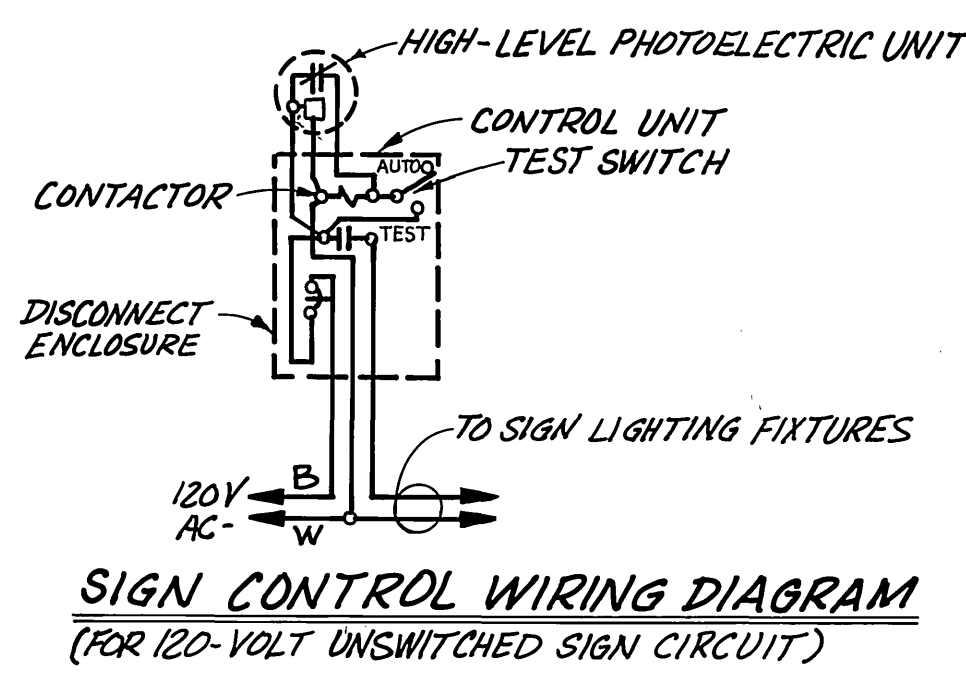
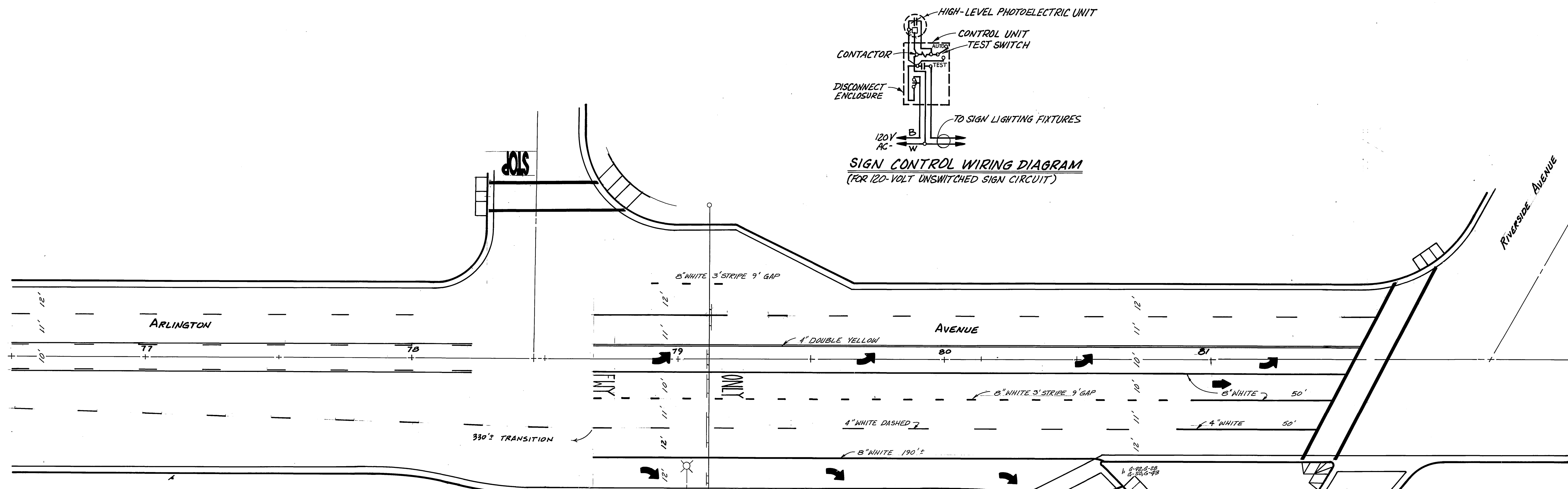

- GENERAL NOTES**
- LETTERS SHALL BE 8" UPPER CASE; 6" LOWER CASE.
 - COLOR IS WHITE LEGEND ON GREEN BACKGROUND.
 - PLACEMENT - SIGNS SHALL BE CENTERED OVER THE APPROPRIATE LANES.
 4. & IS LANE LINE FOR THRU TRAFFIC LANES (LOCATION C).

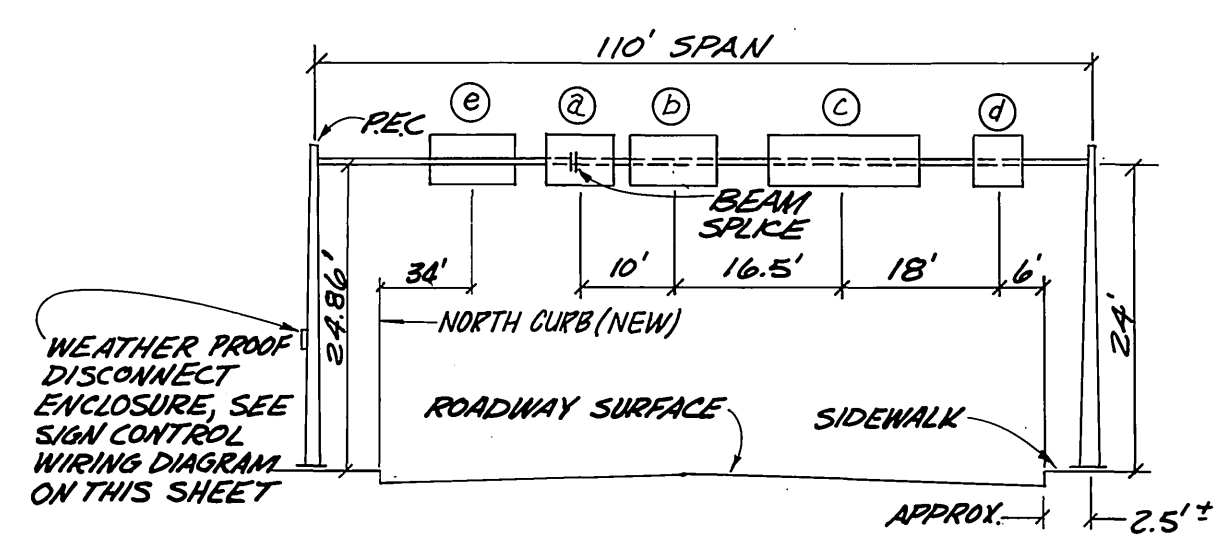

TUBULAR SIGN BRIDGE STRUCTURE
SCALE: NONE

NOTE: SEE PLAN R-2459 SHEET B OF 20 FOR TUBULAR SIGN BRIDGE STRUCTURE INSTALLATION LOCATION AND CIRCUITRY.

ACC. No. 30-975-323 **XL-16B**
ACCOUNT NO. 30-575-317-07

CITY OF RIVERSIDE PUBLIC WORKS DEPARTMENT				ARLINGTON AVENUE REHABILITATION STRIPINGS AND SIGNING		R-2459 SHEET 16 OF 21
				MAGNOLIA AVE. TO A.T. & S.F. R.R.		
APPROVED BY <small>PRINCIPAL ENGINEER</small> <small>DATE</small> 5-22-88	APPROVED BY <small>PUBLIC WORKS DIRECTOR</small> <i>[Signature]</i>	DESIGNED BY <small>DRAWN BY</small> JH <small>CHECKED BY</small> D. G.	DATE 11/21/88	HORIZ. SCALE: 1" = 20' VERT. SCALE: 1" = 20'	INDEXED 1-12-89 46	

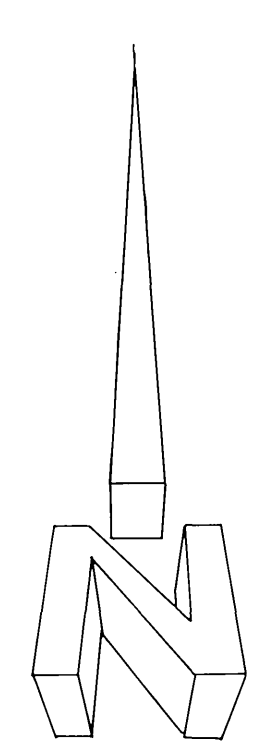
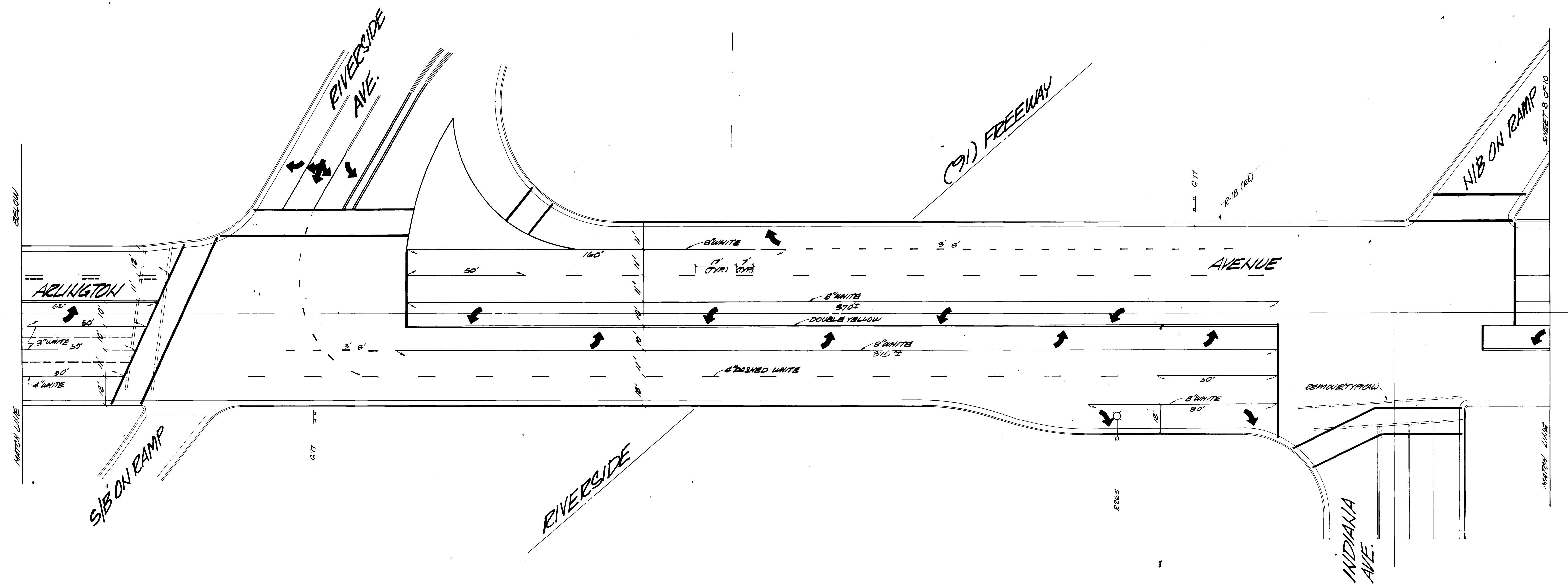

NL-168
ACC. No. 30-579-323

CITY OF RIVERSIDE PUBLIC WORKS DEPARTMENT				STRIPING PLAN ARLINGTON AVENUE REHABILITATION MAGNOLIA AVE. TO AT. & S.F. R.R.		ACCOUNT NO. 30-579-314-07 R-2459 SHEET 17 OF 21	
APPROVED BY PRINCIPAL ENGINEER	DATE 5-21-88	BY <i>[Signature]</i>	APPROVED BY PUBLIC WORKS DIRECTOR	RCE # 18,791	DATE May 22, 1988	HORIZ. SCALE: 1" = 20' VERT. SCALE: 1" =	INDEXED 1-12-89 LFF
TRAFFIC DIVISION INSPECTION DEPUTY PW DIR	3/4/88 3/21/88 3-22-88	APPR. DATE 3/21/88	DESIGNED BY DRAWN BY CHECKED BY	3/21/88 3/21/88 3-22-88	3/21/88	3/21/88	3/21/88

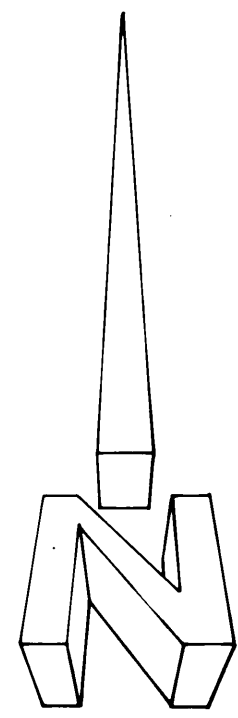
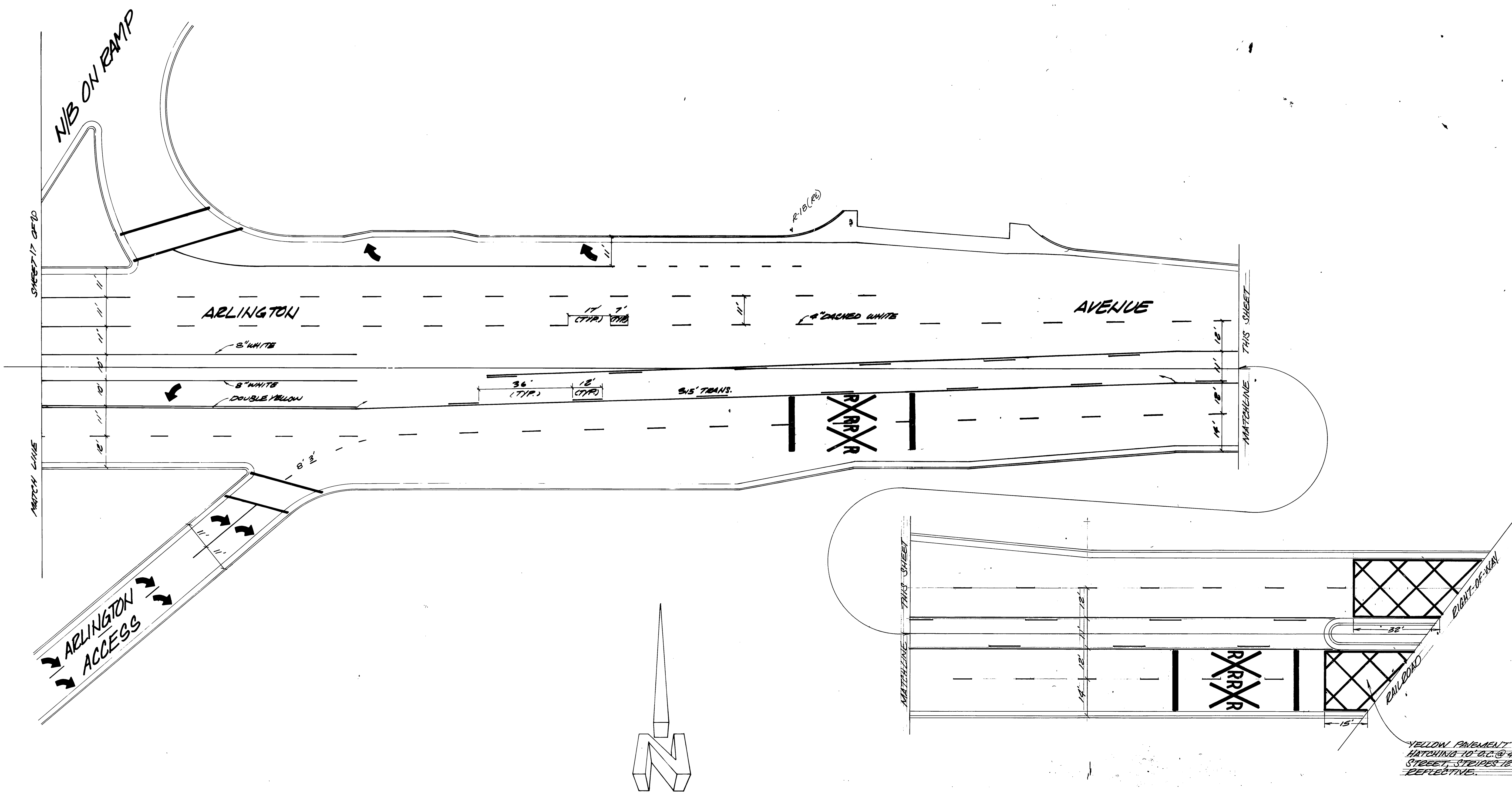

YELLOW PAVEMENT CROSS
HATCHING 10" O.C. @ 45° TO
STREET. STRIPES 12" WIDE,
REFLECTIVE.

CITY OF RIVERSIDE PUBLIC WORKS DEPARTMENT				STRIPPING PLAN		ACCOUNT NO. 30-919-323
				ARLINGTON AVENUE REHABILITATION		R-2459
DESIGNED BY	DRAWN BY	CHECKED BY	APPROVED BY	DATE	HORIZ. SCALE: 1" = 20'	VERT. SCALE: 1" =
REVISIONS	APPR. DATE	INSPECTION	TRAFFIC DIVISION	DATE		