

**PAVEMENT DELINEATION AND SIGNING LEGEND**

- EXISTING SIGNS ON EXISTING ROADWAYS TO BE REMOVED AND SALVAGED IN ACCORDANCE WITH THE SPECIAL PROVISIONS.
- R30/R81 SIGN COMBINATION SHALL READ AS SHOWN ON DETAIL "A".

- (A) 4" SOLID WHITE STRIPE
- (B) 4" DASH WHITE STRIPE ( 12' STRIPE, 36' GAP )
- (C) 6" SOLID WHITE STRIPE
- (D) 6" DASH WHITE STRIPE ( 4' STRIPE, 8' GAP )
- (E) 8" SOLID WHITE STRIPE
- (F) SOLID WHITE ARROW
- (G) SOLID WHITE BIKE LANE STENCIL W/ ARROW
- (H) 12" SOLID WHITE STRIPE
- (I) 12" SOLID YELLOW STRIPE

(S) INDICATES NEW SIGN(S) TO BE FURNISHED AND INSTALLED BY CONTRACTOR ON ST. LT. STD OR EXISTING POST.

(S) INDICATES EXISTING SIGN(S) TO BE RELOCATED

(666) INDICATES NEW SIGN(S) AND POST TO BE FURNISHED AND INSTALLED BY CONTRACTOR PER STD. DWG. NO. 666.

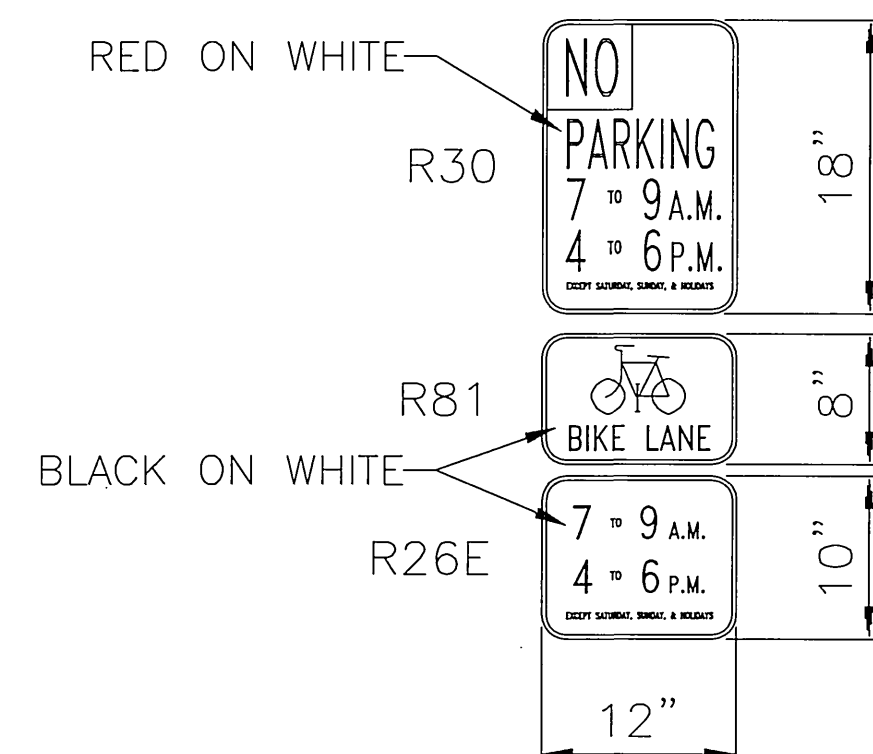

DETAIL "A"

**ENGINEER IN RESPONSIBLE CHARGE**  
 THOMAS J. BOYD  
 R.C.E. No. 36170 expires 6/30/04  
 DATE 4/9/00

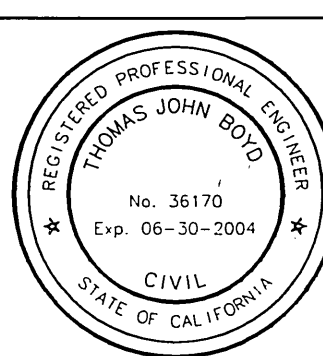

CITY OF RIVERSIDE, CALIFORNIA DEPARTMENT OF PUBLIC WORKS	
APPROVED BY	BY DATE
DEPUTY P.M. DIR./ENR.	THB/ulm
P.M. INSPECTION	R.M. Smith
TRAFFIC DIVISION	DATE 11-16-2000
CHIEF P.W. ENGR.	
PUBLIC UTILITIES	

PAVEMENT DELINEATION & SIGNS	ACCT. NO. 9534427152-44022300
<b>LA SIERRA AVENUE WIDENING</b>	<b>XL-415</b>
GRAMERCY TO ARLINGTON	SHEET 1 OF 3
SCALE: 1" = 40'	FILE NAME: XL415-1.DWG

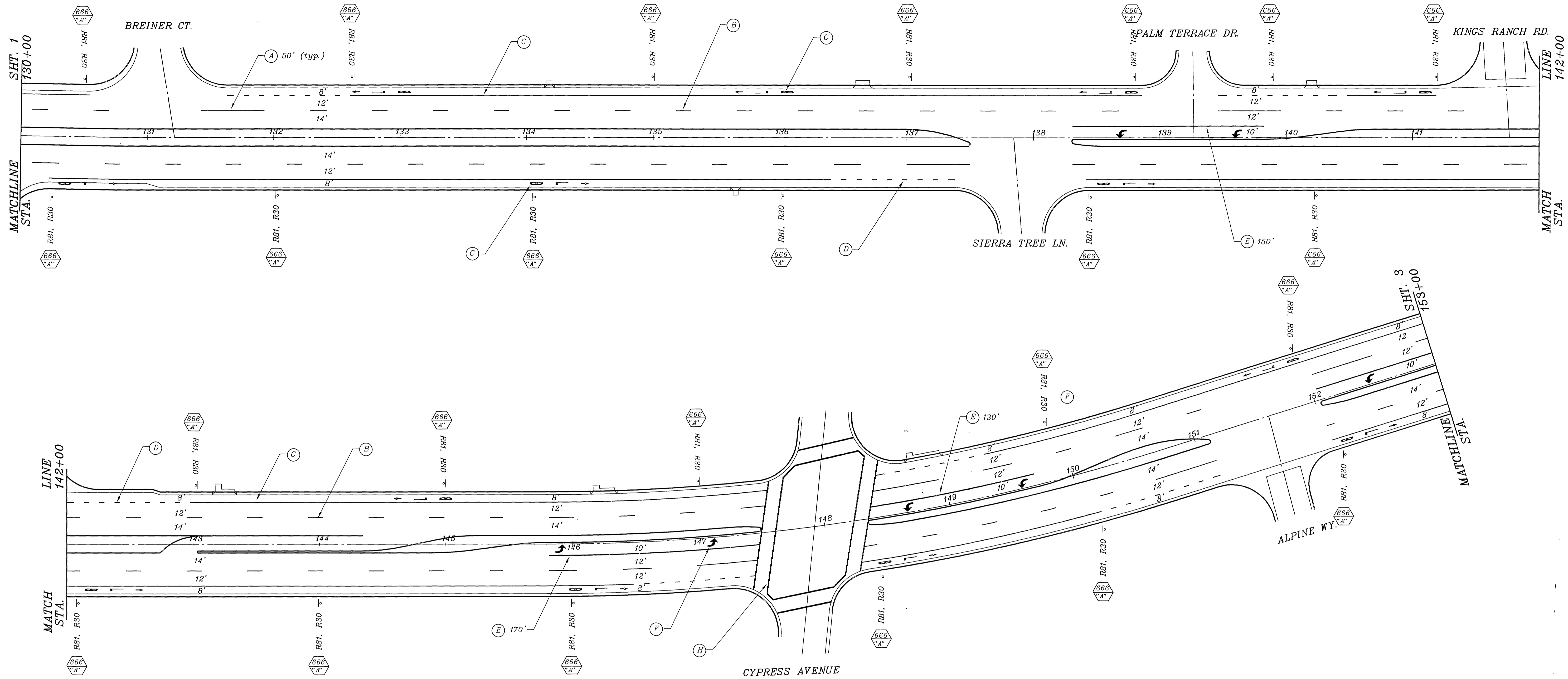

**PAVEMENT DELINEATION AND SIGNING LEGEND**

- EXISTING SIGNS ON EXISTING ROADWAYS TO BE REMOVED AND SALVAGED IN ACCORDANCE WITH THE SPECIAL PROVISIONS.
- R30/R81 SIGN COMBINATION SHALL READ AS SHOWN ON DETAIL "A".

- (A) 4" SOLID WHITE STRIPE
- (B) 4" DASH WHITE STRIPE ( 12' STRIPE, 36' GAP )
- (C) 6" SOLID WHITE STRIPE
- (D) 6" DASH WHITE STRIPE ( 4' STRIPE, 8' GAP )
- (E) 8" SOLID WHITE STRIPE
- (F) SOLID WHITE ARROW
- (G) SOLID WHITE BIKE LANE STENCIL W/ ARROW
- (H) 12" SOLID WHITE STRIPE
- (I) 12" SOLID YELLOW STRIPE

(S/N) INDICATES NEW SIGN(S) TO BE FURNISHED AND INSTALLED BY CONTRACTOR ON ST. LT. STD OR EXISTING POST.

(S/E) INDICATES EXISTING SIGN(S) TO BE RELOCATED

(666/N) INDICATES NEW SIGN(S) AND POST TO BE FURNISHED AND INSTALLED BY CONTRACTOR PER STD. DWG. NO. 666.

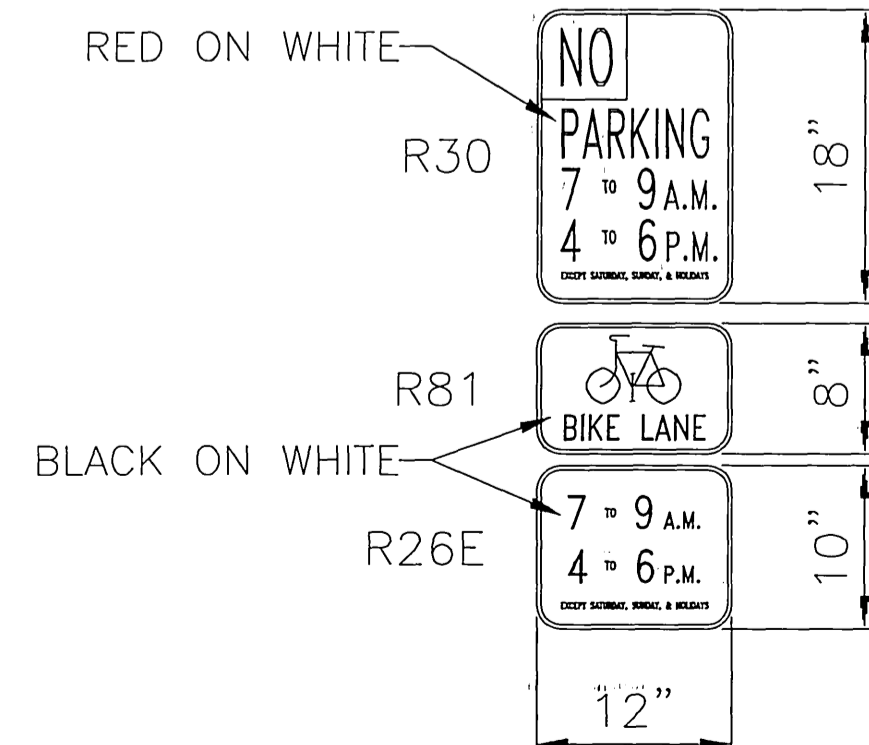

**DETAIL "A"**

**ENGINEER IN RESPONSIBLE CHARGE**  
 THOMAS J. BOYD  
 R.C.E. No. 36170 expires 6/30/04  
 DATE 4/9/00

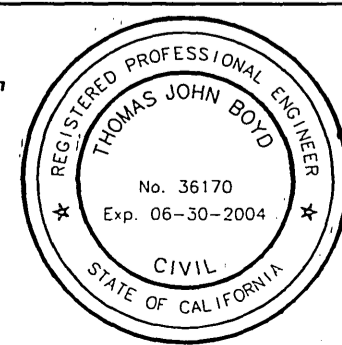

MARK	REVISIONS	APPR	DATE

CITY OF RIVERSIDE, CALIFORNIA DEPARTMENT OF PUBLIC WORKS			
APPROVED BY	BY	DATE	APPROVED BY
DEPUTY P.W. DIR./ENGR.			
P.W. INSPECTION			
TRAFFIC DIVISION			
CHIEF P.W. ENGR.			
PUBLIC UTILITIES			

**PAVEMENT DELINEATION & SIGNS**  
**LA SIERRA AVENUE WIDENING**  
 GRAMERCY TO ARLINGTON  
 SCALE: 1" = 40'

ACCT. NO. 9534427152-44022300  
**XL-415**  
 SHEET 2 OF 3  
 FILE NAME: XL415-2.DWG

2 11/4/00

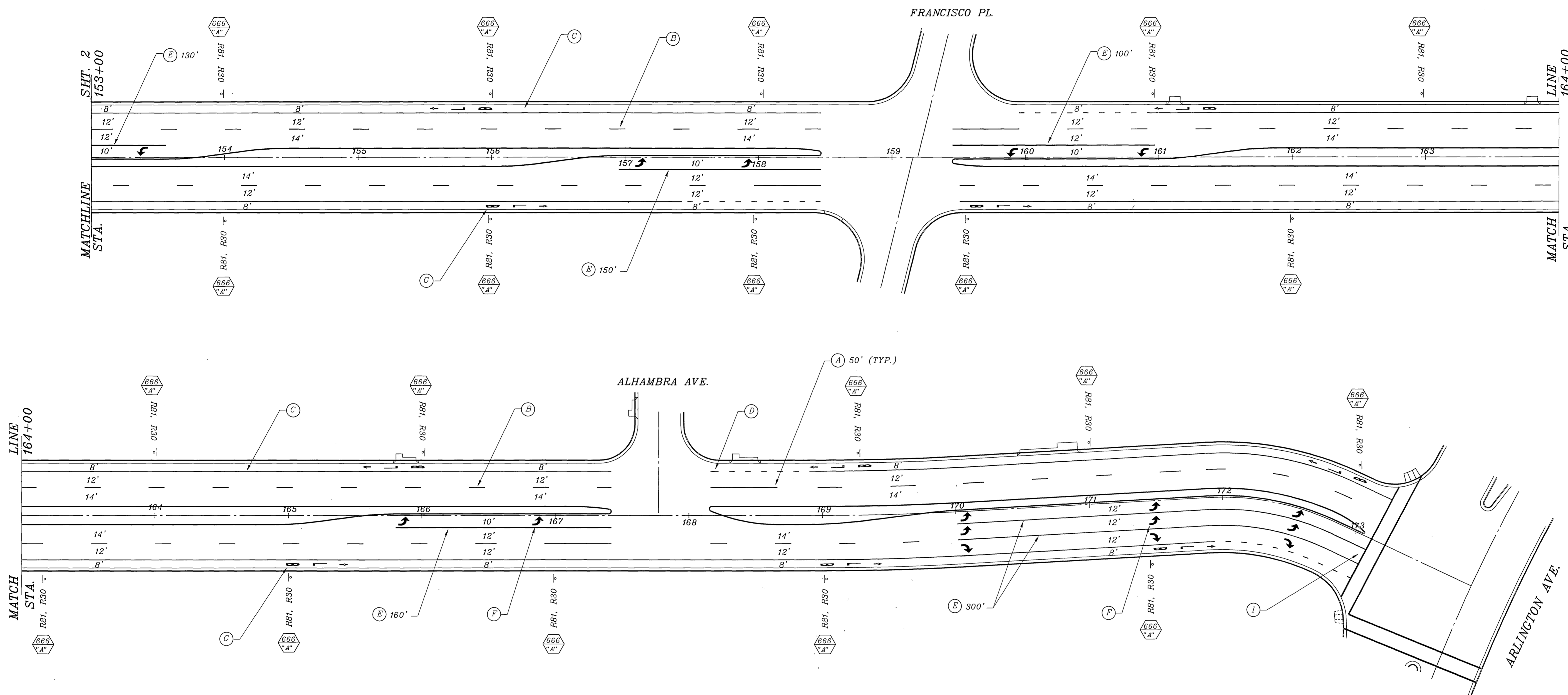

**PAVEMENT DELINEATION AND SIGNING LEGEND**

- EXISTING SIGNS ON EXISTING ROADWAYS TO BE REMOVED AND SALVAGED IN ACCORDANCE WITH THE SPECIAL PROVISIONS.
- R30/R81 SIGN COMBINATION SHALL READ AS SHOWN ON DETAIL "A".

- (A) 4" SOLID WHITE STRIPE
- (B) 4" DASH WHITE STRIPE ( 12' STRIPE, 36' GAP )
- (C) 6" SOLID WHITE STRIPE
- (D) 6" DASH WHITE STRIPE ( 4' STRIPE, 8' GAP )
- (E) 8" SOLID WHITE STRIPE
- (F) SOLID WHITE ARROW
- (G) SOLID WHITE BIKE LANE STENCIL W/ ARROW
- (H) 12" SOLID WHITE STRIPE
- (I) 12" SOLID YELLOW STRIPE

(S) INDICATES NEW SIGN(S) TO BE FURNISHED AND INSTALLED BY CONTRACTOR ON ST. LT. STD OR EXISTING POST.

(S) INDICATES EXISTING SIGN(S) TO RELOCATED

(666) INDICATES NEW SIGN(S) AND POST TO BE FURNISHED AND INSTALLED BY CONTRACTOR PER STD. DWG. NO. 666.

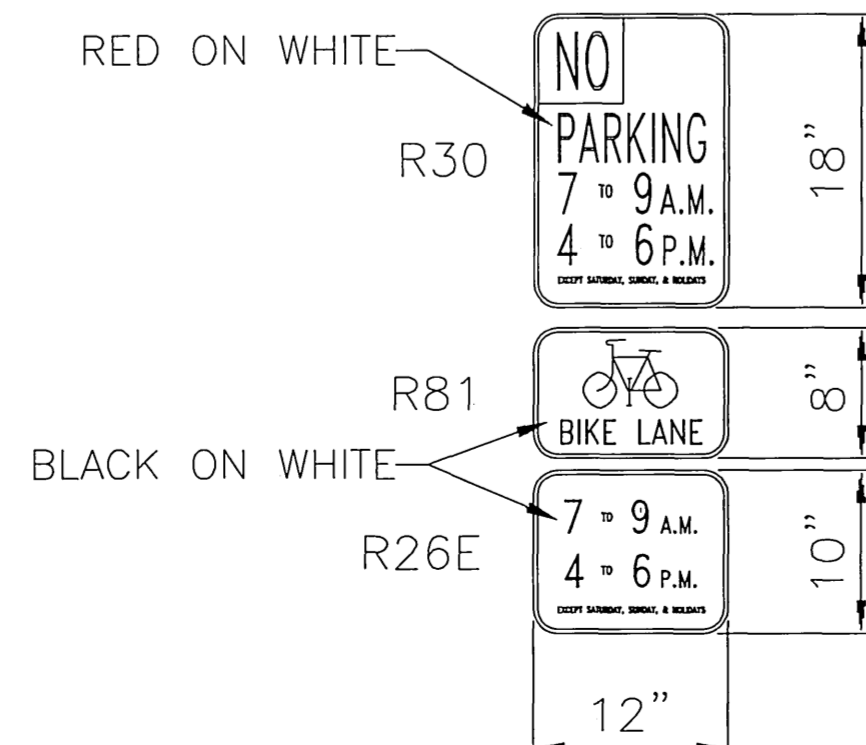

DETAIL "A"

	<b>ENGINEER IN RESPONSIBLE CHARGE</b> <i>Thomas J. Boyd</i> THOMAS J. BOYD R.C.E. No. 36170 expires 6/30/04 DATE 11/9/00		CITY OF RIVERSIDE, CALIFORNIA DEPARTMENT OF PUBLIC WORKS		PAVEMENT DELINEATION & SIGNS <b>LA SIERRA AVENUE WIDENING</b> GRAMERCY TO ARLINGTON SCALE: 1" = 40'	ACCT. NO. 9534427152-44022300 <b>XL-415</b> SHEET 3 OF 3 FILE NAME: XL415-3.DWG
	DESIGNED BY: MAC DRAWN BY: MAC CHECKED BY:	REVISIONS APPR. DATE	APPROVED BY: [Signature] DEPUTY P.W. DIR./ENGR. P.W. INSPECTION TRAFFIC DIVISION CHIEF P.W. ENGR. PUBLIC UTILITIES	BY: [Signature] DATE: 11-16-2000	APPROVED BY: [Signature] DIRECTOR OF PUBLIC WORKS	